

Electrical installation solutions for buildings – Technical details

Control and automation

Index

AG Timer electro-mechanical time switches	7/2
DBT Timer digital time switches	7/5
E 232 staircase lighting time-delay switches	7/11
E 234 CT-D time relays for building applications	7/12
TL Line twilight switches	7/21
LCR load management relay	7/24

Control and automation technical details

AG Timer electro-mechanical time switches

How to program AD1NO-15m - AD1NO-R-15m

Connection diagrams

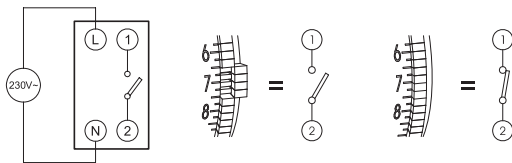

Description

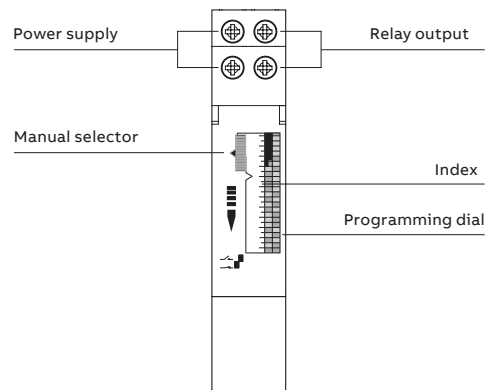

How to program AD1CO-15m - AD1CO-R-15m - AW1CO-R-120m

Connection diagrams

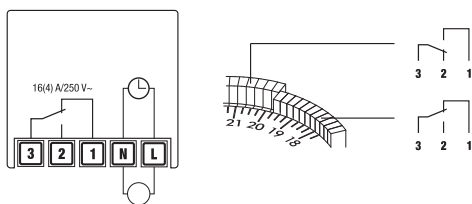

Description

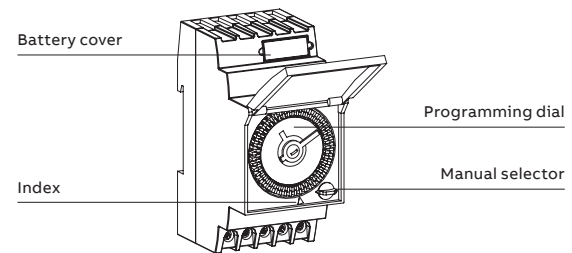

How to program AD1CO-30m - AD1CO-R-30m - AW1CO-R-210m

Connection diagrams

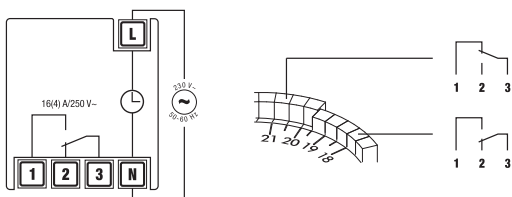

Description

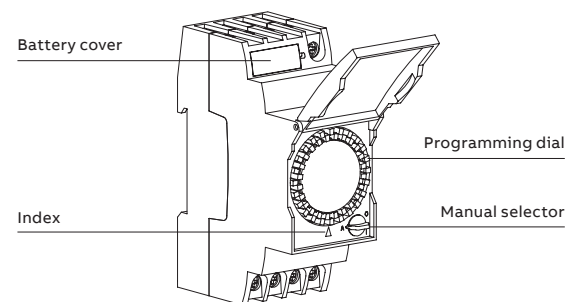

How to program AD1-R-15m-72

Connection diagrams

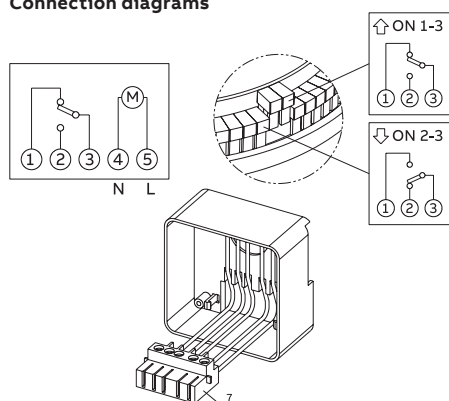

Description

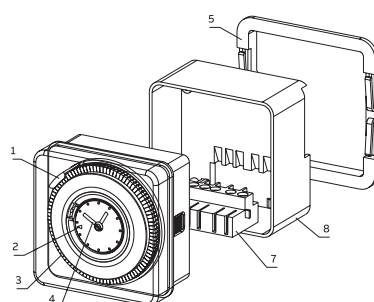

- 1 - Selector switch
- 2 - Indicator
- 3 - Trippers for programming
- 4 - Trippers for programming
- 5 - Accessory for panel mounting
- 6 - Transparent protection cover
- 7 - Extractable terminal block
- 8 - Accessory for wall or DIN rail installation

Control and automation technical details

AG Timer electro-mechanical time switches

AG Timer with DIN rail mounting

Operating principle

The AG Timer electro-mechanical time switches enable to control the circuit opening/closing according to a daily or weekly program or to manually set permanent ON/OFF operation.

Application environments

The AG Timer electro-mechanical time switches are particularly indicated in any environment and situation where it is necessary to program system load operation according to a daily or weekly frequency (shop lighting system, public buildings, heating systems, irrigation systems, etc.).

Example of installation

As shown in the diagrams, one of the possible applications is to mount the AW1CO-R-120m electro-mechanical time switch inside the power supply circuit of a golf field. In this case the device programming enables the daily activation of the irrigation system at a preset time.

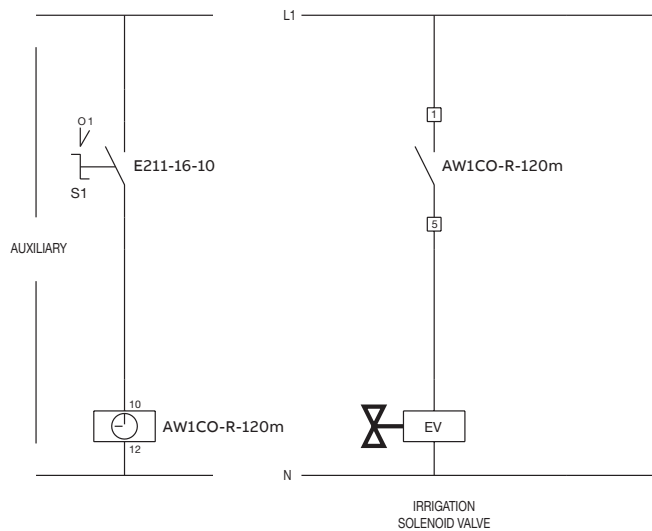
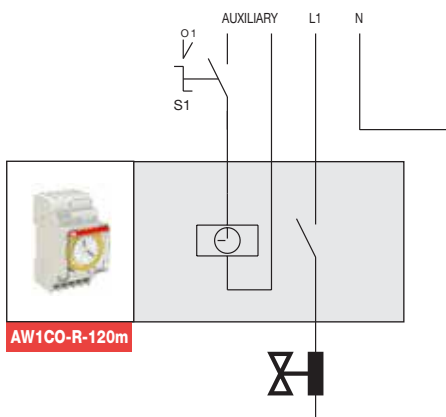
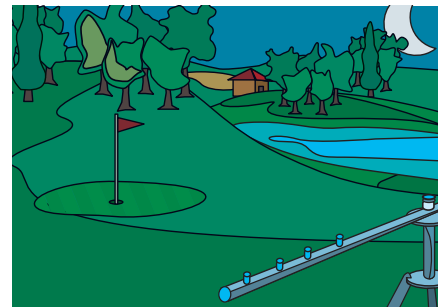
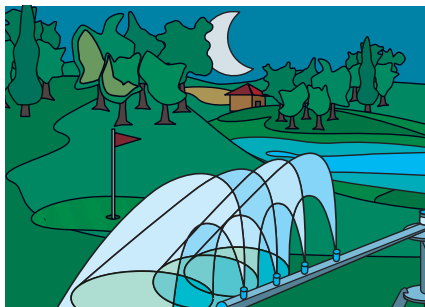

Control and automation technical details

AG Timer electro-mechanical time switches

AG Timer with panel/wall mounting

Operating principle

The AD1-R-15m-72 electro-mechanical switch enables to control the circuit opening/closing according to a daily program or to manually set permanent ON/OFF operation.

Application environments

The AD1-R-15m-72 electro-mechanical time switch is particularly indicated in any environment and situation where it is necessary to program system load operation according to a daily frequency (lighting system, heating systems, venting systems, etc.).

Example of installation

One of the possible applications is to use the AD1-R-15m-72 to command the heating activation at specific times during the day, allowing energy saving.

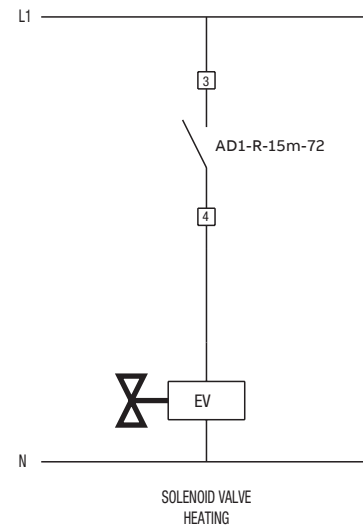
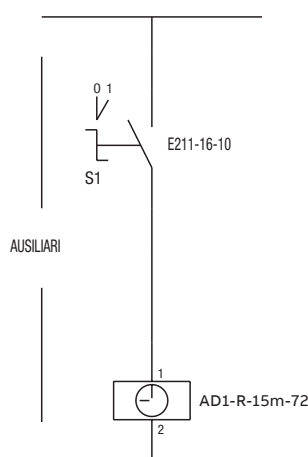
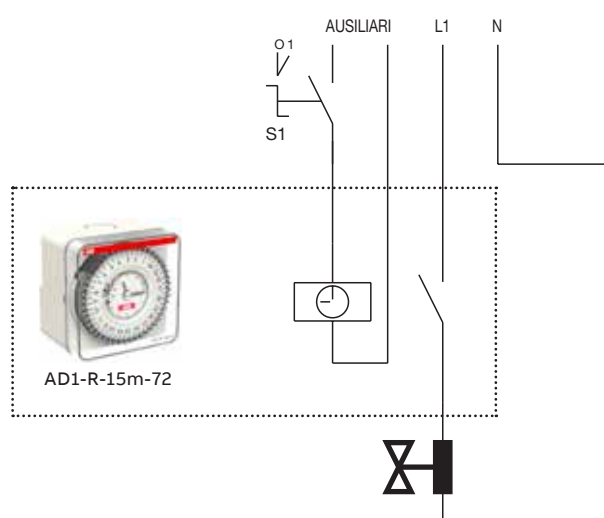

Control and automation technical details

DBT Timer digital time switches

Innovations

- DBT Timer range is equipped with impulse, cycle, random and holiday programs. They can have daily, weekly or annual mode.
- Holiday management with the possibility of programming them in various period throughout the year
- Menu programming with 4 simple keys
- Astronomical management allows automatic setting, for each day of the year, of sunrise and sunset times
- Minimum switching time is 1 second for pulse program
- Multilingual menu with 6 language choices



Bluetooth communication combined with the DBT Timer APP available for Android and iOS ensure smart configuration and quick visualization. This functionality also allows to transfer programs from one device to another simply using the Smartphone.



The DY DCF77 antenna that receives the DCF77 radio synchronisation signal transmitted by the atomic clock installed c/o Mainflingen, near Frankfurt, increases digital clock precision.

The DY GPS antenna that receives time from the Global Positioning System, that offers a more accurate value than land transmissions in addition to the possibility of receiving the signal anywhere in the world.

Control and automation technical details

DBT Timer digital time switches

Display description

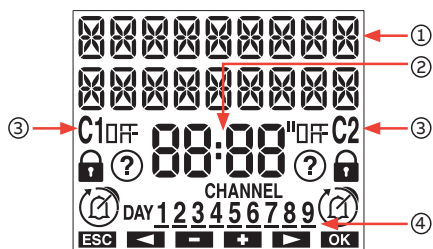

Description
1 General indications
2 Time indication
Channel 1 / Channel 2 status indication □ _n /OFF
⌚ Active manual program
⌚ + 🔒 Blocked switchings
3 ⌚ + ⌚ Active random switchings
⌚ + □ _n /OFF (flashing): active cycle switchings
📅 Active holiday program
🔔 Active pulse program
4 Day of the week (DAY) indication

Access to device

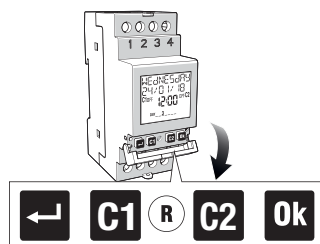

Button	Function
←	Turn on the display Access the menu ESC (one level back)
C1	Decrease datum Previous menu Switching channel 1 Lock channel 1
C2	Increase datum Next menu Switching channel 2 Lock channel 2
Ok	Confirm selection
R	Hardware reset
C1 + Ok 3 sec	Random switching channel 1
C2 + Ok 3 sec	Random switching channel 2
← + C1 3 sec	Active cycle switching on channel 1
← + C2 3 sec	Active cycle switching on channel 2

Menu description

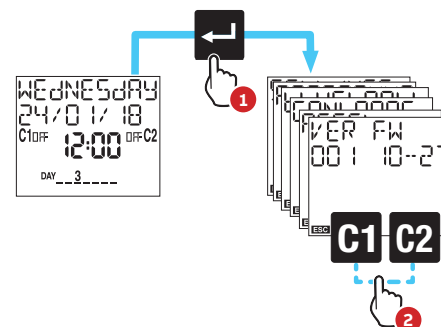

Menu	Description
Settings	Allows to change: language, date, time, daylight saving time (DST), astronomical coordinates, minimum and maximum duration of the interval between two switchings with random program, ON and OFF duration of cycle switchings and PIN for keyboard lock
Program	Allows to create a new program, check created programs, change or delete a created program, copy all created programs of channel 1 on channel 2 and vice versa.
Bluetooth	Allows to enable or disable the Bluetooth interface and to change the password used to associate devices (smartphone)
Hour counter	Allows to display the hours of usage (relay on) of connected load(s).
Reset	Allows to restore the initial state of the device
Firmware menu	Shows the firmware installed in the device

Control and automation technical details

DBT Timer digital time switches

DY DCF77 antenna

Operating principle:

This antenna receives scheduled messages broadcasted from the Frankfurt on Main (Germany) based DCF77 emitter.

Thanks to this signal, the time switches are automatically set to: hour, date and proper daylight saving time.

The broadcast power is 50 kW and the range is approximately 2500 kilometers from Frankfurt on Main.

The signal is sometimes received intermittently and not in all locations, especially in countries far enough from the DCF77 emitter.

For optimal signal reception the arrow marked side of the antenna must be rotated towards Frankfurt on Main.

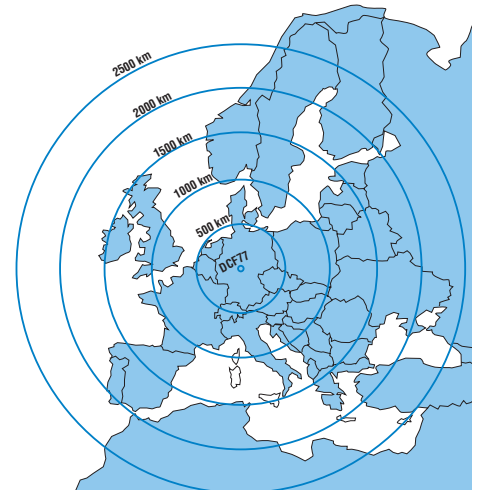

DY GPS antenna

Operating principle:

The Global Positioning System provides an accurate location and time information for an unlimited number of people in all weather, day or night, anywhere in the world.

The synchronization received from GPS is far more precise regarding to terrestrial broadcast.

The GPS system relies upon time from satellite based atomic clocks, constantly controlled and corrected from a ground stations network.

The time is derived from different sources simultaneously, the digital time switches can automatically compensate for propagation delays and other problems by providing more precise values than terrestrial.

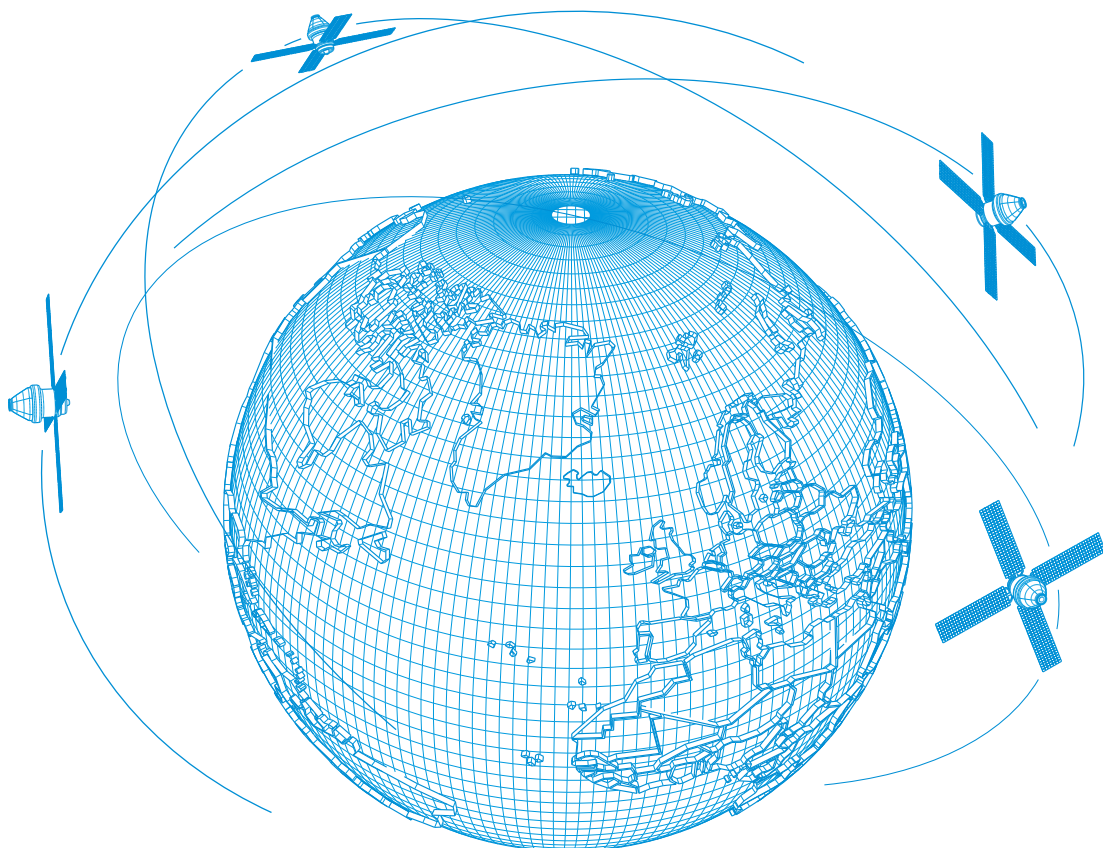

Control and automation technical details

DBT Timer digital time switches

Operating principle

The DW2 two-channel digital weekly time switch enables to open and close circuits according to a daily or weekly program, controlling single loads or group ones even when they require different time controls with a common time reference. In this example, the digital time switch DW2 allows the operation of heating as well as lighting systems of a church when services are performed; when no service is performed, the device only controls the heating system.

Application environments

The DW2 two-channel digital weekly time switch is particularly indicated in environments and situations requiring the management of multiple loads according to a time program flexible enough to include or exclude their application based on the day of the week (offices, schools, public areas, etc.).

Example of installation

As shown in the diagrams, one of the possible applications is to mount the DW2 two-channel digital weekly time switch inside the power supply circuit of a church, where in the days when no service is performed only the heating system is activated (programmed on one of the two channels) at a preset time, while on Sundays and when services are performed the lighting system is also switched on (through a program on the second channel). According to the controlled system power, the activation is performed by an ESB contactor.

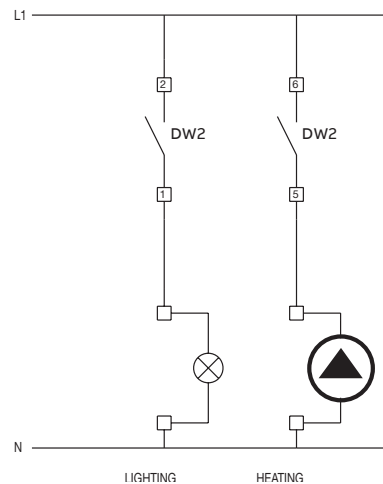
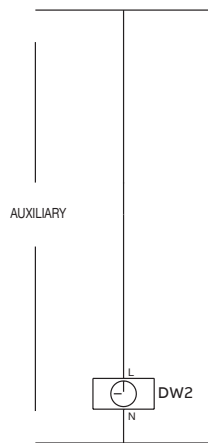
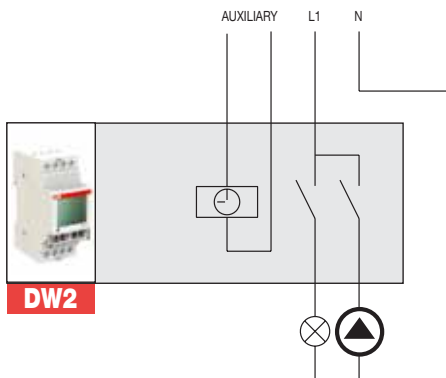
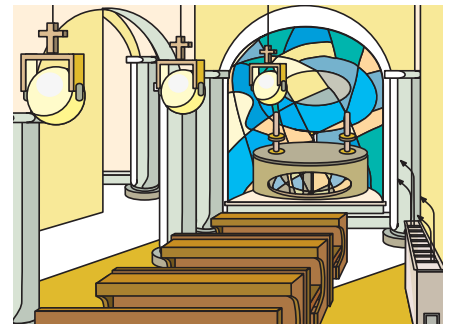
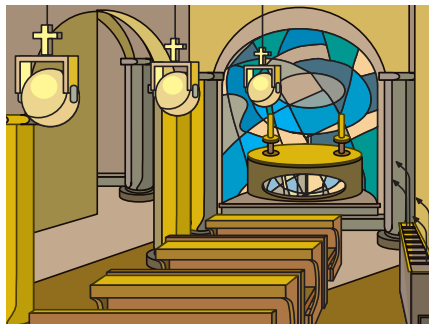
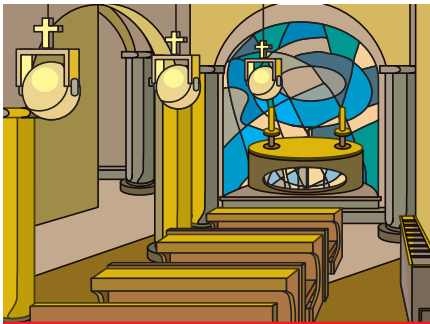

Control and automation technical details

DBT Timer digital time switches



DWA2

Astronomical version – DWA

- Astronomical and time programming
- Impulse, cycle, random and holiday program
- Automatic summer and winter time change
- Up to 120 storable events
- Opportunity to correct the astronomical time up to ±120 min
- Up to 400 pre-defined cities
- 1 or 2 changeover contacts
- latitude adjustment range from +90° North to -90° South.
- longitude adjustment range from 180° East to 180° West.
- Manual and permanent override, activated with one touch on the front of the device
- Clear display of contact status
- Unlosable hinged window
- The protection code PIN is used to prevent interference by unauthorised persons
- Android and iOS application for quick and ease programming
- Wiring diagram printed on the side of the product

Programming example

Ex: Rome

- Lo** Longitude 12° EAST
- La** Latitude 41° NORTH
- UDT** +1 Universal Date Time = +1 hour

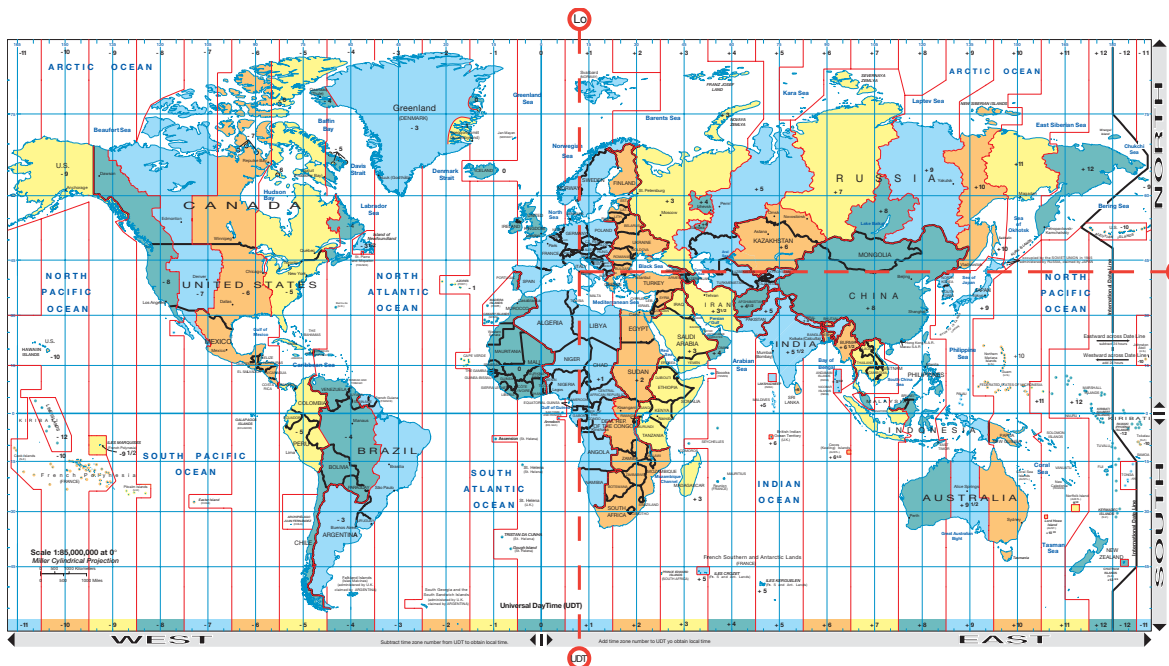
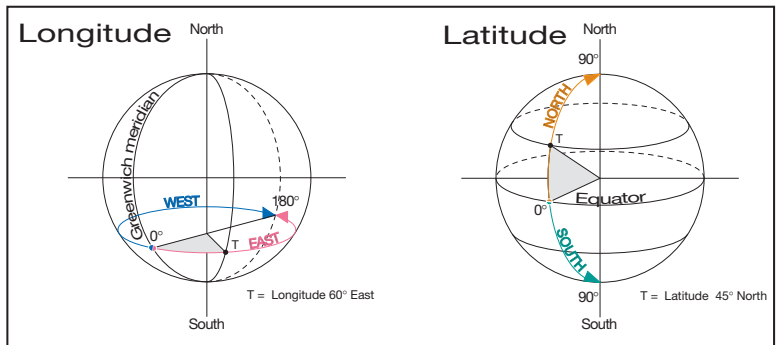

Control and automation technical details

DBT Timer digital time switches

Operating principle

The installation of an astronomical time switch in a system is a particularly useful addition for settings and situations in which light sources, or other environmental conditions, can cause changes in the brightness level and falsify the reading. In these cases, the DWA1 and DWA2 astronomical switches can control the lighting system according to the sunrise and sunset times of the geographic zone in which the system is installed.

Application environments

The installation of the DWA1 and DWA2 astronomical time switches is particularly suitable for applications in which the operation of a twilight switch with external probe can be falsified or compromised by external agents (such as environmental pollution, overexposure to light, vandalism, etc.).

Example of installation

Atmospheric pollution is one of the causes of a reduction in

the level of environmental light. Dust deposits on the external probe of a traditional twilight switch can compromise the operation of the device, preventing it from automatically switching off the controlled lighting system in the presence of external light.

As shown in the example, this problem can be solved by installing a DWA1 astronomical time switch that controls the lighting system according to the level of light calculated from the preset longitude and latitude parameters.

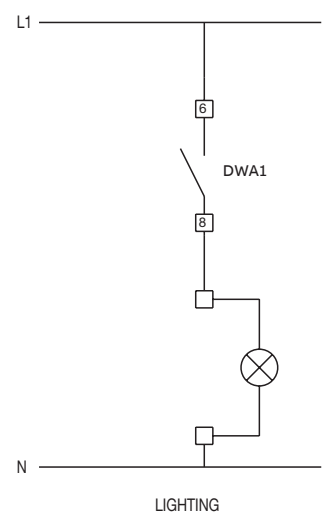
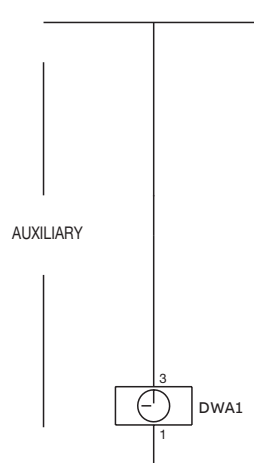
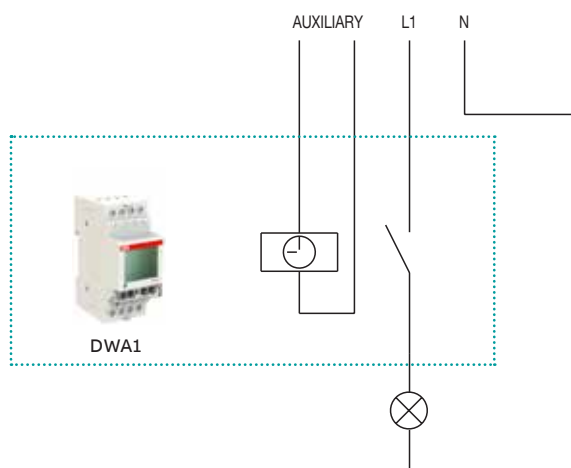
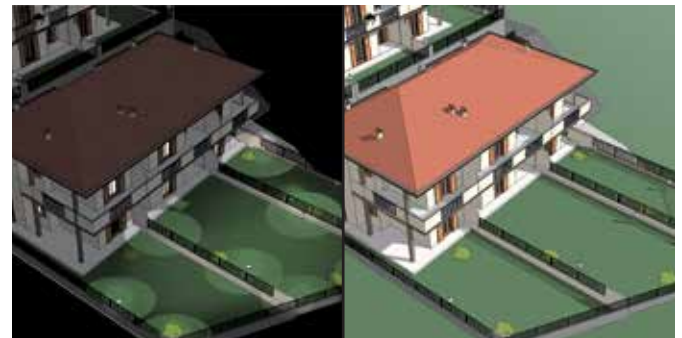
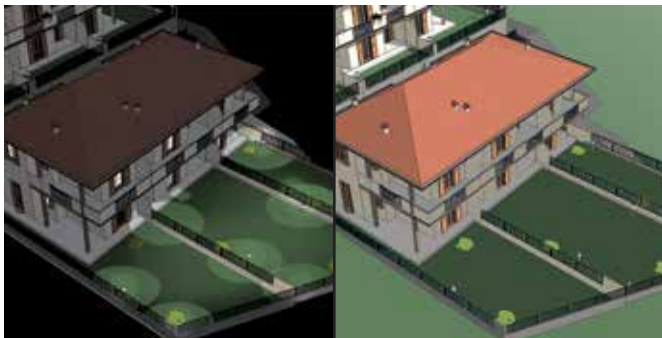

Control and automation technical details

E 232 staircase lighting time-delay switches

E 232E-230 Multi 10, 8/230 Multi 10

Functions: Staircase lighting time-delay switch

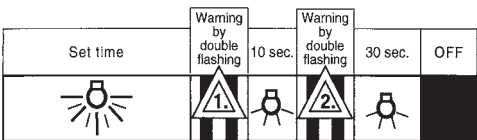
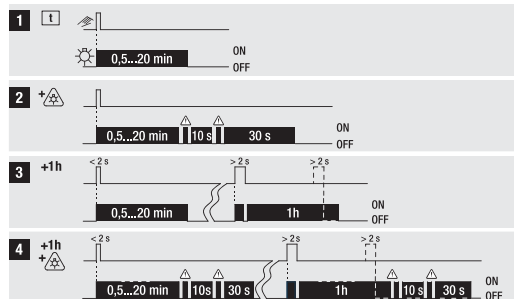

E232E-230 Multi10 and E232E-8/230 Multi10

Function: Latching relay, Latching relay with returning time

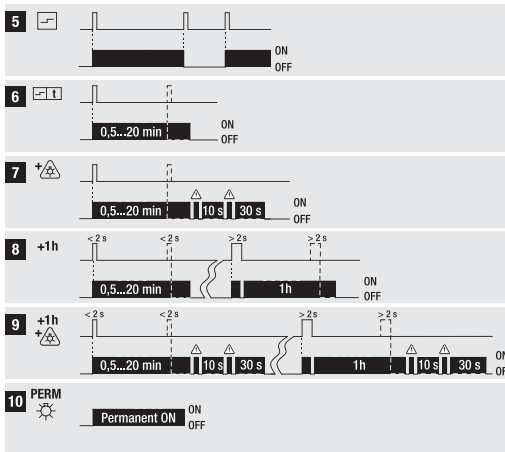

DIN 18015-2

provides that "that the automatic disconnection of lighting equipment fitted in staircases of apartment buildings must provide for warning signals, e.g. dimming, in order to avoid sudden unexpected darkness".

Operating principle

Activated by a pulse command through a pushbutton, the E 232 staircase light switch turns on the installation's lights for a time T1. In order to avoid an unexpected darkness, the Multi10 devices are equipped with a switch-off warning (double flash).

Application environments

Installation of the E 232 staircase lighting with switch-off warning functionality is ideal wherever the lighting must be timed and unexpected darkness must be avoided (staircases

and passageways in public places, cellars, garages, etc.).

Example of installation

One of possible applications of the E 232E-230 Multi 10 staircase switch is in the staircase lighting plant of a multistory building. Pushing the push-button, the timer of the E 232E-230 Multi 10 switch turns on the lights for a settable T1 time. At the end of the time the device gives a prewarning by blinking that the set time expires. The user can restart the timer again by pressing the button.



Control and automation technical details

E 234 CT-D time relays for building applications

Remarks

Legend

- Control supply voltage not applied / Output contact open
- Control supply voltage applied / Output contact closed
- A1-Y1/B1 Control input with voltage-related triggering

Terminal designations on the device and in the diagrams

- The 1st c/o contact is always designated **15-17/18**.
- The 2nd c/o contact is designated **25-27/28**.
- The n/o contacts of the star-delta timers are designated with **17-18** and **17-28**.
- Control supply voltage is always applied to terminals **A1-A2**.

Function of the yellow LED

The yellow LED **R** glows as soon as the output relay energizes and turns off when the output relay de-energizes.



**ON-delay
(Delay on make)
CT-ERD, CT-MFD**

This function requires continuous control supply voltage for timing. Timing begins when control supply voltage is applied. The green LED flashes during timing. When the selected time delay is complete, the output relay energizes and the flashing green LED turns steady. If control supply voltage is interrupted, the output relay de-energizes and the time delay is reset. Control input **A1-Y1/B1** of the CT-MFD is disabled when this function is selected.

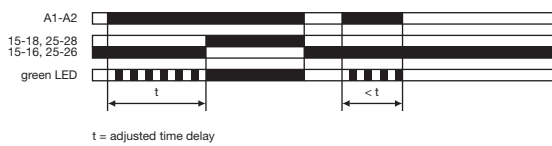

**OFF-delay with auxiliary voltage
(Delay on break)
CT-AHD, CT-MFD**

This function requires continuous control supply voltage for timing. If control input **A1-Y1/B1** is closed, the output relay energizes immediately. If control input **A1-Y1/B1** is opened, the time delay starts. The green LED flashes during timing. When the selected time delay is complete, the output relay de-energizes and the flashing green LED turns steady. If control input **A1-Y1/B1** recloses before the time delay is complete, the time delay is reset and the output relay does not change state. Timing starts again when control input **A1-Y1/B1** re-opens. If control supply voltage is interrupted, the output relay de-energizes and the time delay is reset.

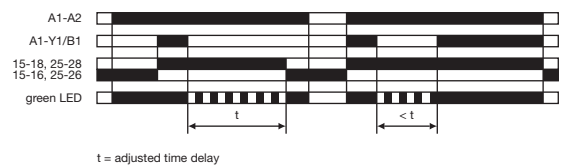

Control and automation technical details

E 234 CT-D time relays for building applications

 **Impulse-ON
(Interval)**
CT-VWD, CT-MFD

This function requires continuous control supply voltage for timing. The output relay energizes immediately when control supply voltage is applied and de-energizes after the set pulse time is complete. The green LED flashes during timing. When the selected pulse time is complete, the flashing green LED turns steady. If control supply voltage is interrupted, the output relay de-energizes and the time delay is reset. Control input **A1-Y1/B1** of the CT-MFD is disabled when this function is selected.

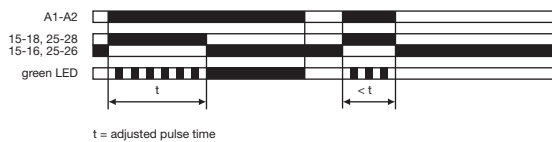

 **Impulse-OFF with auxiliary voltage
(Trailing edge interval)**
CT-MFD

This function requires continuous control supply voltage for timing. If control supply voltage is applied, opening control input **A1-Y1/B1** energizes the output relay immediately and starts timing. The green LED flashes during timing. When the selected pulse time is complete, the output relay de-energizes and the flashing green LED turns steady. Closing control input **A1-Y1/B1**, before the time delay is complete, de-energizes the output relay and resets the time delay. If control supply voltage is interrupted, the output relay de-energizes and the time delay is reset.

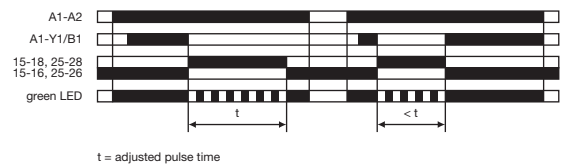

 **Flasher, starting with the ON time
(Recycling equal times, ON first)**
CT-EBD, CT-MFD

Applying control supply voltage starts timing with symmetrical ON & OFF times. The cycle starts with an ON time first. The ON & OFF times are displayed by the flashing green LED, which flashes twice as fast during the OFF time. If control supply voltage is interrupted, the output relay de-energizes and the time delay is reset. Control input **A1-Y1/B1** of the CT-MFD is disabled when this function is selected.

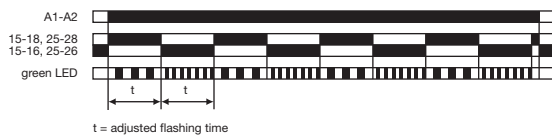

 **Flasher, starting with the OFF time
(Recycling equal times, OFF first)**
CT-MFD

Applying control supply voltage starts timing with symmetrical ON & OFF times. The cycle starts with an OFF time first. The ON & OFF times are displayed by the flashing green LED, which flashes twice as fast during the OFF time. If control supply voltage is interrupted, the output relay de-energizes and the time delay is reset. Control input **A1-Y1/B1** of the CT-MFD is disabled when this function is selected.

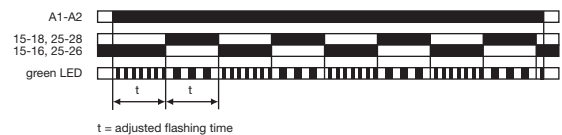

Control and automation technical details

E 234 CT-D time relays for building applications

Pulse former (Single shot) CT-MFD

This function requires continuous control supply voltage for timing. Closing control input **A1-Y1/B1** energizes the output relay immediately and starts timing. Operating the control contact switch **A1-Y1/B1** during the time delay has no effect. The green LED flashes during timing. When the selected ON time is complete, the output relay de-energizes and the flashing green LED turns steady. After the ON time is complete, it can be restarted by closing control input **A1-Y1/B1**. If control supply voltage is interrupted, the output relay de-energizes and the time delay is reset.

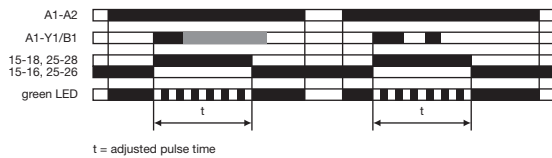

Pulse generator, starting with the ON or OFF time (Recycling unequal times, ON or OFF first) CT-TGD

This function requires continuous control supply voltage for timing. Applying control supply voltage, with open control input **A1-Y1/B1**, starts timing with an ON time first. Applying control supply voltage, with closed control input **A1-Y1/B1**, starts timing with an OFF time first. The ON & OFF times are displayed by the flashing green LED, which flashes twice as fast during the OFF time. The ON & OFF times are independently adjustable. If control supply voltage is interrupted, the output relay de-energizes and the time delay is reset.

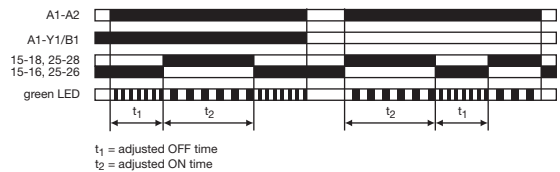

Star-delta change-over (Star-delta starting) CT-SDD, CT-SAD

This function requires continuous control supply voltage for timing. Applying control supply voltage to terminals **A1-A2**, energizes the star contactor connected to terminals **17-18** and begins the set starting time t₁. The green LED flashes during timing. When the starting time is complete, the first output contact de-energizes the star contactor.

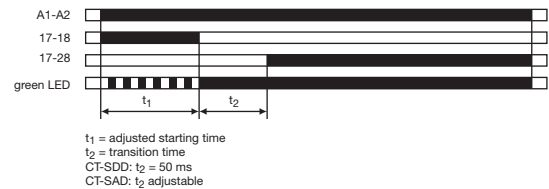

Now, the transition time t₂ starts. When the transition time is complete, the second output contact energizes the delta contactor connected to terminals **17-28**. The delta contactor remains energized as long as control supply voltage is applied to the unit.



Control and automation technical details

E 234 CT-D time relays for building applications – Technical data

Data at $T_a = 25\text{ °C}$ and rated values, unless otherwise indicated

		CT-D with 1 c/o contact	CT-D with 2 c/o contacts	CT-MFD.21
Input circuit - Supply circuit				
Rated control supply voltage U_s		24-240 V AC / 24-48 V DC		12-240 V AC/DC
Rated control supply voltage U_s tolerance		-15...+10 %		
Rated frequency		DC or 50/60 Hz		
Frequency range AC		47-63 Hz		
Typical power consumption		max. 3.5 VA		
Power failure buffering time		min. 20 ms		
Release voltage		> 10 % of the minimum rated control supply voltage U_s		
Current consumption of the control input	24 V DC	3.8 mA (CT-AHD.12) 3.9 mA (CT-MFD.12) 1.0 mA (CT-TGD.12)	0.9 mA (CT-AHD.22, CT-TGD.22)	0.4 mA
	115 V AC	23.9 mA (CT-AHD.12) 23.0 mA (CT-MFD.12) 1.3 mA (CT-TGD.12)	3.2 mA (CT-AHD.22, CT-TGD.22)	0.3 mA
	230 V AC	26.9 mA (CT-AHD.12) 26.0 mA (CT-MFD.12) 1.6 mA (CT-TGD.12)	6.4 mA (CT-AHD.22, CT-TGD.22)	0.7 mA
Input circuit - Control circuit				
Control input, control function	A1-Y1/B1	start timing external		
Kind of triggering		voltage-related triggering		
Resistance to reverse polarity		yes		
Parallel load / polarized		yes / yes		
Maximum cable length to the control inputs		50 m - 100 pF/m		
Minimum control pulse length		20 ms		
Control voltage potential		see rated control supply voltage		
Current consumption of the control input		see data sheet		
Timing circuit				
Time ranges	7 time ranges 0.05 s - 100 h	1.) 0.05-1 s 2.) 0.5-10 s 3.) 5-100 s 4.) 0.5-10 min 5.) 5-100 min 6.) 0.5-10 h 7.) 5-100 h		
	4 time ranges 0.05 s - 10 min (CT-SDD, CT-SAD)	1.) 0.05-1 s 2.) 0.5-10 s 3.) 5-100 s 4.) 0.5-10 min		
Recovery time		< 50 ms		
Accuracy within the rated control supply voltage tolerance		$\Delta t < 0.005\ % / V$		
Accuracy within the temperature range		$\Delta t < 0.06\ % / \text{°C}$		
Repeat accuracy (constant parameters)		$\Delta t < \pm 0.5\ %$		
Setting accuracy of time delay		$\pm 10\%$ of full-scale value		
Star-delta transition time	CT-SDD/ CT-SAD	fixed 50 ms / adjustable: 20 ms, 30 ms, 40 ms, 50 ms, 60 ms, 80 ms or 100 ms		
Star-delta transition time tolerance	CT-SDD / CT-SAD	$\pm 3\ ms$		
Indication of operational states				
Control supply voltage / timing	U: green LED	 : control supply voltage applied  : timing		
Relay energized	R, R1, R2: yellow LED	 : output relay energized		
Operating elements and controls				
Adjustment of the time range		front-face rotary switch, direct reading scales		
Fine adjustment of the time value		front-face potentiometer		
Preselection of the timing function at multifunction devices		front-face rotary switch, direct reading scales		
Adjustment of the transition time	CT-SAC	front-face potentiometer		

Control and automation technical details

E 234 CT-D time relays for building applications – Technical data

		CT-D with 1 c/o contact	CT-D with 2 c/o contacts	CT-MFD.21
Output circuit				
Kind of output	15-16/18	Relay, 1 c/o contact	-	
	15-16/18; 25-26/28	-	Relay, 2 c/o contacts	
	17-18; 17-28		Relay, 2 n/o contacts (CT-SDC, CT-SAC)	
Contact material		AgNi alloy, Cd free		
Rated operational voltage U_e		250 V		
Minimum switching voltage / minimum switching current		12 V / 100 mA		
Maximum switching voltage / maximum switching current		250 V AC / 6 A	250 V AC / 5 A	
Rated operational current I_e	AC-12 (resistive) at 230 V	6 A	5 A	
	AC-15 (inductive) at 230 V	3 A	3 A	n/o: 3 A n/c: 0.75 A
	DC-12 (resistive) at 24 V	6 A	5 A	
	DC-13 (inductive) at 24 V	2 A	2 A	1 A
AC rating (UL 508)	utilization category (Control Circuit Rating Code)	B 300		n/o: B 300 n/c: C 300
	max. rated operational voltage	300 V AC		
	maximum continuous thermal current at B300	5 A		n/o: 5 A
	maximum continuous thermal current at C300	-		n/c: 2.5 A
	max. making/breaking apparent power at B300	3600 VA / 360 VA		n/o: 3600/360 VA
	max. making/breaking apparent power at C300	-		n/c: 1800/180 VA
Mechanical lifetime		30 x 10 ⁶ switching cycles		
Electrical lifetime		0.1 x 10 ⁶ switching cycles		
Max. fuse rating to achieve short-circuit protection	n/c contact	6 A fast-acting		
	n/o contact	10 A fast-acting		6 A fast-acting
General data				
Mean time between failures (MTBF)		on request		
Duty time		100%		
Dimensions		see 'Dimensional drawings'		
Mounting		DIN rail (IEC/EN 60715), snap-mounting without any tool		
Mounting position		any		
Minimum distance to other units	horizontal / vertical	no / no		
Material of housing		UL 94 V-2		
Degree of protection	housing / terminals	IP50 / IP20		
Electrical connection				
Connecting capacity	fine-stranded with(out) wire and ferrule	2 x 0.5-1.5 mm ² (2 x 20-16 AWG)		
		1 x 0.5-2.5 mm ² (1 x 20-14 AWG)		
	rigid	2 x 0.5-1.5 mm ² (2 x 20-16 AWG)		
		1 x 0.5-4 mm ² (1 x 20-12 AWG)		
Stripping length		7 mm (0.28 in)		
Tightening torque		0.5-0.8 Nm (4.43-7.08 lb.in)		
Environmental data				
Ambient temperature range	operation / storage	-20 ... +60 °C / -40 ... +85 °C		
Climatic class	IEC/EN 60721-3-3	3k22		
Relative humidity range		25-85%		
Vibration, sinusoidal	IEC/EN 60068-2-6	20 m/s ² ; 10 cycles, 10...150...10 Hz		
Shock (half-sine)	IEC/EN 60068-2-27	150 m/s ² , 11 ms		

Control and automation technical details

E 234 CT-D time relays for building applications – Technical data

		CT-D with 1 c/o contact	CT-D with 2 c/o contacts	CT-MFC.21
Isolation data				
Rated insulation voltage U_i	input circuit / output circuit	300 V		
	output circuit 1 / output circuit 2	not available	300 V	300 V
Rated impulse withstand voltage U_{imp}	between all isolated circuits	4 kV; 1.2/50 μ s		
Power-frequency withstand voltage test(test voltage)	between all isolated circuits	2.5 kV; 50 Hz; 60 s		
Basic insulation (IEC/EN 60664-1)	input circuit / output circuit	300 V		
Protective separation (IEC/EN 60664-1)	input circuit / output circuit	250 V at pollution degree 2 / overvoltage category II		
Pollution degree (IEC/EN 60664-1)		3		
Overvoltage category (IEC/EN 60664-1)		III		
Standards / Directives				
Standards		IEC/EN 61812-1		
Low Voltage Directive		2014/35/EU		
EMC Directive		2014/30/EU		
RoHS Directive		2011/65/EU		
Electromagnetic compatibility				
Interference immunity to		IEC/EN 61000-6-2, IEC/EN 61000-6-1		
electrostatic discharge	IEC/EN 61000-4-2	Level 3 (6 kV / 8 kV)		
radiated, radio-frequency, electromagnetic field	IEC/EN 61000-4-3	Level 3 (10 V / m)		
electrical fast transient / burst	IEC/EN 61000-4-4	Level 3 (2 kV / 5 kHz)		
surge	IEC/EN 61000-4-5	Level 4 (2 kV L-L)		
conducted disturbances, induced by radio-frequency fields	IEC/EN 61000-4-6	Level 3 (10 V)		
Interference emission		IEC/EN 61000-6-3, IEC/EN 61000-6-4		
high-frequency radiated	IEC/CISPR 22, EN 55022	Class B		
high-frequency conducted	IEC/CISPR 22, EN 55022	Class B		

Control and automation technical details

E 234 CT-D time relays for building applications – Technical diagrams

Example of application - Star-delta changeover

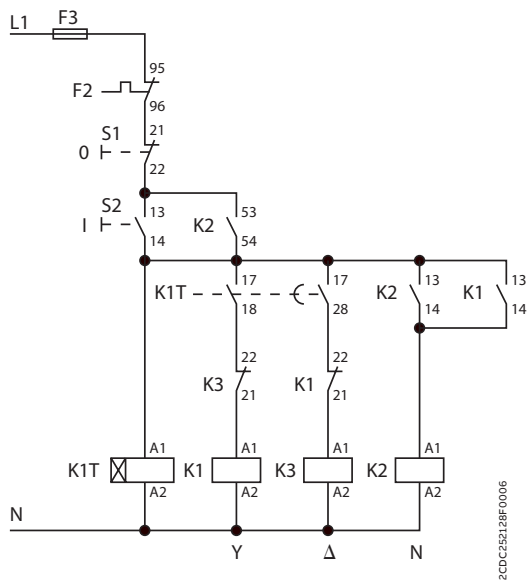

Control circuit diagram

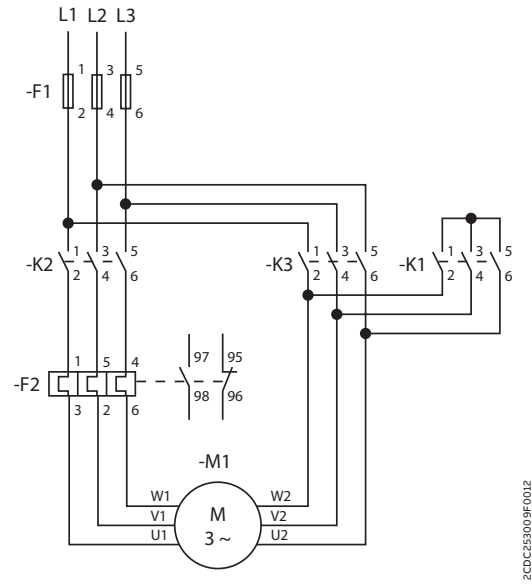

Power circuit diagram

Control and automation technical details

E 234 CT-D time relays for building applications – Technical diagrams

Connection diagrams

CT-MFD.21

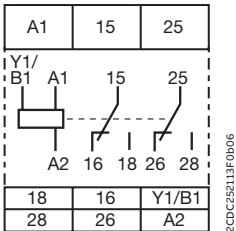

2CDC252119F0b06

A1-A2	Supply: 12-240 V AC/DC
A1-Y1/B1	Control input
15-16/18	1st c/o contact
25-26/28	2nd c/o contact

CT-MFD.12

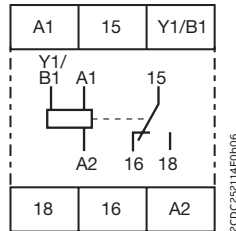

2CDC252114F0b06

A1-A2	Supply: 24-48 V DC or 24-240 V AC
A1-Y1/B1	Control input
15-16/18	1st c/o contact

CT-ERD.22

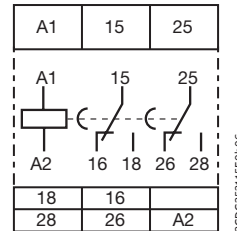

2CDC252119F0b06

A1-A2	Supply: 24-48 V DC or 24-240 V AC
15-16/18	1st c/o contact
25-26/28	2nd c/o contact

CT-ERD.12

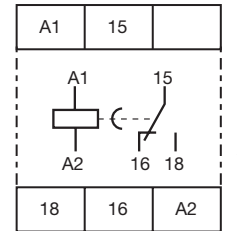

2CDC252177F0b05

A1-A2	Supply: 24-48 V DC or 24-240 V AC
15-16/18	1st c/o contact

CT-AHD.22

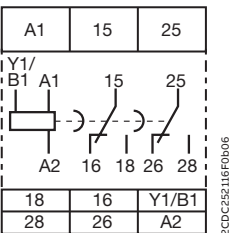

2CDC252116F0b06

A1-A2	Supply: 24-48 V DC or 24- 240 V AC
A1-Y1/B1	Control input
15-16/18	1st c/o contact
25-26/28	2nd c/o contact

CT-AHD.12

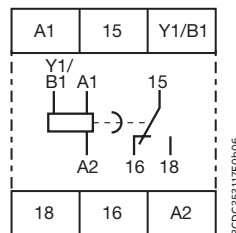

2CDC252117F0b06

A1-A2	Supply: 24-48 V DC or 24- 240 V AC
A1-Y1/B1	Control input
15-16/18	1st c/o contact

CT-VWD.12

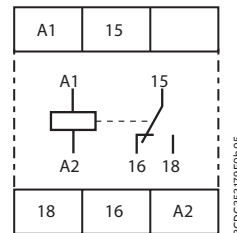

2CDC252179F0b05

A1-A2	Supply: 24-48 V DC or 24- 240 V AC
15-16/18	1st c/o contact

CT-EBD.12

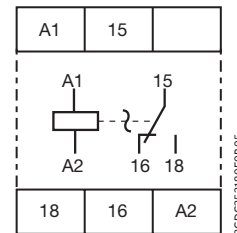

2CDC252180F0b05

A1-A2	Supply: 24-48 V DC or 24-240 V AC
15-16/18	1st c/o contact

CT-TGD.22

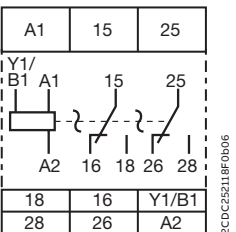

2CDC252119F0b06

A1-A2	Supply: 24-48 V DC or 24-240 V AC
A1-Y1/B1	Control input
15-16/18	1st c/o contact
25-26/28	2nd c/o contact

CT-TGD.12

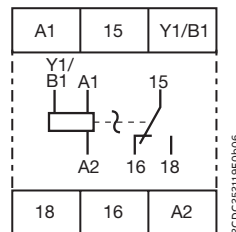

2CDC252119F0b06

A1-A2	Supply: 24-48 V DC or 24- 240 V AC
A1-Y1/B1	Control input
15-16/18	1st c/o contact

CT-SDD.22

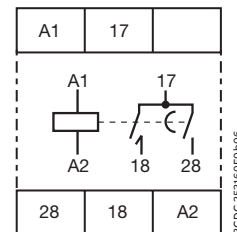

2CDC252160F0b06

A1-A2	Supply: 24-48 V DC or 24-240 V AC
17-18	1st n/o contact (star contactor)
17-28	2nd n/o contact (delta contactor)

CT-SAD.22

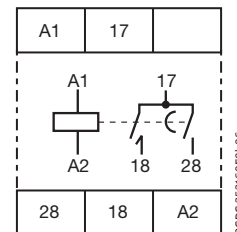

2CDC252160F0b06

A1-A2	Supply: 24-48 V DC or 24-240 V AC
17-18	1st n/o contact (star contactor)
17-28	2nd n/o contact (delta contactor)

Control and automation technical details

E 234 CT-D time relays for building applications – Technical diagrams

Load limit curves

AC load (resistive)

CT-D.1x

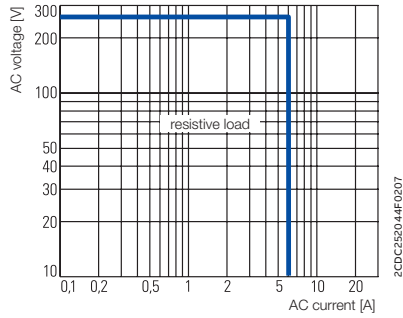

DC load (resistive)

CT-D.1x

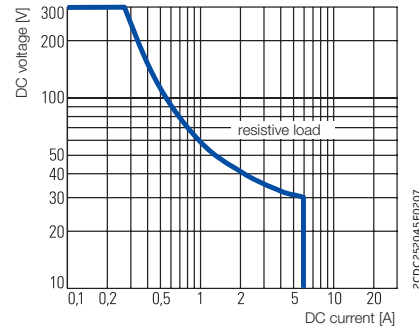

Derating factor F for inductive AC load

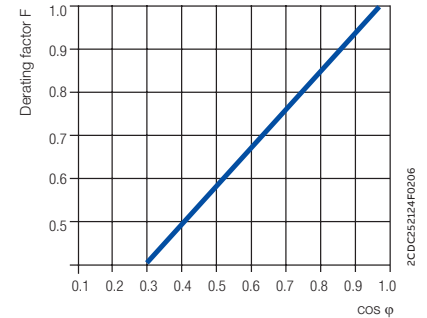

CT-D.2x

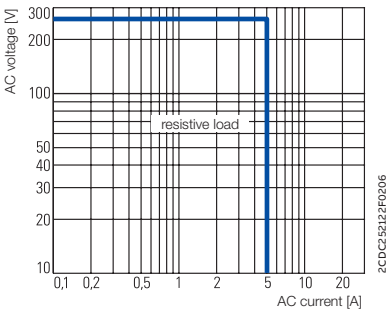

CT-D.2x

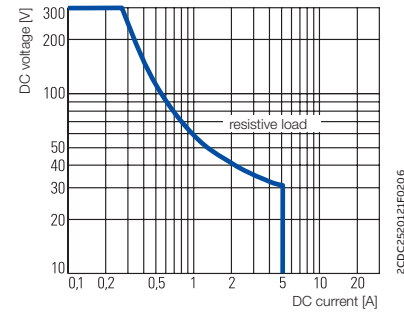

Contact lifetime

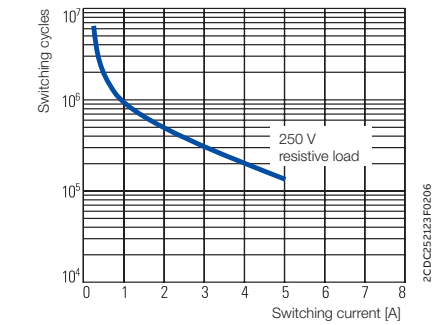

Wiring notes for devices with control input

A parallel load to the control input is possible

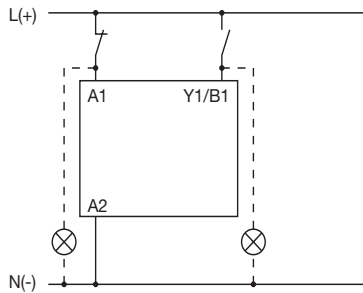

Dimensional drawings

CT-D devices with 1 c/o contact or 2 n/o contacts

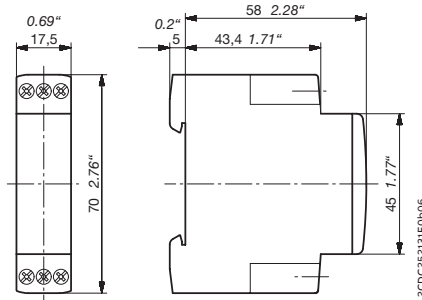

CT-D devices with 2 c/o contacts

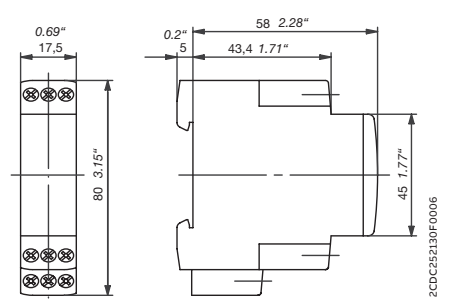

Dimensions in mm, inches

Control and automation technical details

TL Line twilight switches



Main features of DIN rail version - TL1

DIN-Rail version

- 2 indication leds: one for contact status and one for threshold
- Adjustable switching delay
- Preset with 10 LUX from factory
- Brightness range from 2 to 200 lux
- Screw-less version
- 1 module width



TL1 operating principle

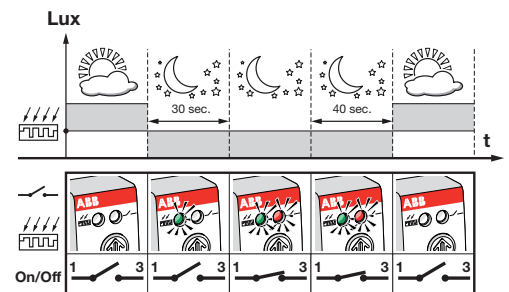
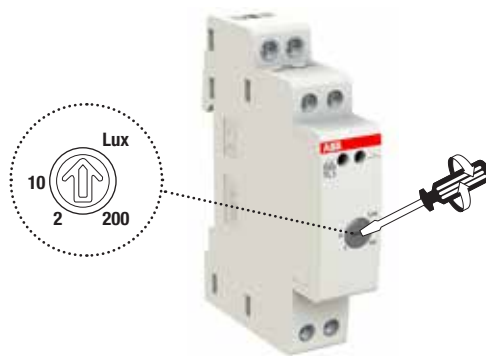

Main features of pole version - TL1 Pole

- Innovative design for direct installation on a pole/wall
- Quick and easy to install, thanks to the simple wiring and ease of adjustment
- Laser etched connection diagram on the back of the product
- Integrated brightness sensor preset at 10 LUX from factory
- Adjustable threshold value from 2 to 200 LUX
- Switching delay of 25 sec. $\pm 10\%$ for ON and 35 sec. $\pm 10\%$ for OFF
- Unlosable screw terminals
- Protection degree IP54

TL1 Pole operating principle

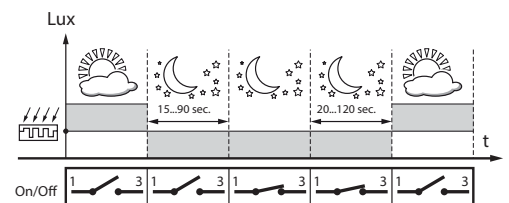
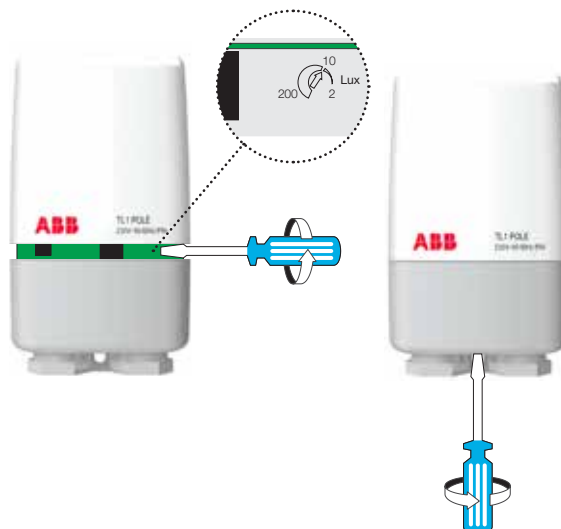

Control and automation technical details

TL Line twilight switches

TL Line with DIN rail mounting – TL1

Operating principle

The diagram shows an example of the installation of the TL1 twilight switch in the lighting system of a commercial building. When the external light falls below a certain level (e.g. during the evening when the shop is closed), the device switches on the window lights and the shop sign. The lights can be switched off late evening to reduce power consumption thanks to the AD1NO-15m switch timer.

Application environments

The installation of the TL1 twilight switch with an AG Timer is particularly useful in settings and situations where energy saving is a prime concern (shops, office corridors and public passageways, car parks, parks, etc.).

Example of installation

As shown in the diagrams, one of the possible applications is the installation of a TL1 twilight switch in the lighting system of a commercial building.

When the external light falls below a certain level (e.g. when the shop is closed), the twilight switch switches on the window lights and the sign. The lights can be switched off late evening to reduce power consumption thanks to the AD1NO-15m switch timer which keeps the circuit open until the next morning. When the external light returns to above the threshold value, the twilight switch relay returns to the open position.

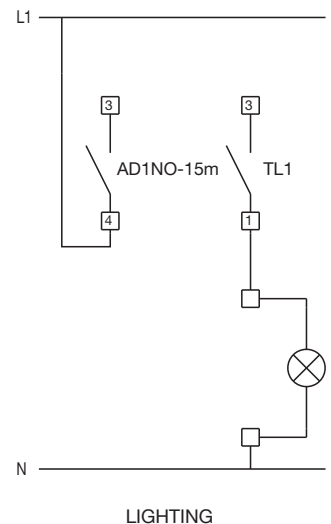
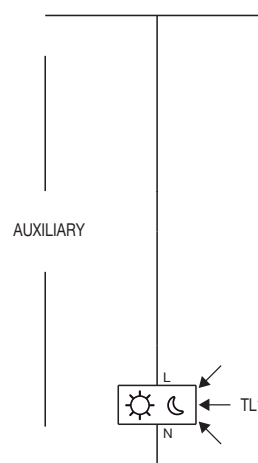
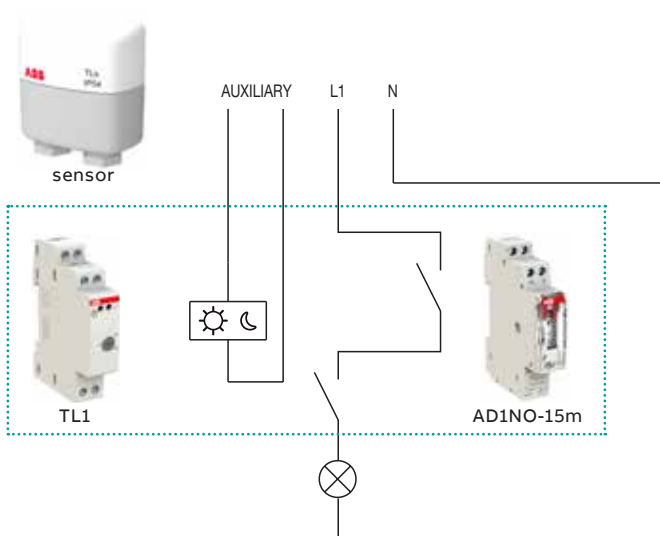

Control and automation technical details

TL Line twilight switches

TL Line with pole/wall mounting – TL1 Pole

Operating principle

The diagram shows an example of the installation of the pole-mounted TL1 Pole twilight switch for motorway lighting systems. When the external light falls below a certain level, 10 lux for example, the device switches on the lights present in tunnels, service areas, near to junctions, etc. The lights are then switched off by the TL1 Pole in the morning when the 10 lux value is exceeded.

Application environments

The installation of the TL1 Pole twilight switch is particularly suitable for controlling public street lighting, thanks to the fact that they can be installed on poles, lamp standards, etc.

Example of installation

As shown in the diagrams, one of the possible applications is the installation of a TL1 Pole twilight switch in the motorway lighting system.

When the external light falls below a certain level (for example at sunset), the pole-mounted twilight switch switches on the lights to provide the correct lighting for the setting. At sunrise, the external brightness exceeds the threshold value and the twilight relay returns to the open position.

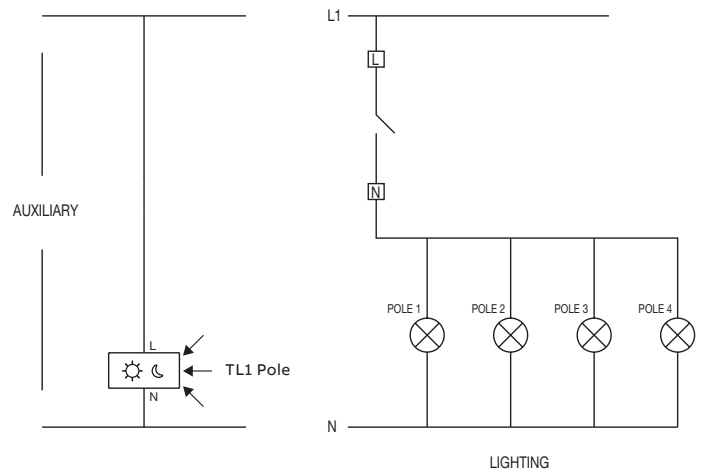
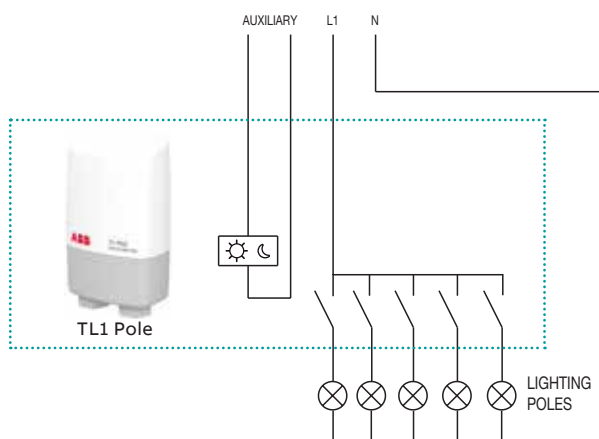

Control and automation technical details

LCR load management relay

Operating principle

LCR load management relays are used in case of exceeding of consumption threshold allowed in the system by switching off in sequence one or two loads, if necessary. At preset intervals and until current consumption is not below the reference level, the switch tries to reset the disconnected loads.

Application environments

The installation of the LCR load management relay is suitable for any environment and situation where it is necessary to control electric energy consumption within consumption limits allowed in the system.

Example of installation

As shown in the diagrams, one of the possible applications is the installation of the LCR load shedding switches in a printing office system, where the conditioning switch-on causes the exceeding of the energy consumption threshold defined with the supplying company by contract. The LCR load shedding switch preserves printing machines operation by switching off one or two primary loads automatically (i.e. night conditioning and lighting), where ON red LEDs indicate temporary OFF. After a preset interval, the switch checks that current consumption values fall within the limits and again tries to reset the previously disconnected loads.

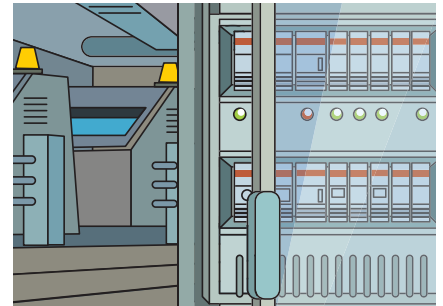
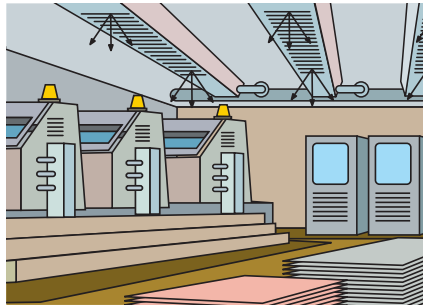
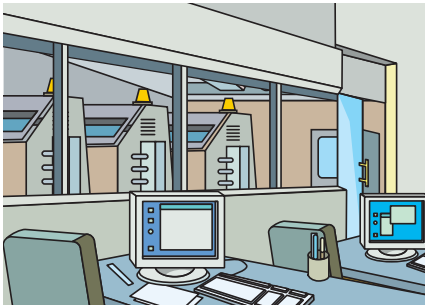

Control and automation technical details

LCR load management relay

Description

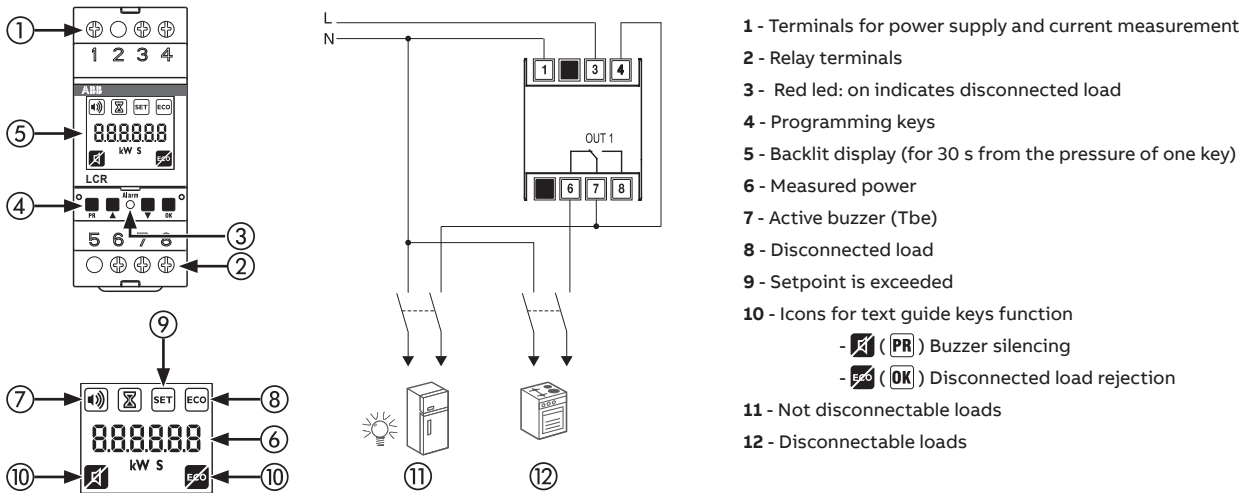

Connection via normally open contacts NO with $I_c \leq 16$ A and $I_a + I_b + I_c \leq 32$ A

Connection via normally closed contacts NC with $I_c \leq 16$ A and $I_a + I_b + I_c \leq 32$ A

