

---

# Sky Niessen

Touch your imagination







# Sky Niessen

## One range range, two personalities

We present the Sky Niessen switch range with two unique and innovative designs. A collection of light switches created so that your spaces take on a new dimension. It is a range of switches that evolved in the shapes and materials used. An object of desire capable of guaranteeing the quality that only Niessen can offer you. Feel special everyday, feel that you have the sky in your hands with the Sky Niessen switches.

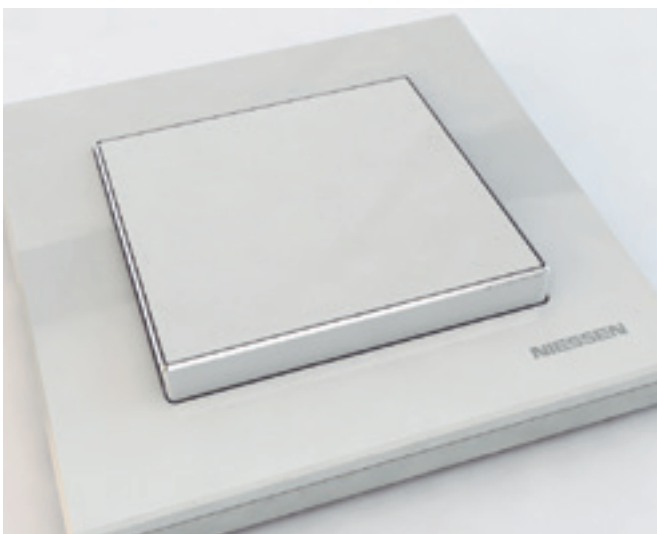

### **Sky Niessen - Elegance on every side**

Linear, balanced, slim... With the Sky Niessen switches you can give each one of your spaces a modern touch. Details count and with Sky Niessen your home will be full of them.



### **Skymoon - A distinctive touch**

With the Skymoon line you will achieve that distinctive touch that makes a room a unique space. Its avant-garde design will mean that all eyes will be drawn to the most attractive item in your home or business.



---

# Sky Niessen







---

# Sky Niessen

## **Slim, balanced, perfect.**

At just 8.5 mm thick, Sky Niessen barely protrudes from the wall. Thanks to the use of subtle components, with Sky Niessen you will achieve a visual perception of perfection in the decoration of any room.





**Maximum  
slimness  
8.5 mm**



**Chrome  
plated trim**

**High-quality  
and durable  
finishes**

**Display**  
Lighting in  
white

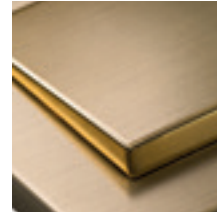

**Gold plated  
trim.** Antique  
gold finish

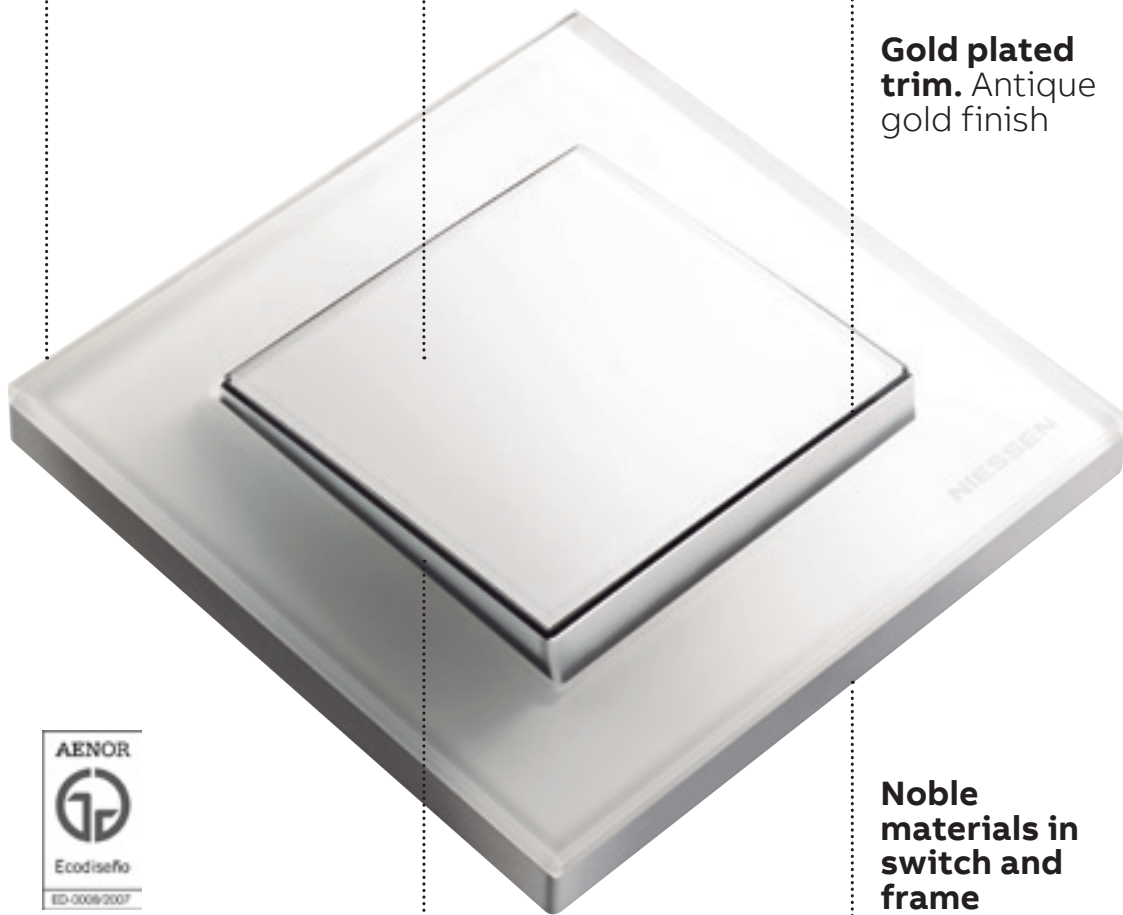

**Eco-design**

The Sky Niessen switch range has been designed following the Product Design and Development Environmental Management regulations: Eco-design.

**Noble  
materials in  
switch and  
frame**

**Minimum gap  
between switch  
and frame**



---

# Sky Niessen

## **Renew your spaces.**

With Sky Niessen you can give your spaces a new air, as it perfectly adapts to other installations done with Niessen. The use of Niessen luxury mechanism facilitates the installation and renovation of each room.

## **Integration and perfection in all aspects.**

With a protrusion of just 8.5 mm above the wall surface, Sky Niessen becomes the series with the most functionality in the least volume. The gap between the switch and the frame is minimised and decorated with chrome details. In addition, its minimalistic design is ideal for combining it with contemporary architecture.

## **A series designed for you.**

Sky Niessen is a collection of switches that responds to the demands of consumers. It is a switch range created to last over time, both thanks to the quality and variety of its finishes, and to its design.





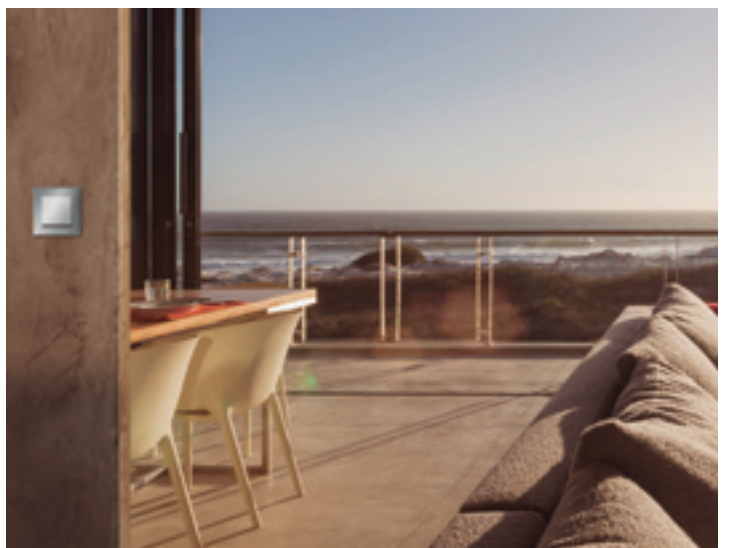
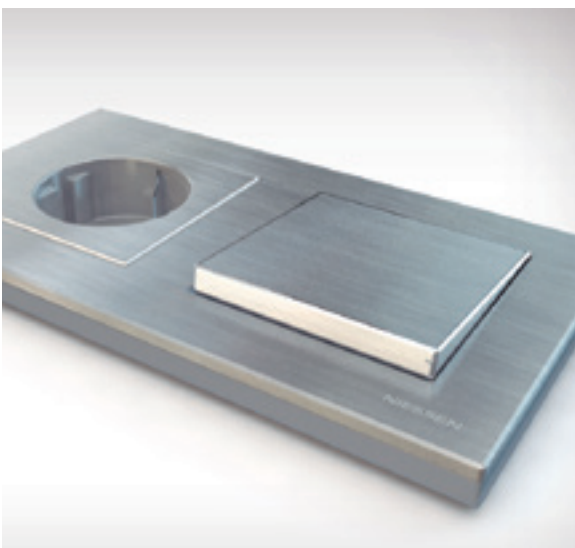







---

# Skymoon



---

# Skymoon

## The finest and most exclusive by Niessen

Skymoon offers minimum protrusion from the wall with a standard installation. Its 6 mm thickness makes it one of the market's thinnest lines. With Skymoon you will have a jewel to decorate the most exclusive environments.



## Maximum slimness 6 mm



**Machined metal switch**  
Also the covers of the functions



**Display**  
Lighting in white

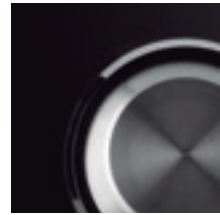

**Chromed outlet cover**  
Available in stainless steel and black finishes



**Perfect integration between switch and frame.**  
Acting as a single assembly

**100% noble materials**  
Available in stainless steel and glass finishes



**Eco-design**

The Sky Niessen switch range has been designed following the Product Design and Development Environmental Management regulations: Eco-design.





---

# Skymoon

## **Unique and exclusive design.**

Skymoon is the ultimate expression of design, with unique class and subtlety. Its round shapes and combination of materials mean that this line is ideal to refine the most luxurious spaces.

## **The ultimate expression in avant-garde and innovation**

Skymoon is an evolution in the market of switch series. Its unique and innovative design presents technical solutions never seen before, which makes Skymoon the focus of everyone's attention.

## **Designed with up to the smallest detail in mind.**

Noble materials, machined metal switches, 6 mm protrusion from the wall... In Skymoon all the details are designed to satisfy the desires of the most demanding customers.

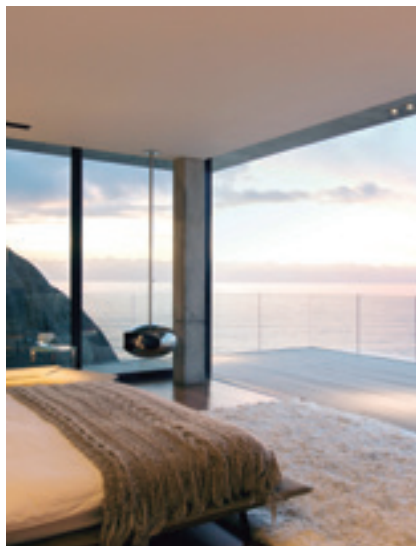

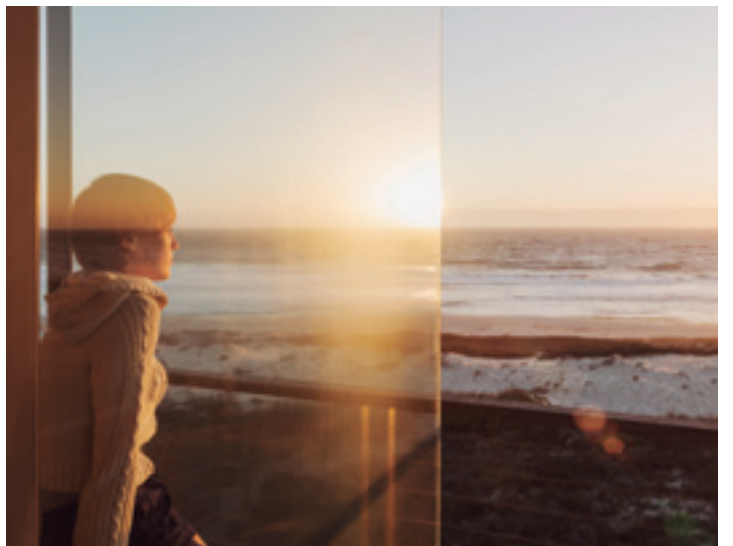

---

## Sky Niessen Finishes



**Soft White**



**Soft Black**



**Silver**



**White Glass**

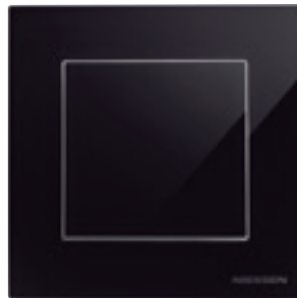

**Black Glass**



**Stainless Steel**



**Antique Gold**



**Ash**



**Natural Wenge**



—  
**Skymoon**  
Finishes



**Stainless Steel**



**Black Glass**



**White Glass**

# Best example of quality, reliability and ease of installation

## Niessen luxury insert

Niessen is proud to have offered the market a concept of inserts for its luxury series for 40 years. This long life of the luxury insert can only be based on the trust of all those who install and use it. And as could not be otherwise, trust must be earned from quality, reliability, safety, ease-of-installation and setting trends at all times:

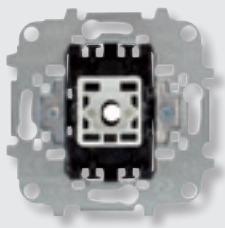

### Tilting insert.

In 1972 the 6100 series switches began to include automatic connection. Today these inserts are still one of the best rated by installers, for their safety by guaranteeing IP20 protection without covers and convenience by enabling automatic connection cables, both flexible and rigid, at the back.

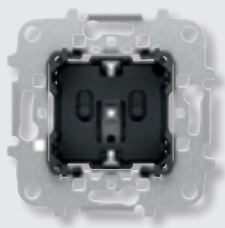

### Schuko socket with screw connection.

The company is currently one of the few manufacturers of recessed series that enable the installer to screw in all terminals from above, in the most visible and comfortable position for the installer. Similarly, all cable inlets are located at the back and not on the sides, firstly to facilitate the connection, even if the cable does not protrude from the box, and secondly to avoid tight turning radiuses with the side of the boxes. IP20 protection guaranteed even in the absence of a cover because child protection is installed in the insert.

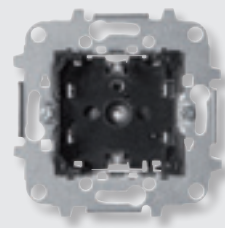

### Schuko socket with automatic connection.

A tried and tested connection system. The pusher is 11.5 mm wide, with a help system on the pusher and additional safety distance between terminals. Similarly, all cable inlets are located at the back and not on the sides, firstly to facilitate the connection, even if the cable does not protrude from the box, and secondly to avoid tight turning radiuses with the side of the boxes. IP20 protection guaranteed even in the absence of a cover because child protection is installed in the insert.

## **Sky Niessen is installed with the same inserts used in Olas, Arco and Tacto.**

Despite its history, the Niessen luxury insert has continued to evolve and will continue to do so. It is our commitment to uphold the values of an insert with such an extensive track record and make sure it is updated in line with the technology, materials and habits always demanded. With the launch of Sky Niessen, as well as adding new features that integrate our latest releases for home automation, new features have also been incorporated into Niessen inserts:

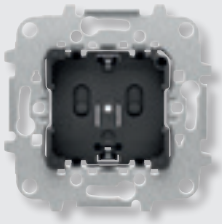

### **Schuko with pilot control.**

Safety and information are two of Niessen's primary values today. Niessen has wanted to continue providing its Schuko inserts as those that are currently most-demanded by users. In this case, Sky Niessen offers the possibility of installing Schuko sockets with a control pilot. Through the LEDs fitted on the new sockets with control pilot the presence of voltage in the Schuko can be seen at all times, providing information to the user and a higher level of safety.



### **Night guide light for new low-consumption loads.**

The use of low-consumption lighting sources from multiple origins are becoming more common in electrical installations in homes, offices and shops. Unfortunately they are not all prepared to work with the night guide lights that have been available on the market to date. In order to facilitate the work of its customers, along with Sky Niessen, Niessen presents a new LED night guide light that eliminates the flicker problems caused by some sources of low-energy lights working together with night guide pilots.

In addition to technological innovation, accompanying the evolution in the design of Sky Niessen, the new light that incorporates Niessen mechanisms emits a white light in line with new trends in lighting.



## Sky Niessen

### Table of article numbers

#### Inserts

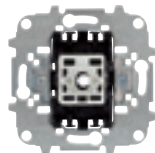

#### Rockers and cover plates

Soft White (BL)



Silver (PL)



Soft Black (NS)



Stainless Steel (AI)



White Glass (CB)



Black Glass (CN)



Antique Gold (OE)



#### Colours XX

#### Rockers and cover plates

BL Soft White

PL Silver

NS Soft Black

AI Stainless Steel

CB White Glass

CN Black Glass

OE Antique Gold

#### Frames

BL Soft white

PL Silver

NS Soft Black

AI Stainless Steel

OE Antique Gold

FR Ash

WN Natural Wenge

CB White Glass

CN Black Glass

Insert description	Article No.	Pack (unit)	Description	Article No.	Color	Pack (unit)
<b>1-way switches</b>			<b>Rockers for switches and push-buttons</b>			
Switch 1-gang, 1-way, single pole	8101	10	Rocker for switch	8501	XX	20/10
<b>2-way switches</b>			Rocker with On/Off symbol			
Switch 1-gang, 2-way, single pole	8102	10	Rocker for switch with lens	8501.2	XX	5
Switch 1-gang, 2-way, single pole 16A	8102.1	10	Rocker with lens & On/Off symbol	8501.3	XX	10/5
<b>Intermediate switches</b>			Rocker with lens & On/Off symbol			
Switch 1-gang, intermediate, single pole	8110	10				
<b>Double pole switches</b>						
Switch 1-gang, 1-way, double pole 16A	8101.1	10				
Switch 1-gang, 1-way, double pole	8101.2	10				
<b>Switches with indicator lamp</b>			<b>Rockers for switches and push-buttons</b>			
Switch 1-gang, 1-way, single pole	8101.5	10	Rocker for switch with lens	8501.3	XX	10/5
Switch 1-gang, 2-way, single pole	8102.5	10	Rocker with lens & On/Off symbol	8501.4	XX	5
<b>Push-buttons</b>			<b>Rockers with symbols</b>			
Push-button 1-gang, single pole, NO	8104	10	Rocker with bell symbol	8504	XX	10
Push-button 1-gang, SP, NO w/ locator lamp	8104.5	10	Rocker with light symbol	8504.2	XX	10
Push-button 1-gang, single pole, NC	8104.9	5	Rocker with bell symbol & lens	8504.3	XX	5
			Rocker with light symbol & lens			
			8504.4			
				XX		
				5		
<b>Indicator / locator LED lamp</b>						
Indicator/locator LED lamp 230Vac			6192			
			BL			
			10			
<b>2-gang switches &amp; push-buttons</b>			<b>Cover plates</b>			
Switch 2-gangs, 1-way, single pole	8111	10	Rocker for switch/ push-button, 2-gangs	8511	XX	20/10
Switch 2-gangs, 2-way, single pole	8122	10				
Push-button 2-gangs, single pole, NO	8144.2	10	Rocker for switch + push-button, 2-gangs	8542	XX	5
Switch 2-way + push-button 1-way NO, SP	8142	10				
<b>Card switches</b>			<b>Cover plate</b>			
Card switch 1-gang, 1-way, double pole	8114	10	Cover plate for card switch with lens	8514	XX	10
Card switch 1-gang, 1-way, double pole 16A	8114.1	10				
Card switch 1-gang, 2-way, double pole	8114.2	10				
Card switch 1-gang, 1-way, SP w/ time delay	8114.5	1				
<b>Key switches</b>			<b>Cover plates</b>			
Key switch 1-way, 2 positions, single pole	8153	1	Cover plate for 2 position key switch	8553	XX	1
Key push button 1-way, 2 positions, SP	8153.2	1				
Key switch 2-way, 3 positions, single pole	8153.1	1	Cover plate for 3 position key switch	8553.1	XX	1
<b>Blind controls</b>			<b>Cover plates</b>			
Push-button blind control 2-gangs	8144	10	Rocker for blind switch/ push-button	8544	XX	10/5
Switch blind control 2-gangs	8144.1	10				
Electronic blind control 1-gang	8130.3	1	Electronic rocker for blind control	8530	XX	1
<b>Pullcord switches</b>			<b>Cover plates</b>			
Pullcord switch 1-gang, 1-way, single pole	8148	5	Cover for pull cord switch	8507	XX	10
<b>Schuko socket outlets</b>			<b>Cover plates</b>			
Schuko socket outlet	8188	10	Cover plate for Schuko socket outlet	8588	XX	20/10/5
Schuko socket outlet	8188.5	10	Cover plate for Schuko socket outlet w/ lid	8588.1	XX	10/5
Schuko socket outlet screwless connection	8188.6	10				
Schuko socket outlet with indicator lamp	8188.8	5	Cover plate for Schuko socket outlet w/ lens	8588.8	XX	10
Schuko socket outlet for plain covers	8188.9	10	Flat cover plate for Schuko socket outlet	8588.9	XX	20/10
<b>French / earth-pin socket outlets</b>			<b>Cover plates</b>			
French/Earth-pin socket outlet	8187	10	Cover plate for French socket outlet	8587	XX	20
French/Earth-pin socket outlet for plain covers	8187.9	10	Flat cover plate for French socket outlet	8587.9	XX	10
<b>Push-buttons</b>			<b>Cover plates</b>			
Universal socket outlet	8139	10	Cover plate for Euroamerican socket outlet	8538	XX	10
			Cover plate for Universal socket outlet			
			8539			
			XX			
			10			
<b>British standard socket outlet - 2M</b>			Cover plate for British socket outlet			
			8537			
			XX			
			10			
<b>USB chargers</b>			<b>Cover plates</b>			
USB charger 1.500mA, 2 outlets	8185	1	Cover plate for USB charger 1.5 A	8585	XX	5
USB charger 2.000 mA, 1 outlet	8185.2	1	Cover plate for USB charger 2A	8585.2	XX	1
USB charger 2x 2.000mA, 2 outlets	8185.3	1	Cover plate for USB charger 2x 2A	8585.3	XX	1
<b>Protection devices</b>			<b>Cover plate</b>			
Circuit breaker 6A & RCD 10mA	8134.1	1	Cover plate for circuit breaker & RCD	8534	XX	1
Circuit breaker 10A & RCD 10mA	8134.2	1				
Circuit breaker 16A & RCD 10mA	8134.3	1				
<b>TV outlets</b>			<b>Cover plates</b>			
TV / R terminal outlet	8150	10	Cover plate for TV/R outlet	8550	XX	20
TV / R final outlet - CATV outlet	8150.3	10				
TV / R loop-through outlet	8150.7	10				
TV-R/SAT terminal outlet	8151.3	10	Cover plate for TV-R/SAT outlet	8550.1	XX	20
TV-R/SAT final outlet	8151.7	10				
TV-R/SAT loop-through outlet	8151.8	10				
<b>Telephone &amp; data outlets</b>			<b>Cover plates</b>			
Telephone outlet RJ12	8117	10	Cover plate for telephone/ data outlets	8517	XX	10
Data outlet RJ45 Cat.5e UTP	8118	10				
Telephone outlet RJ12	2017.2	10	Cover plate for data outlet 1-gang	8518.1	XX	10
Telephone outlet RJ45 Cat.3	2017.3	10				
Data outlet RJ45 Cat.5e UTP	2018.5	10	Cover plate for data outlet 2-gangs	8518.2	XX	10
Data outlet RJ45 Cat.6 UTP	2018.6	10				
Data outlet RJ45 Cat.6A STP	2018.7	10				
Housing for data outlets - Keystone type	2018	10				
Housing for data outlets - Systimax type	2018.8	10				
<b>VDI connectors</b>			<b>Cover plates</b>			
Mini-Jack connection unit	8155.4	1	Cover plate 1-gang VDI connection unit	8555	XX	1
HDMI connection unit	8155.6	1				
HDMI female-female connection unit	8155.7	1				
USB connection unit	8155.8	1				
USB female-female connection unit	8155.9	1				
HDMI wired + USB connection unit	8155.68	1	Cover plate 2-gangs VDI connection unit	8555.1	XX	1
HDMI female-female + USB connection unit	8155.78	1				
Double USB connection unit	8155.88	1				
2x RCA connection unit	8155.2	1	Cover plate 2RCA connection unit	8555.2	XX	1
3x RCA connection unit	8155.3	1	Cover plate 3RCA connection unit	8555.3	XX	1
VGA connection unit	8155.5	1	Cover plate VGA connection unit	8555.5	XX	1
VGA + 2RCA connection unit	8155.52	1	Cover plate VGA + 2RCA connection unit	8555.6	XX	1
VGA + mini-Jack connection unit	8155.54	1	Cover plate VGA + mini-jack connection unit	8555.4	XX	1

Insert description	Article No.	Pack (unit)	Description	Article No.	Color	Pack (unit)
<b>Light controls - Rotatory dimmers</b>			<b>Cover plate</b>			
Rotatory dimmer, RL, 20-500 W	8160	1	Cover plate with rotatory knob for dimmer	8560.2	XX	5
Rotatory dimmer, LED, 2-100 W	8160.2	1				
Rotatory dimmer, RL, 200-1000 W	8160.3	1				
Rotatory dimmer, RL, 60-400 W	8160.5	1				
Rotatory dimmer, RC, 40-420 W	8160.7	1				
Rotatory dimmer, RLC, 60-420 W	8160.8	1				
Rotatory dimmer, 1-10Vdc	8160.9	1				
Rotatory dimmer remote control	8161.8	1				
<b>Light controls - Push dimmers</b>						
Rotatory dimmer remote control	8130	1	Electronic rocker for dimmer switch	8530	XX	1
Universal push dimmer 40-450W	8160.1	1	Cover plate for universal push dimmer	8560.1	XX	5
<b>Light controls - DALI controllers</b>			<b>Cover plate</b>			
Rotatory DALI dimmer	8161.4	1	Cover plate with rotatory knob for dimmer	8560.2	XX	5
Rotatory DALI dimmer with power supply	8161.5	1				
<b>Light controls - Timer switches</b>			<b>Cover plates</b>			
Universal single relay time delayed switch	8130.1	1	Electronic rocker for time delayed switch	8530	XX	1
Universal double relay time delayed switch	8130.2	1	Cover plate for timer switch	8562	XX	1
Time delayed switch with relay	8162	1				
Time delayed switch with triac	8162.1	1				
<b>Light controls - Keypad switches</b>			<b>Cover plate</b>			
Keypad switch with time delay function	8153.5	1	Cover keypad switch BL	8553.5	XX	1
<b>Light controls - Motion sensors</b>			<b>Cover plate</b>			
MOS-Fet switch for motion sensor	8141.3	1	180° motion sensor	8541.1	XX	1
Relay switch for motion sensor	8141.4	1				
<b>Light controls - Programmable switches</b>			<b>Cover plate</b>			
Relay switch	8161	1	Cover plate for timer control element	8565.3	XX	1
Relay switch for blinds	8161.2	1				
Timer control element	8165.31	1				
<b>Light controls - Remote control</b>			<b>Cover plate</b>			
Wireless switch transmitter - 1 channel	8531.1	1				
Wireless switch transmitter - 2 channel	8531.2	1				
Wireless switch actuator	8130.4	1				
Wireless dimming actuator	8130.5	1				
Wireless blind actuator	8130.7	1				
Wireless DIN-rail actuator	8130.6	1				
4 position rotary switch	8154	10				
<b>Temperature controls - RTC</b>			<b>Cover plates</b>			
Digital room thermostat	8140.5	1	Cover plate for digital thermostat	8540.5	XX	5/1
Rotatory room thermostat with floor sensor	8140.9	1	Cover plate with rotatory knob for RTC	8540.9	XX	5
<b>Signaling and lighting systems</b>			<b>Cover plates</b>			
LED signaling light	8180.1	1	Cover for signaling light: white, red & green Cover for signaling light: "WC" symbol "WC men" symbol "WC women" symbol "WC handic." symbol "No smoking" symbol "No phone" symbol "Silence" symbol "Silence" symbol "No entry" symbol "Elevator" symbol "Exit" symbol "Info point" symbol	8581	XX	5
LED DND/MUR signaling light	8180.2	1		8581.10	XX	5
Beacon LED light	8181.2	1		8581.11	XX	5
				8581.12	XX	5
				8581.13	XX	5
				8581.14	XX	5
				8581.15	XX	5
				8581.16	XX	5
				8581.17	XX	5
				8581.18	XX	5
				8581.19	XX	5
				8581.20	XX	5
				8581.21	XX	5
<b>Buzzer / Door bell</b>			<b>Cover plate</b>			
Buzzer	8119	10	Cover plate for buzzer/door bell	8529	XX	5
Electronic door bell with 4 melodies	8124.2	1				
<b>Blank covers / Cable outlets</b>			<b>Cover plates</b>			
Cable outlet	8107	10	Blank cover plate	8500	XX	10
			Cover plate for cable outlet	8507	XX	10
<b>Surface mounting boxes</b>			<b>Cover plate</b>			
Surface mounting box 1-gang	8591	6				
Surface mounting box 2-gang	8592	5				
Surface mounting box 3-gang	8593	1				
Flush mounting box - Bricks and cement	1099	50				
Flush mounting box - Drywall and partitions	999	25				
Flush mounting box - Drywall and partitions	999.2	10				
<b>Multiroom Bluetooth system</b>						
Multiroom sound module	9368.1	1	Cover plate for radio/remote control modules	8568	XX	1
Remote control for multiroom sound module - 2M	9368.2	1				
<b>FM radio with alarm</b>			<b>Cover plate</b>			
FM-radio and alarm module - 2M	9368	1	Cover plate for radio/remote control modules	8568	XX	1
	9368.7	1				
<b>Auxiliary module</b>			<b>Cover plate</b>			
Auxiliary module - 2M	9368.3	1	Cover plate for I/O + USB + Bluetooth module	8568.3	XX	1
<b>2" loudspeaker for wall</b>			<b>Cover plates</b>			
2" loudspeaker 2 W	9329	1	Cover plate for 2" loudspeaker	8529	XX	5
			Cover plate for 2" loudspeaker	8629	XX	5
			Embellishing grid for 2" loudspeaker	9399.4	XX	5
<b>5" loudspeaker for ceiling</b>			<b>Cover plate</b>			
5" loudspeaker 6 W	9329.1	1	Cover plate for 2" loudspeaker	8529	XX	12
Installation box for 5" loudspeaker	9399	12				
Installation ring for 5" loudspeaker	9399.1	12				
<b>Auxiliary amplifier</b>			<b>Cover plate</b>			
Auxiliary 20W amplifier	9335.1	1				
<b>Potentiometers</b>			<b>Cover plate</b>			
Potentiometer for loudspeakers 3W	8159.3	1	Cover plate with rotatory knob for potentiometer	8559	XX	1
Potentiometer for loudspeakers 5W	8159.5	1				
<b>Connection units</b>			<b>Cover plate</b>			
Speaker connection unit	8157.1	1	Cover plate for speaker connection unit	8557.1	XX	1

**Frames Sky Niessen Soft**

Soft white (BL)



Silver (PL)



Soft Black (NS)

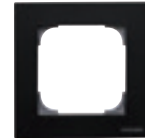

**Sky Niessen Steel**

Stainless Steel (AI)



Antique Gold (OE)



**Sky Niessen Wood**

Ash (FR)



Natural Wenge (WN)



**Sky Niessen Glass**

White Glass (CB)



Black Glass (CN)



Sky Niessen Soft	Article No.	Color	Pack (unit)
1 gang	8571	XX	20
2 gangs	8572	XX	20
3 gangs	8573	XX	10
4 gangs	8574	XX	5
<b>Sky Niessen Wood</b>			
1 gang	8571	XX	1
2 gangs	8572	XX	1
3 gangs	8573	XX	1
4 gangs	8574	XX	1
<b>Sky Niessen Steel</b>			
1 gang	8571	XX	10
2 gangs	8572	XX	10
3 gangs	8573	XX	10
4 gangs	8574	XX	5
<b>Sky Niessen Glass</b>			
1 gang	8571	XX	1
2 gangs	8572	XX	1
3 gangs	8573	XX	1
4 gangs	8574	XX	1

## Sky Niessen

### Table of article numbers

#### Rockers and cover plates

Soft White (BL)



Silver (PL)



Soft Black (NS)



Stainless Steel (Al)



Antique Gold (OE)



White Glass (CB)



Black Glass (CN)



#### Frames Sky Niessen

Soft white (BL)



Silver (PL)



Soft Black (NS)



Stainless Steel (Al)



Antique Gold (OE)



White Glass (CB)



Black Glass (CN)



Ash (FR)



Natural Wenge (WN)



Insert description	Article No.	Pack (unit)	Description	Article No.	Color	Pack (unit)
<b>Sensors free@home</b>			<b>Cover plates</b>			
Sensor unit - 1-gang	SU-F-1.0.1	1	Cover plate - 1-gang sensors	SR-1-85	XX	1
Sensor/Switch actuator - 1/1-gang	SSA-F-1.1.1	1	Cover plate - 1-gang sensors - Switch	SRL-1-85	XX	1
Sensor/Dimmer actuator - 1/1-gang	SDA-F-1.1.1	1	Cover plate - 1-gang sensors - Dimmer	SRD-1-85	XX	1
Sensor/Blind actuator - 1/1-gang	SBA-F-1.1.1	1	Cover plate - 1-gang sensors - Blind	SRB-1-85	XX	1
Sensor unit - 1-gang - Wireless	SU-F-1.0.1-WL	1	Cover plate - 1-gang sensors - Scene	SRS-1-85	XX	1
Sensor/Switch actuator - 1/1-gang - Wireless	SSA-F-1.1.1-WL	1				
Sensor/Dimmer actuator - 1/1-gang - Wireless	SDA-F-1.1.1-WL	1				
Sensor/Blind actuator - 1/1-gang - Wireless	SBA-F-1.1.1-WL	1				
<b>Sensors free@home</b>			<b>Cover plates</b>			
Sensor unit - 2-gang	SU-F-2.0.1	1	Cover plate - 2-gang sensors	SR-2-85	XX	1
Sensor/Switch actuator - 2/1-gang	SSA-F-2.1.1	1	Cover plate - 2-gang sensors - Switch - Left	SRL-2-L-85	XX	1
Sensor/Dimmer actuator - 2/1-gang	SDA-F-2.1.1	1	Cover plate - 2-gang sensors - Switch - Right	SRL-2-R-85	XX	1
Sensor/Blind actuator - 2/1-gang	SBA-F-2.1.1	1	Cover plate - 2-gang sensors - Dimmer - Left	SRD-2-L-85	XX	1
Sensor unit - 2-gang - Wireless	SU-F-2.0.1-WL	1	Cover plate - 2-gang sensors - Dimmer - Right	SRD-2-R-85	XX	1
Sensor/Switch actuator - 2/1-gang - Wireless	SSA-F-2.1.1-WL	1	Cover plate - 2-gang sensors - Blind	SRB-2-85	XX	1
Sensor/Dimmer actuator - 2/1-gang - Wireless	SDA-F-2.1.1-WL	1	Cover plate - 2-gang sensors - Scene - Left	SRS-2-L-85	XX	1
Sensor/Blind actuator - 2/1-gang - Wireless	SBA-F-2.1.1-WL	1	Cover plate - 2-gang sensors - Scene - Right	SRS-2-R-85	XX	1
<b>Sensor &amp; dimmer actuators free@home</b>			<b>Cover plates</b>			
Sensor/Switch actuator - 2/2-gang	SSA-F-2.2.1	1	Cover plate - 2-gang sensors	SR-2-85	XX	1
Sensor/Switch actuator - 2/2-gang - Wireless	SSA-F-2.2.1-WL	1	Cover plate - 2-gang sensors - Switch - Left	SRL-2-L-85	XX	1
			Cover plate - 2-gang sensors - Switch - Right	SRL-2-R-85	XX	1
			Cover plate - 2-gang sensors - Dimmer - Left	SRD-2-L-85	XX	1
			Cover plate - 2-gang sensors - Dimmer - Right	SRD-2-R-85	XX	1
			Cover plate - 2-gang sensors - Blind	SRB-2-85	XX	1
			Cover plate - 2-gang sensors - Scene - Left	SRS-2-L-85	XX	1
			Cover plate - 2-gang sensors - Scene - Right	SRS-2-R-85	XX	1
<b>Room temperature controller free@home</b>			<b>Cover plates</b>			
Room temperature controller	RTC-F-1	1	Cover plate - RTC	CP-RTC-85	XX	1
Room thermostat - Wireless	RTC-F-1-WL	1	Cover plate - fan coil control	CP-RTC-FC-85	XX	1
Room thermostat/actuator - Wireless	RTC-F-2.1.1-WL	1				
<b>Motion sensor &amp; actuators</b>			<b>Cover plate</b>			
free@home 180° motion sensor	MD-F-1.0.PB.1	1	Cover plate - motion sensor	CP-MD-85	XX	1
free@home 180° motion sensor/actuator	MSA-F-1.1.PB.1	1				
<b>Touch displays</b>			<b>Cover plate</b>			
ABB-free@homeTouch 7"	DP7-S-611	1				
ABB-free@homeTouch 7"	DP7-S-625	1				
ABB-free@homeTouch 4.3"	DP4-1-611	1				
ABB-free@homeTouch 4.3"	DP4-1-625	1				
Flush mounting installation box	DP4-F	1				
Temperature sensor	DP4-T-1	1				
<b>System Access Point</b>			<b>Cover plate</b>			
System Access Point - Wireless	SAP-S-2	1				
External antenna - Wireless	SAP-1-WL	1				
<b>Weather station</b>			<b>Cover plate</b>			
Weather station	WS-1	1				
Power supply	PS-M-64.1.1	1				
<b>Binary inputs</b>			<b>Cover plate</b>			
Binary input 2-gang	BI-F-2.0.1	1				
Binary input 4-gang	BI-F-4.0.1	1				
Binary input 4-gang	BI-M-4.0.1	1				
<b>Switch actuators</b>			<b>Cover plate</b>			
Binary input 8-gang / switch actuator 8-gang	SA-M-8.8.1	1				
Switch actuator 4-gang	SA-M-0.4.1	1				
<b>Dimmer actuator</b>			<b>Cover plate</b>			
Dimming actuator 4-gang	DA-M-0.4.2	1				
<b>Blind actuator</b>			<b>Cover plate</b>			
Blind actuator 4-gang	BA-M-0.4.1	1				
<b>Heating &amp; fan coil actuators</b>			<b>Cover plate</b>			
Heating actuator 6-gang	HA-M-0.6.1	1				
Heating actuator 12-gang	HA-M-0.12.1	1				
Fan coil actuator	FCA-M-2.3.1	1				
<b>Push-button coupler</b>			<b>Cover plate</b>			
KNX Push-button coupler - 1/2-gang	6108/01-509	1	Rocker for switch, 1-gang	8501	XX	20
KNX Push-button coupler - 2/4-gang	6108/02-509	1	Rocker for switch/push-button, 2-gangs	8511	XX	20
<b>Sensor KNX</b>			<b>Cover plates</b>			
KNX Push-button coupler - 2-gang with bus coupler	6108/06-500	1	Cover plate - KNX 1-gang sensors	SR-1-85	XX	1
			Cover plate - KNX 1-gang sensors - Switch	SRL-1-85	XX	1
			Cover plate - KNX 1-gang sensors - Dimmer	SRD-1-85	XX	1
			Cover plate - KNX 1-gang sensors - Blind	SRB-1-85	XX	1
			Cover plate - KNX 1-gang sensors - Scene	SRS-1-85	XX	1
KNX Push-button coupler - 4-gang with bus coupler	6108/07-500	1	Cover plate - KNX 2-gang sensors - Switch - Left	SRL-2-L-85	XX	1
			Cover plate - KNX 2-gang sensors - Switch - Right	SRL-2-R-85	XX	1
			Cover plate - KNX 2-gang sensors - Dimmer - Left	SRD-2-L-85	XX	1
			Cover plate - KNX 2-gang sensors - Dimmer - Right	SRD-2-R-85	XX	1
			Cover plate - KNX 2-gang sensors - Blind	SRB-2-85	XX	1
			Cover plate - KNX 2-gang sensors - Scene - Left	SRS-2-L-85	XX	1
			Cover plate - KNX 2-gang sensors - Scene - Right	SRS-2-R-85	XX	1
KNX Room thermostat with display	6108/18-500	1	Cover plate - KNX RTC	CP-RTC-85	XX	1
KNX RTC with 5-gang universal input	6109/18-500	1	Cover plate - KNX fan coil control	CP-RTC-FC-85	XX	1
KNX RTC with CO2/moisture sensor	6109/28-500	1	Cover plate - KNX RTC with CO2/moisture sensor	CP-CO-85	XX	1
KNX 180° motion sensor	6122/98-509	1	Cover plate - KNX motion sensor	CP-MD-85	XX	1



# Sky Niessen series

With Sky Niessen you can offer a higher level of design in your reform projects. Quick and easy, as it perfectly adapts to other installations done with Niessen. The use of Niessen's luxury insert facilitates the installation and renovation of each room.

## Switch composition

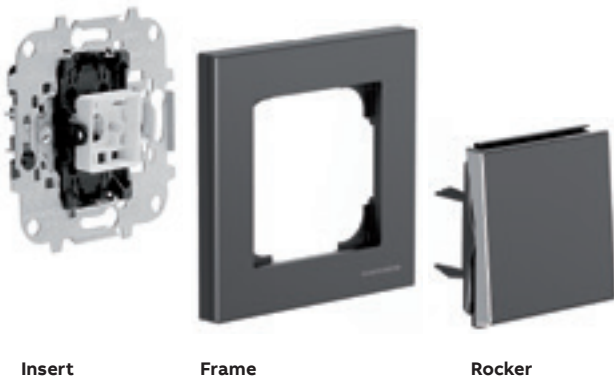

### Characteristics

- 250 V~
- 10 AX / 16 AX
- IP21
- CE Compliance Declaration pursuant to:
  - Low Voltage Directive 2006/95/CE
  - European Directive RoHS 2011/65/EU
  - IEC 60669-1
  - UNE-EN 60669-1
  - UNE 20324-REBT-BT27 - IP21
- AENOR certified product pursuant to:
  - UNE-EN 60669-1
  - UNE-EN 60669-1/A1
  - UNE-EN 60669-1/A2

## Socket composition

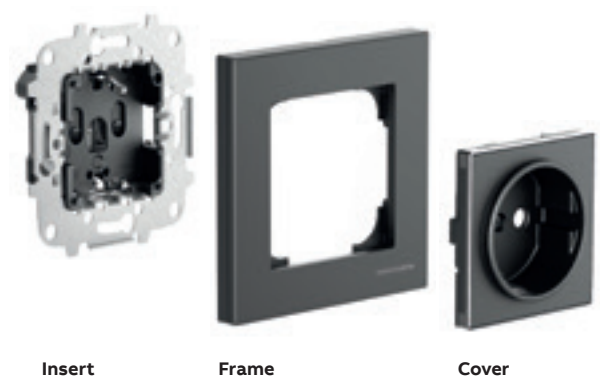

### Characteristics

- 250 V~
- 16 A
- IP21
- Compliant with standards:
  - European Directive RoHS 2011/65/EU
  - IEC 60884-1
  - UNE-EN 20315
  - UNE 20324-REBT-BT27 - IP21
- AENOR certified product pursuant to:
  - UNE 20315-1-1

## Sky Niessen

### 1-way switches

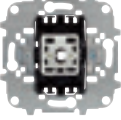
Product	Article-No.	Order-No.	Pack/Qty
	<b>Switch 1-gang, 1-way, single pole</b> Rated voltage: 110 - 250 Vac. Rated current: 10 AX. Screwless terminals. Included: fixing claws. Optional: locator LED lamp 6192 BL (230 Vac). Rocker code: 8501, 8501.2, 8501.3 & 8501.4.		
	<b>8101</b>	2CLA810100A1001	10

### 2-way switches

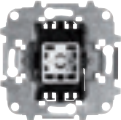
Product	Article-No.	Order-No.	Pack/Qty
	<b>Switch 1-gang, 2-way, single pole</b> Rated voltage: 110 - 250 Vac. Rated current: 10 AX. Screwless terminals. Included: fixing claws. Optional: locator LED lamp 6192 BL (230 Vac). Rocker code: 8501, 8501.2, 8501.3 & 8501.4.		
	<b>8102</b>	2CLA810200A1001	10

	<b>Switch 1-gang, 2-way, single pole 16A</b> Rated voltage: 110 - 250 Vac. Rated current: 16 AX. Screwless terminals. Included: fixing claws. Optional: locator LED lamp 6192 BL (230 Vac). Rocker code: 8501, 8501.2, 8501.3 & 8501.4.		
	<b>8102.1</b>	2CLA810210A1001	10

### Intermediate switches

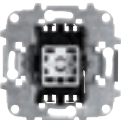
Product	Article-No.	Order-No.	Pack/Qty
	<b>Switch 1-gang, intermediate, single pole</b> Rated voltage: 110 - 250 Vac. Rated current: 10 AX. Screwless terminals. Included: fixing claws. Optional: locator LED lamp 6192 BL (230 Vac). Rocker code: 8501, 8501.2, 8501.3 & 8501.4.		
	<b>8110</b>	2CLA811000A1001	10

### Double pole switches

Product	Article-No.	Order-No.	Pack/Qty
	<b>Switch 1-gang, 1-way, double pole 16A</b> Rated voltage: 110 - 250 Vac. Rated current: 16 AX. Screwless terminals. Included: fixing claws. Optional: locator/indicator LED lamp 6192 BL (230 Vac). Rocker code: 8501, 8501.2, 8501.3 & 8501.4.		
	<b>8101.1</b>	2CLA810110A1001	10

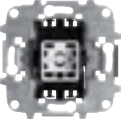
	<b>Switch 1-gang, 1-way, double pole</b> Rated voltage: 110 - 250 Vac. Rated current: 10 AX. Screwless terminals. Included: fixing claws. Optional: locator/indicator LED lamp 6192 BL (230 Vac). Rocker code: 8501, 8501.2, 8501.3 & 8501.4.		
	<b>8101.2</b>	2CLA810120A1001	10

### Switches with indicator lamp

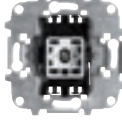
Product	Article-No.	Order-No.	Pack/Qty
	<b>Switch 1-gang, 1-way, single pole</b> Rated voltage: 110 - 250 Vac. Rated current: 10 AX. Screwless terminals. Included: fixing claws. 3 wire connection (neutral conductor required). Included: indicator LED lamp 6192 BL (230 Vac). Rocker code: 8501.3 & 8501.4.		
	<b>8101.5</b>	2CLA810150A1001	10

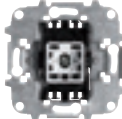
	<b>Switch 1-gang, 2-way, single pole</b> Rated voltage: 110 - 250 Vac. Rated current: 10 AX. Screwless terminals. Included: fixing claws. 4 wire connection (neutral conductor required). Indicator: indicator LED lamp 6192 BL (230 Vac). Rocker code: 8501.3 & 8501.4.		
	<b>8102.5</b>	2CLA810250A1001	10

### Push-buttons

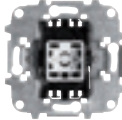
Product	Article-No.	Order-No.	Pack/Qty
	<b>Push-button 1-gang, single pole, NO</b> Rated voltage: 110 - 250 Vac. Rated current: 10 AX. NO: Normally Open. Screwless terminals. Included: fixing claws. Optional: locator LED lamp 6192 BL (230 Vac). Rocker code: 8501, 8501.3, 8504, 8504.2, 8504.3 & 8504.4.		
	<b>8104</b>	2CLA810400A1001	10

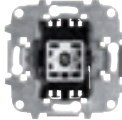
	<b>Push-button 1-gang, SP, NO w/ locator lamp</b> Rated voltage: 110 - 250 Vac. Rated current: 10 AX. NO: Normally Open. Screwless terminals. Included: fixing claws. 3 wire connection (neutral conductor required). Included: locator LED lamp 6192 BL (230 Vac). Rocker code: 8501.3, 8504.3 & 8504.4.		
	<b>8104.5</b>	2CLA810450A1001	10

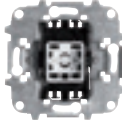
	<b>Push-button 1-gang, single pole, NC</b> Rated voltage: 110 - 250 Vac. Rated current: 10AX. NC: normally closed. Screwless terminals. Included: fixing claws. Optional: locator LED lamp 6192 BL (230 Vac). Rocker code: 8501, 8501.3, 8504, 8504.2, 8504.3 & 8504.4.		
	<b>8104.9</b>	2CLA810490A1001	5

## Sky Niessen

### Rockers for switches and push-buttons

Color	Article-No.	Order-No.	Pack/Qty
	<b>Rocker for switch, 1-gang</b> Rocker for switches code: 8101, 8101.1, 8101.2, 8102, 8102.1 & 8110.		
Soft White	<b>8501 BL</b>	2CLA850100A1101	20
Silver	<b>8501 PL</b>	2CLA850100A1301	20
Soft Black	<b>8501 NS</b>	2CLA850100A1501	20
Stainless Steel	<b>8501 AI</b>	2CLA850100A1401	20
Antique Gold	<b>8501 OE</b>	2CLA850100A1201	20
White Glass	<b>8501 CB</b>	2CLA850100A2101	10
Black Glass	<b>8501 CN</b>	2CLA850100A2501	10

	<b>Rocker with On/Off symbol, 1-gang</b> Rocker for switches code: 8101, 8101.1, 8101.2, 8102, 8102.1 & 8110.		
Soft White	<b>8501.2 BL</b>	2CLA850120A1101	5
Silver	<b>8501.2 PL</b>	2CLA850120A1301	5
Soft Black	<b>8501.2 NS</b>	2CLA850120A1501	5
Stainless Steel	<b>8501.2 AI</b>	2CLA850120A1401	5
Antique Gold	<b>8501.2 OE</b>	2CLA850120A1201	5

	<b>Rocker for switch with lens, 1-gang</b> Rocker for switches code: 8101, 8101.1, 8101.2, 8101.5, 8102, 8102.1, 8102.5 & 8110.		
Soft White	<b>8501.3 BL</b>	2CLA850130A1101	10
Silver	<b>8501.3 PL</b>	2CLA850130A1301	10
Soft Black	<b>8501.3 NS</b>	2CLA850130A1501	10
Stainless Steel	<b>8501.3 AI</b>	2CLA850130A1401	10
Antique Gold	<b>8501.3 OE</b>	2CLA850130A1201	10
White Glass	<b>8501.3 CB</b>	2CLA850130A2101	5
Black Glass	<b>8501.3 CN</b>	2CLA850130A2501	5

	<b>Rocker with lens &amp; On/Off symbol, 1-gang</b> Rocker for switches code: 8101, 8101.1, 8101.2, 8101.5, 8102, 8102.1, 8102.5 & 8110.		
Soft White	<b>8501.4 BL</b>	2CLA850140A1101	5
Silver	<b>8501.4 PL</b>	2CLA850140A1301	5
Soft Black	<b>8501.4 NS</b>	2CLA850140A1501	5
Stainless Steel	<b>8501.4 AI</b>	2CLA850140A1401	5
Antique Gold	<b>8501.4 OE</b>	2CLA850140A1201	5

### Rockers with symbols

Color	Article-No.	Order-No.	Pack/Qty
	<b>Rocker with bell symbol, 1-gang</b> Rocker for push-buttons code: 8104 & 8104.9.		
Soft White	<b>8504 BL</b>	2CLA850400A1101	10
Silver	<b>8504 PL</b>	2CLA850400A1301	10
Soft Black	<b>8504 NS</b>	2CLA850400A1501	10
Stainless Steel	<b>8504 AI</b>	2CLA850400A1401	10
Antique Gold	<b>8504 OE</b>	2CLA850400A1201	10

	<b>Rocker with light symbol, 1-gang</b> Rocker for push-buttons code: 8104 & 8104.9.		
Soft White	<b>8504.2 BL</b>	2CLA850420A1101	10
Silver	<b>8504.2 PL</b>	2CLA850420A1301	10
Soft Black	<b>8504.2 NS</b>	2CLA850420A1501	10
Stainless Steel	<b>8504.2 AI</b>	2CLA850420A1401	10
Antique Gold	<b>8504.2 OE</b>	2CLA850420A1201	10

	<b>Rocker with bell symbol &amp; lens, 1-gang</b> Rocker for push-buttons code: 8104, 8104.5 & 8104.9.		
Soft White	<b>8504.3 BL</b>	2CLA850430A1101	5
Silver	<b>8504.3 PL</b>	2CLA850430A1301	5
Soft Black	<b>8504.3 NS</b>	2CLA850430A1501	5
Stainless Steel	<b>8504.3 AI</b>	2CLA850430A1401	5
Antique Gold	<b>8504.3 OE</b>	2CLA850430A1201	5

	<b>Rocker with light symbol &amp; lens, 1-gang</b> Rocker for push-buttons code: 8104, 8104.5 & 8104.9.		
Soft White	<b>8504.4 BL</b>	2CLA850440A1101	5
Silver	<b>8504.4 PL</b>	2CLA850440A1301	5
Soft Black	<b>8504.4 NS</b>	2CLA850440A1501	5
Stainless Steel	<b>8504.4 AI</b>	2CLA850440A1401	5
Antique Gold	<b>8504.4 OE</b>	2CLA850440A1201	5

### Indicator / locator LED lamp

Product	Article-No.	Order-No.	Pack/Qty
	<b>Indicator/locator LED lamp 230Vac</b> For 81XX inserts. Lamp: white LED. Long life cycle. Two functions: indicator or locator light. Power consumption: 0,2 mA. Especially recommended for LED and energy saving lamps.		
	<b>6192 BL</b>	2CLA819202A1001	10

## Sky Niessen

### 2-gang switches & push-buttons

Product	Article-No.	Order-No.	Pack/Qty
	<b>Switch 2-gangs, 1-way, single pole</b> Rated voltage: 110 - 250 Vac. Rated current: 10 AX. Screwless terminals. Included: fixing claws. Rocker code: 8511.		
	<b>8111</b>	2CLA811100A1001	10

	<b>Switch 2-gangs, 2-way, single pole</b> Rated voltage: 110 - 250 Vac. Rated current: 10 AX. Screwless terminals. Included: fixing claws. Rocker code: 8511.		
	<b>8122</b>	2CLA812200A1001	10

	<b>Push-button 2-gangs, single pole, NO</b> Rated voltage: 110 - 250 Vac. Rated current: 10 AX. Screwless terminals. Without interlock. Included: fixing claws. Rocker code: 8511.		
	<b>8144.2</b>	2CLA814420A1001	10

	<b>Rocker for switch/push-button, 2-gangs</b> Rocker for switch/push-buttons code: 8111, 8122, 8144.2 & 8142.		
Soft White	<b>8511 BL</b>	2CLA851100A1101	20
Silver	<b>8511 PL</b>	2CLA851100A1301	20
Soft Black	<b>8511 NS</b>	2CLA851100A1501	20
Stainless Steel	<b>8511 AI</b>	2CLA851100A1401	20
Antique Gold	<b>8511 OE</b>	2CLA851100A1201	20
White Glass	<b>8511 CB</b>	2CLA851100A2101	10
Black Glass	<b>8511 CN</b>	2CLA851100A2501	10

	<b>Switch 2-way + push-button 1-way NO, SP</b> Rated voltage: 110 - 250 Vac. Rated current: 10 AX. Screwless terminals. Included: fixing claws. Rocker code: 8511 & 8542.		
	<b>8142</b>	2CLA814200A1001	10

	<b>Rocker for switch + push-button, 2-gangs</b> Rocker for switch + push-buttons code: 8142.		
Soft White	<b>8542 BL</b>	2CLA854200A1101	5
Silver	<b>8542 PL</b>	2CLA854200A1301	5
Soft Black	<b>8542 NS</b>	2CLA854200A1501	5
Stainless Steel	<b>8542 AI</b>	2CLA854200A1401	5
Antique Gold	<b>8542 OE</b>	2CLA854200A1201	5

### Card switches

Product	Article-No.	Order-No.	Pack/Qty
	<b>Card switch 1-gang, 1-way, double pole</b> Rated voltage: 110 - 250 Vac. Rated current: 10 AX. For 54mm width cards. Included: fixing claws. Included: locator LED lamp 6192 BL (230 Vac). Cover plate code: 8514.		
	<b>8114</b>	2CLA811400A1001	10

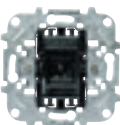
	<b>Card switch 1-gang, 1-way, double pole 16A</b> Rated voltage: 110 - 250 Vac. Rated current: 16 AX. For 54mm width cards. Included: fixing claws. Included: locator LED lamp 6192 BL (230 Vac). Cover plate code: 8514.		
	<b>8114.1</b>	2CLA811410A1001	10

	<b>Card switch 1-gang, 2-way, double pole</b> Rated voltage: 110 - 250 Vac. Rated current: 10 AX. For 54mm width cards. Included: fixing claws. Included: locator LED lamp 6192 BL (230 Vac). Cover plate code: 8514.		
	<b>8114.2</b>	2CLA811420A1001	10

	<b>Card switch 1-gang, 1-way, SP w/ time delay</b> Rated voltage: 110 - 250 Vac ; 50 / 60 Hz. Rated current: - Incandescent/halogen: 3.000W@230Vac / 1.600W@127Vac. - Fluorescent: 1.300VA@230Vac / 700VA@127Vac. - Electronic and ferromag. transf. and motors: 3.000VA@230Vac / 1.600VA@127Vac. 3 wire connection (neutral conductor required). For 54 mm. width cards. Locator LED lamp included. Time delayed switch: 5 - 90 seconds. Cover plate code: 8514.		
	<b>8114.5</b>	2CLA811450A1001	1

	<b>Cover plate for card switch with lens</b> Cover plate for card switch code: 8114, 8114.1, 8114.2 & 8114.5.		
Soft White	<b>8514 BL</b>	2CLA851400A1101	10
Silver	<b>8514 PL</b>	2CLA851400A1301	10
Soft Black	<b>8514 NS</b>	2CLA851400A1501	10
Stainless Steel	<b>8514 AI</b>	2CLA851400A1401	10
Antique Gold	<b>8514 OE</b>	2CLA851400A1201	10





## Sky Niessen

### Key switches

Product	Article-No.	Order-No.	Pack/Qty
	<b>Key switch 1-way, 2 positions, single pole</b> Rated voltage: 110 - 250 Vac. Rated current: 5 A. Key removable in the 2 positions. Unique key for each lock. Suitable for alarms. Cover plate code: 8553.		
	<b>8153</b>	2CLA815300A1001	1

	<b>Key push button 1-way, 2 positions, SP</b> Rated voltage: 110 - 250 Vac. Rated current: 5 A. Key removable in "OFF" position. Unique key for each lock. Suitable for alarms. Cover plate code: 8553.		
	<b>8153.2</b>	2CLA815320A1001	1

	<b>Cover plate for 2 position key switch</b> Cover plate for key switch code: 8153 & 8153.2.		
Soft White	<b>8553 BL</b>	2CLA855300A1101	1
Silver	<b>8553 PL</b>	2CLA855300A1301	1
Soft Black	<b>8553 NS</b>	2CLA855300A1501	1
Stainless Steel	<b>8553 AI</b>	2CLA855300A1401	1
Antique Gold	<b>8553 OE</b>	2CLA855300A1201	1

	<b>Key switch 2-way, 3 positions, single pole</b> Rated voltage: 110 - 250 Vac. Rated current: 150 mA. Key removable in "OFF" position. Unique key for each lock. Suitable for blinds, shutters, etc. Cover plate code: 8553.1.		
	<b>8153.1</b>	2CLA815310A1001	1

	<b>Cover plate for 3 position key switch</b> Cover plate for key switch code: 8153.1.		
Soft White	<b>8553.1 BL</b>	2CLA855310A1101	1
Silver	<b>8553.1 PL</b>	2CLA855310A1301	1
Soft Black	<b>8553.1 NS</b>	2CLA855310A1501	1
Stainless Steel	<b>8553.1 AI</b>	2CLA855310A1401	1
Antique Gold	<b>8553.1 OE</b>	2CLA855310A1201	1

## Blind controls

Product	Article-No.	Order-No.	Pack/Qty
	<b>Push-button blind control 2-gangs</b> Rated voltage: 110 - 250 Vac. Rated current: 10 AX. Direct control. Interlocked gangs. Included: fixing claws. Rocker code: 8544.		
	<b>8144</b>	2CLA814400A1001	10

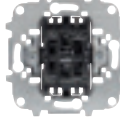
	<b>Switch blind control 2-gangs</b> Rated voltage: 110 - 250 Vac. Rated current: 10 AX. Direct control. Interlocked gangs. Included: fixing claws. Rocker code: 8544.		
	<b>8144.1</b>	2CLA814410A1001	10

	<b>Rocker for blind switch/push-button</b> Rocker for blind switch/push-button code: 8144 & 8144.1.		
Soft White	<b>8544 BL</b>	2CLA854400A1101	10
Silver	<b>8544 PL</b>	2CLA854400A1301	10
Soft Black	<b>8544 NS</b>	2CLA854400A1501	10
Stainless Steel	<b>8544 AI</b>	2CLA854400A1401	10
Antique Gold	<b>8544 OE</b>	2CLA854400A1201	10
White Glass	<b>8544 CB</b>	2CLA854400A2101	5
Black Glass	<b>8544 CN</b>	2CLA854400A2501	5

	<b>Electronic blind control 1-gang</b> Rated voltage: 110 - 250 Vac ; 50 / 60 Hz. Rated current: 700VA@230Vac / 350VA@127Vac. Direct control. Functions: - PERS: standard blinds control. Optionally other 8144 inserts can be connected to the 8130.3 to control the blind from other locations. - LAM: venetian type blinds control. Optionally other 8144 inserts can be connected to the 8130.3 to control the blind from other locations. - Centralization (CEN): one 8130.3 can control all the 8130.3 of a line centrally. Included: fixing claws. Electronic rocker code: 8530.		
	<b>8130.3</b>	2CLA813030A1001	1

	<b>Electronic rocker for blind control</b> Electronic rocker for blind control code: 8130.3.		
Soft White	<b>8530 BL</b>	2CLA853000A1101	1
Silver	<b>8530 PL</b>	2CLA853000A1301	1
Soft Black	<b>8530 NS</b>	2CLA853000A1501	1
Stainless Steel	<b>8530 AI</b>	2CLA853000A1401	1
Antique Gold	<b>8530 OE</b>	2CLA853000A1201	1

## Sky Niessen

### Pullcord switches

Product	Article-No.	Order-No.	Pack/Qty
 <p><b>Pullcord switch 1-gang, 1-way, single pole</b>            Rated voltage: 110 - 250 Vac.            Rated current: 16 A.            Screwless terminals.            Included: fixing claws.            Cord length: 2 meters.            Cover plate code: 8507.</p>	<b>8148</b>	2CLA814800A1001	5



#### Cover for pull cord switch

Cover plate for pullcord switch code: 8148.

Soft White	<b>8507 BL</b>	2CLA850700A1101	10
Silver	<b>8507 PL</b>	2CLA850700A1301	10
Soft Black	<b>8507 NS</b>	2CLA850700A1501	10
Stainless Steel	<b>8507 AI</b>	2CLA850700A1401	10
Antique Gold	<b>8507 OE</b>	2CLA850700A1201	10

# Sky Niessen

## Schuko socket outlets

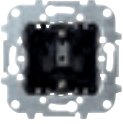
Product	Article-No.	Order-No.	Pack/Qty
	<b>Schuko socket outlet</b> Rated voltage: 250 Vac. Rated current: 16 A. Type F: 2P + E. Shuttered for child safety. Screw terminals. Without fixing claws code: 8188. With fixing claws code: 8188.5. Cover plate code: 8588.		
	<b>8188</b>	2CLA818800A1001	10
	<b>8188.5</b>	2CLA818850A1001	10

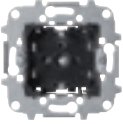
	<b>Schuko socket outlet screwless connection</b> Rated voltage: 250 Vac. Rated current: 16 A. Type F: 2P + E. Shuttered for child safety. Screwless terminals. Without fixing claws. Cover plate code: 8588.		
	<b>8188.6</b>	2CLA818860A1001	10

	<b>Cover plate for Schuko socket outlet</b> Cover plate for Schuko socket outlet code: 8188, 8188.5 & 8188.6.		
Soft White	<b>8588 BL</b>	2CLA858800A1101	20
Silver	<b>8588 PL</b>	2CLA858800A1301	20
Soft Black	<b>8588 NS</b>	2CLA858800A1501	20
Stainless Steel	<b>8588 AI</b>	2CLA858800A1401	20
Antique Gold	<b>8588 OE</b>	2CLA858800A1201	20
White Glass	<b>8588 CB</b>	2CLA858800A2101	10
Black Glass	<b>8588 CN</b>	2CLA858800A2501	10

	<b>Cover plate for Schuko socket outlet</b> Suitable to identify special circuits. Cover plate for Schuko socket outlet code: 8188, 8188.5 & 8188.6.		
Red	<b>8588 RJ</b>	2CLA858800A7001	5
Green	<b>8588 VD</b>	2CLA858800A8001	5
Orange	<b>8588 NA</b>	2CLA858800A9001	5

	<b>Cover plate for Schuko socket outlet w/ lid</b> Cover plate for Schuko socket outlet code: 8188, 8188.5 & 8188.6.		
Soft White	<b>8588.1 BL</b>	2CLA858810A1101	10
Silver	<b>8588.1 PL</b>	2CLA858810A1301	10
Soft Black	<b>8588.1 NS</b>	2CLA858810A1501	10
Stainless Steel	<b>8588.1 AI</b>	2CLA858810A1401	5
Antique Gold	<b>8588.1 OE</b>	2CLA858810A1201	5

Product	Article-No.	Order-No.	Pack/Qty
	<b>Schuko socket outlet with indicator lamp</b> Rated voltage: 250 Vac. Rated current: 16 A. Type F: 2P + E. Shuttered for child safety. Screw terminals. Without fixing claws. Included: indicator LED lamp. Cover plate code: 8588.8		
	<b>8188.8</b>	2CLA818880A1001	5

	<b>Cover plate for Schuko socket outlet w/ lens</b> Cover plate for Schuko socket outlet code: 8188.8.		
Soft White	<b>8588.8 BL</b>	2CLA858880A1101	10
Silver	<b>8588.8 PL</b>	2CLA858880A1301	10
Soft Black	<b>8588.8 NS</b>	2CLA858880A1501	10
Stainless Steel	<b>8588.8 AI</b>	2CLA858880A1401	10
Antique Gold	<b>8588.8 OE</b>	2CLA858880A1201	10

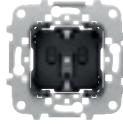
	<b>Schuko socket outlet for plain covers</b> Rated voltage: 250 Vac. Rated current: 16 A. Type F: 2P + E. Shuttered for child safety. Screw terminals. Without fixing claws. Cover plate code: 8588.9.		
	<b>8188.9</b>	2CLA818890A1001	10

	<b>Flat cover plate for Schuko socket outlet</b> Cover plate for Schuko socket outlet code: 8188.9.		
Soft White	<b>8588.9 BL</b>	2CLA858890A1101	20
Silver	<b>8588.9 PL</b>	2CLA858890A1301	20
Soft Black	<b>8588.9 NS</b>	2CLA858890A1501	20
Stainless Steel	<b>8588.9 AI</b>	2CLA858890A1401	20
Antique Gold	<b>8588.9 OE</b>	2CLA858890A1201	20
White Glass	<b>8588.9 CB</b>	2CLA858890A2101	10
Black Glass	<b>8588.9 CN</b>	2CLA858890A2501	10

## Sky Niessen

### French / earth-pin socket outlets

Product	Article-No.	Order-No.	Pack/Qty
	<b>French/Earth-pin socket outlet</b> Rated voltage: 250 Vac. Rated current: 16 A. Type E: 2P + E. Shuttered for child safety. Screw terminals. Included: fixing claws. Cover plate code: 8587.		
	<b>8187</b>	2CLA818700A1001	10



**Cover plate for French socket outlet**  
Cover plate for Schuko socket outlet code: 8187.

Soft White	<b>8587 BL</b>	2CLA858700A1101	20
Silver	<b>8587 PL</b>	2CLA858700A1301	20
Soft Black	<b>8587 NS</b>	2CLA858700A1501	20
Stainless Steel	<b>8587 AI</b>	2CLA858700A1401	20
Antique Gold	<b>8587 OE</b>	2CLA858700A1201	20



**French/Earth-pin socket outlet for plain covers**  
Rated voltage: 250 Vac.  
Rated current: 16 A.  
Type E: 2P + E.  
Shuttered for child safety.  
Screwless terminals.  
Included: fixing claws.  
Cover plate code: 8587.9.

**8187.9** 2CLA818790A1001 10



**Flat cover plate for French socket outlet**  
Cover plate for French / earth-pin socket outlet code: 8187.9.

Soft White	<b>8587.9 BL</b>	2CLA858790A1101	10
Silver	<b>8587.9 PL</b>	2CLA858790A1301	10
Soft Black	<b>8587.9 NS</b>	2CLA858790A1501	10
Stainless Steel	<b>8587.9 AI</b>	2CLA858790A1401	10
Antique Gold	<b>8587.9 OE</b>	2CLA858790A1201	10
White Glass	<b>8587.9 CB</b>	2CLA858790A2101	10
Black Glass	<b>8587.9 CN</b>	2CLA858790A2501	10

### Push-buttons

Product	Article-No.	Order-No.	Pack/Qty
	<b>Universal socket outlet</b> Rated voltage: 125 / 250 Vac. Rated current: 15 / 16 A. Multiple type: 2P + E. Shuttered for child safety. Screw terminals. Without fixing claws. Cover plates: - Euroamerican type (Type B+C: 2P + E / NEMA 5-15R): 8538. - Universal type (Multiple type: 2P + E): 8539.		
	<b>8139</b>	2CLA813900A1001	10



**Cover plate for Euroamerican socket outlet**  
Cover plate with Euroamerican type figure for universal socket outlet code: 8139.

Soft White	<b>8538 BL</b>	2CLA853800A1101	10
Silver	<b>8538 PL</b>	2CLA853800A1301	10
Soft Black	<b>8538 NS</b>	2CLA853800A1501	10
Stainless Steel	<b>8538 AI</b>	2CLA853800A1401	10
Antique Gold	<b>8538 OE</b>	2CLA853800A1201	10



**Cover plate for Universal socket outlet**  
Cover plate with universal type figure for universal socket outlet code: 8139.

Soft White	<b>8539 BL</b>	2CLA853900A1101	10
Silver	<b>8539 PL</b>	2CLA853900A1301	10
Soft Black	<b>8539 NS</b>	2CLA853900A1501	10
Stainless Steel	<b>8539 AI</b>	2CLA853900A1401	10
Antique Gold	<b>8539 OE</b>	2CLA853900A1201	10



**British standard socket outlet - 2M**  
Rated voltage: 250 Vac.  
Rated current: 13A.  
Type G: 2P + E.  
Without switch.  
Shuttered for child safety.  
Screw terminals.  
Cover plate for British socket type: 8537.

**8137** 2CLA813700A1001 10





**Cover plate for British socket outlet**  
Cover plate with British type figure for universal socket outlet code: 8137.

Soft White	<b>8537 BL</b>	2CLA853700A1101	10
Silver	<b>8537 PL</b>	2CLA853700A1301	10
Soft Black	<b>8537 NS</b>	2CLA853700A1501	10
Stainless Steel	<b>8537 AI</b>	2CLA853700A1401	10
Antique Gold	<b>8537 OE</b>	2CLA853700A1201	10



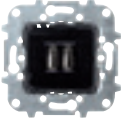

## Sky Niessen USB chargers

Product	Article-No.	Order-No.	Pack/Qty
 <p><b>USB charger 1.500mA, 2 outlets</b>                      Input voltage: 100 - 240 Vac ±10% ; 50 / 60 Hz.                      Input current: 0,20 A (with maximum load).                      Output voltage: 5 Vdc ±5%.                      Output current: 1.500 mA (total for both gangs).                      Power consumption in stand-by: ≤ 0,3W@230Vac.                      Energy efficiency: ≥ 71%.                      Operating temperature: 0 °C to 35 °C.                      Mounting grid delivered with the cover plate (without fixing claws).                      Cover plate code: 8585.</p>	<b>8185</b>	2CLA818500A1001	1

 <p><b>Cover plate for USB charger 1,5 A</b>                      Cover plate for USB charger code: 8185.</p>			
Soft White	<b>8585 BL</b>	2CLA858500A1101	5
Silver	<b>8585 PL</b>	2CLA858500A1301	5
Soft Black	<b>8585 NS</b>	2CLA858500A1501	5
Stainless Steel	<b>8585 AI</b>	2CLA858500A1401	5
Antique Gold	<b>8585 OE</b>	2CLA858500A1201	5

Product	Article-No.	Order-No.	Pack/Qty
 <p><b>USB charger 2.000 mA, 1 outlet</b>                      Input voltage: 100 - 230 Vac ±10% ; 50 / 60 Hz.                      Input current: 0,20 A (with maximum load).                      Output voltage: 5 Vdc ±5%.                      Output current: 2.000 mA.                      Power consumption in stand-by: ≤ 0,01W@230Vac.                      Energy efficiency: ≥ 79%.                      Operating temperature: 0 °C to 45 °C.                      Without fixing claws.                      Cover plate code: 8585.2.</p>	<b>8185.2</b>	2CLA818520A1001	1





 <p><b>Cover plate for USB charger 2A</b>                      Cover plate for USB charger code: 8185.2.</p>			
Soft White	<b>8585.2 BL</b>	2CLA858520A1101	1
Silver	<b>8585.2 PL</b>	2CLA858520A1301	1
Soft Black	<b>8585.2 NS</b>	2CLA858520A1501	1
Stainless Steel	<b>8585.2 AI</b>	2CLA858520A1401	1
Antique Gold	<b>8585.2 OE</b>	2CLA858520A1201	1

 <p><b>USB charger 2x 2.000mA, 2 outlets</b>                      Input voltage: 100 - 230 Vac ±10%; 50/60 Hz.                      Input current: 0,20 A (with maximum load).                      Output voltage: 5 Vdc ±5%.                      Output current: 2.000 mA.                      Power consumption in stand-by: ≤ 0,01W@230Vac.                      Energy efficiency: ≥ 79%.                      Operating temperature: 0 °C to 45 °C.                      Without fixing claws.                      Cover plate code: 8585.3.</p>	<b>8185.3</b>	2CLA818530A1001	1
--	---------------	-----------------	---

 <p><b>Cover plate for USB charger 2x 2 A</b>                      Cover plate for USB charger code: 8185.3.</p>			
Soft White	<b>8585.3 BL</b>	2CLA858530A1101	1
Silver	<b>8585.3 PL</b>	2CLA858530A1301	1
Soft Black	<b>8585.3 NS</b>	2CLA858530A1501	1
Stainless Steel	<b>8585.3 AI</b>	2CLA858530A1401	1
Antique Gold	<b>8585.3 OE</b>	2CLA858530A1201	1

## Sky Niessen

### Protection devices

Product	Article-No.	Order-No.	Pack/Qty
 <p><b>Circuit breaker 6A &amp; RCD 10mA</b>            Rated voltage: 120 - 230 Vac ; 50 / 60 Hz.            Rated current: 6 A.            Braking capacity: 1.500 A.            Residual current (sensitivity - IΔn): 10 mA.            C type magneto-thermic protection.            A type residual current protection.            Two-pole (1P + N) with 1 protected pole.            Without fixing claws.            Cover plate code: 8534.</p>	<b>8134.1</b>	2CLA813410A1001	1
 <p><b>Circuit breaker 10A &amp; RCD 10mA</b>            Rated voltage: 120 - 230 Vac ; 50 / 60 Hz.            Rated current: 10 A.            Braking capacity: 3.000 A.            Residual current (sensitivity - IΔn): 10 mA.            C type magneto-thermic protection.            A type residual current protection.            Two-pole (1P + N) with 1 protected pole.            Without fixing claws.            Cover plate code: 8534.</p>	<b>8134.2</b>	2CLA813420A1001	1
 <p><b>Circuit breaker 16A &amp; RCD 10mA</b>            Rated voltage: 120 - 230 Vac ; 50 / 60 Hz.            Rated current: 16 A.            Braking capacity: 3.000 A.            Residual current (sensitivity - IΔn): 10 mA.            C type magneto-thermic protection.            A type residual current protection.            Two-pole (1P + N) with 1 protected pole.            Without fixing claws.            Cover plate code: 8534.</p>	<b>8134.3</b>	2CLA813430A1001	1
 <p><b>Cover plate for circuit breaker &amp; RCD</b>            Cover plate for circuit breaker &amp; RCD code:            8134.1, 8134.2 &amp; 8134.3.</p>			
Soft White	<b>8534 BL</b>	2CLA853400A1101	1
Silver	<b>8534 PL</b>	2CLA853400A1301	1
Soft Black	<b>8534 NS</b>	2CLA853400A1501	1
Stainless Steel	<b>8534 AI</b>	2CLA853400A1401	1
Antique Gold	<b>8534 OE</b>	2CLA853400A1201	1

# Sky Niessen

## TV outlets

Product	Article-No.	Order-No.	Pack/Qty
	<b>TV / R terminal outlet</b> TV and R double outlet - Final. Without filter. Installation as a terminal outlet connected to a tap-off or splitter (without terminal resistor). Connection: screw terminal and clamp. Output connectors (C1 / C2): IEC male 9,52mm diam. / IEC female 9,52 mm. diam. Frequency range (I/O / C1 / C2): 5 - 862 MHz / 5 - 862 MHz / 5 - 862 MHz. Basic loss (FM / DAB / VHF / UHF): 10,0±0,7 dB / 10,0 ±1,5 dB / 4,0±1,5 dB / 3,0±0,5 dB. Isolation (FM / TV): >14 / >14. Return loss (FM / TV): >18 / >10. Included: fixing claws. Cover plate code: 8550.		
	<b>8150</b>	2CLA815000A1001	10

	<b>TV / R final outlet - CATV outlet</b> TV and R double outlet - CATV outlet - Final. With filter. Installation as a terminal outlet connected to a tap-off or splitter (without terminal resistor). Connection: screw terminal and clamp. Output connectors (C1 / C2): IEC male 9,52 mm. diam. / IEC female 9,52 mm. diam. Frequency range (C1 / C2): 5 - 68 & 118 - 1.000 MHz / 87,5 - 108 MHz. Basic loss (R / FM / TV): 0,3±0,1 dB / 1,1 ±0,3 dB / 0,9±0,3 dB. Isolation (FM / TV): >18 / >16. Selectivity (FM / TV): >10 / >18. Return loss (R / FM / TV): >18 / >16 / >18. Chroma-luminance delay (ns): <10. Included: fixing claws. Cover plate code: 8550.		
	<b>8150.3</b>	2CLA815030A1001	10

	<b>TV / R loop-through outlet</b> TV and R double outlet - Intermediate. Installation as an intermediate outlet in series connected to each other. From 2nd to 4th floor. Connection: screw terminal and clamp. Output connectors (C1 / C2): IEC male 9,52mm diam. / IEC female 9,52 mm. diam. Frequency range (I/O / C1 / C2): 13 - 862 MHz / 13 - 862 MHz / 13 - 862 MHz. Basic loss (FM / DAB / VHF / UHF): 25±1,5 dB / 25 ±1,5 dB / 8,0±0,7 dB / 8,0±0,7 dB. Through loss (FM / VHF / UHF): 2,0±0,3 dB / 2,0±0,5 dB / 2,0±0,5 dB. Directivity (FM / TV): >12 dB / >9 dB. Isolation (FM / TV): >16 / >15. Return loss (FM / TV): >12 / >12. Included: fixing claws. Cover plate code: 8550.		
	<b>8150.7</b>	2CLA815070A1001	10

	<b>Cover plate for TV/R outlet</b> Cover plate for TV outlet code: 8150, 8150.3 & 8150.7.		
Soft White	<b>8550 BL</b>	2CLA855000A1101	20
Silver	<b>8550 PL</b>	2CLA855000A1301	20
Soft Black	<b>8550 NS</b>	2CLA855000A1501	20
Stainless Steel	<b>8550 AI</b>	2CLA855000A1401	20
Antique Gold	<b>8550 OE</b>	2CLA855000A1201	20

Product	Article-No.	Order-No.	Pack/Qty
	<b>TV-R/SAT terminal outlet</b> TV-R and SAT double outlet - Final. Installation as a terminal outlet connected to a tap-off or splitter (without terminal resistor). Connection: screw terminal and clamp. Output connectors (C1 / C2): IEC male 9,52 mm. diam. / IEC female 9,52 mm. diam. Frequency range (I/O / C1 / C2): 5 - 2.400 MHz / 5 - 862 MHz / 930 - 2.400 MHz. Basic loss (FM / TV / SAT): 0,2±0,1 dB / 1,0 ±0,5 dB / 1,2±0,6 dB. Isolation (FM / TV / SAT): >45 / >14 / >14. Selectivity (TV-R / SAT): >15 / >15. Return loss (VR / FM / TV / SAT): >25 / >25 / >14 / >10. DC path (Vdc / mA / Tono): 24 max. / 500 max. / 22 KHz - DiSEqC. Included: fixing claws. Cover plate code: 8550.1.		
	<b>8151.3</b>	2CLA815130A1001	10

	<b>TV-R/SAT final outlet</b> TV-R and SAT double outlet - Final. Installation as a terminal outlet connected to a series with loop-through outlets. Connection: screw terminal and clamp. Output connectors (C1 / C2): IEC male 9,52 mm. diam. / IEC female 9,52 mm. diam. Frequency range (I/O / C1 / C2): 5 - 2.400 MHz / 5 - 2.400 MHz / 5 - 2.400 MHz. Basic loss (FM / TV / SAT): 3,7±0,3 dB / 4,0±0,5 dB / 5,0±1,2 dB. Isolation (FM / TV / SAT): >20 / >20 / >14. Return loss (VR / FM / TV / SAT): >16 / >16 / >16 / >9. DC path (Vdc / mA / Tono): 24 max. / 500 max. / 22 KHz - DiSEqC. Included: fixing claws. Cover plate code: 8550.1.		
	<b>8151.7</b>	2CLA815170A1001	10

	<b>TV-R/SAT loop-through outlet</b> TV-R and SAT double outlet - Intermediate Installation as an intermediate outlet in series connected to each other. Output connectors (C1 / C2): IEC male 9,52 mm. diam. / IEC female 9,52 mm. diam. Frequency range (I/O / C1 / C2): 5 - 2.400 MHz / 5 - 2.400 MHz / 5 - 2.400 MHz. Basic loss (FM / TV / SAT): 10,0±1,0 dB / 10,0±1,0 dB / 12,0±2,0 dB. Through loss (FM / TV / SAT): 2,5±0,5 / 2,5±0,7 / 3,0±1,0. Directivity (FM / TV / SAT): >20 / >12 / >5. Isolation (FM / TV / SAT): >45 / >30 / >28. Return loss (VR / FM / TV / SAT): >13 / >13 / >12 / >12. DC path (Vdc / mA / Tono): 24 max. / 500 max. / 22 KHz - DiSEqC. Included: fixing claws. Cover plate code: 8550.1.		
	<b>8151.8</b>	2CLA815180A1001	10

	<b>Cover plate for TV-R/SAT outlet</b> Cover plate for TV outlet code: 8151.3, 8150.7 & 8150.8.		
Soft White	<b>8550.1 BL</b>	2CLA855010A1101	20
Silver	<b>8550.1 PL</b>	2CLA855010A1301	20
Soft Black	<b>8550.1 NS</b>	2CLA855010A1501	20
Stainless Steel	<b>8550.1 AI</b>	2CLA855010A1401	20
Antique Gold	<b>8550.1 OE</b>	2CLA855010A1201	20

## Sky Niessen

### Telephone & data outlets

Product	Article-No.	Order-No.	Pack/Qty
	<b>Telephone outlet RJ12</b> RJ12 type connector. 6 contacts. Suitable for 2 (6P2C), 4 (6P4C) or 6 (6P6C) RJ11 and RJ12 jacks. Screw terminals. Without fixing claws. Cover plate code: 8517.		
	<b>8117</b>	2CLA811700A1001	10

	<b>Data outlet RJ45 Cat.5e UTP</b> RJ45 type connector. Cat.5e UTP. In compliance with ANSI/TIA/EIA 568B.2, ISO/IEC11801 & EN50173. Universal TIA/EIA 568A and 568B labeling. Housing: ABS UL-94-0. Durability: 750 cycles min. (ISO/IEC 11801, IEC 60603-7-4) IDC: PC UL94V-0, Accept 22-26AWG solid wire. Contact: RJ45 8P8C, 3~50 micro-inch gold plating over nickel plated on contact area. Tool-less wiring. Without fixing claws. Cover plate code: 8517.		
	<b>8118</b>	2CLA811800A1001	10





**Cover plate for telephone/data outlets**  
Cover plate for telephone/data outlet code: 8117 & 8118.

Soft White	<b>8517 BL</b>	2CLA851700A1101	10
Silver	<b>8517 PL</b>	2CLA851700A1301	10
Soft Black	<b>8517 NS</b>	2CLA851700A1501	10
Stainless Steel	<b>8517 AI</b>	2CLA851700A1401	10
Antique Gold	<b>8517 OE</b>	2CLA851700A1201	10

Product	Article-No.	Order-No.	Pack/Qty
	<b>Telephone outlet RJ12</b> RJ12 type connector. 6 contacts. Suitable for 2 (6P2C), 4 (6P4C) or 6 (6P6C) RJ11 and RJ12 jacks. Screw terminals. Mounting grid delivered with the cover plate. Cover plate code: 8518.1 & 8518.2.		
	<b>2017.2</b>	2CLA201720A1001	10

	<b>Telephone outlet RJ45 Cat.3</b> RJ45 type connector. Cat.3. 8 contacts. Suitable for 8 (8P8C) RJ45 jacks. Tool-less wiring. Mounting grid delivered with the cover plate. Cover plate code: 8518.1 & 8518.2.		
	<b>2017.3</b>	2CLA201730A1001	10

	<b>Data outlet RJ45 Cat.5e UTP</b> RJ45 type connector. Cat.5e UTP. In compliance with ANSI/TIA/EIA 568B.2, ISO/IEC11801 & EN50173. Universal TIA/EIA 568A and 568B labeling. Housing: ABS UL-94-0. Durability: 750 cycles min. (ISO/IEC 11801, IEC 60603-7-4). IDC: PC UL94V-0, Accept 22-26AWG solid wire. Contact: RJ45 8P8C, 3~50 micro-inch gold plating over nickel plated on contact area. Tool-less wiring. Mounting grid delivered with the cover plate. Cover plate code: 8518.1 & 8518.2.		
	<b>2018.5</b>	2CLA201850A1001	10

	<b>Data outlet RJ45 Cat.6 UTP</b> RJ45 type connector. Cat.6 UTP. In compliance with ANSI/TIA/EIA 568B.2, ISO/IEC11801 & EN50173. Universal TIA/EIA 568A and 568B labeling. Housing: ABS UL-94-0. Durability: 750 cycles min. (ISO/IEC 11801, IEC 60603-7-4). IDC: PC UL94V-0, Accept 22-26AWG solid wire. Contact: RJ45 8P8C, 3~50 micro-inch gold plating over nickel plated on contact area. Tool-less wiring. Mounting grid delivered with the cover plate. Cover plate code: 8518.1 & 8518.2.		
	<b>2018.6</b>	2CLA201860A1001	10

	<b>Data outlet RJ45 Cat.6A STP</b> RJ45 type connector. Cat.6A STP. In compliance with ANSI/TIA/EIA 568B.2, ISO/IEC11801 & EN50173. Universal TIA/EIA 568A and 568B Labeling. 10 Gb/sec. Durability: 750 cycles min. (ISO/IEC 11801, IEC 60603-7-4). Housing: Zinc Die-casting design for optimal EMI protection. Slim size is ideal for interfaces where the spaces are tight. IDC: PC UL94V-0, Accept 22-26AWG solid wire. Contact: RJ45 8P8C, 3~50 micro-inch gold plating over nickel plated on contact area. Tool-less wiring. Mounting grid delivered with the cover plate. Cover plate code: 8518.1 & 8518.2.		
	<b>2018.7</b>	2CLA201870A1001	10



## Sky Niessen

### Telephone & data outlets

Product	Article-No.	Order-No.	Pack/Qty
	<b>Housing for data outlets - Keystone type</b> Housing for connectors with Keystone type clipping system. Mounting grid delivered with the cover plate. Cover plate code: 8518.1 & 8518.2.		
	<b>2018</b>	2CLA201800A1001	10

	<b>Housing for data outlets - Systimax type</b> Housing for connectors with Systimax type clipping system. Mounting grid delivered with the cover plate. Cover plate code: 8518.1 & 8518.2.		
	<b>2018.8</b>	2CLA201880A1001	10

	<b>Cover plate for data outlet 1-gang</b> Cover plate for data outlets code: 2017.2, 2017.3, 2018, 2018.5, 2018.6 & 2018.8. Included: - Mounting grid without claws. - Shutters. - Labeling area.		
Soft White	<b>8518.1 BL</b>	2CLA851810A1101	10
Silver	<b>8518.1 PL</b>	2CLA851810A1301	10
Soft Black	<b>8518.1 NS</b>	2CLA851810A1501	10
Stainless Steel	<b>8518.1 AI</b>	2CLA851810A1401	10
Antique Gold	<b>8518.1 OE</b>	2CLA851810A1201	10

	<b>Cover plate for data outlet 2-gangs</b> Cover plate for data outlets code: 2017.2, 2017.3, 2018, 2018.5, 2018.6 & 2018.8. Included: - Mounting grid without claws. - Shutters. - Labeling area.		
Soft White	<b>8518.2 BL</b>	2CLA851820A1101	10
Silver	<b>8518.2 PL</b>	2CLA851820A1301	10
Soft Black	<b>8518.2 NS</b>	2CLA851820A1501	10
Stainless Steel	<b>8518.2 AI</b>	2CLA851820A1401	10
Antique Gold	<b>8518.2 OE</b>	2CLA851820A1201	10

## Sky Niessen

### VDI connectors

Product	Article-No.	Order-No.	Pack/Qty
	<b>Mini-Jack connection unit</b> Front: 1x Mini-Jack connector (3,5mm stereo audio jack). Rear: screw terminals (3/4 wires). Without fixing claws. Cover plate code: 8555.		
	<b>8155.4</b>	2CLA815540A1001	1

	<b>HDMI connection unit</b> Front: 1x HDMI connector (Type A connector). Rear: screwless terminals (20 wires). Without fixing claws. Cover plate code: 8555.		
	<b>8155.6</b>	2CLA815560A1001	1

	<b>HDMI female-female connection unit</b> Front: 1x HDMI connector (Type A connector). Rear: 1x HDMI connector (Type A connector) fitted at 90° angle. Without fixing claws. Cover plate code: 8555.		
	<b>8155.7</b>	2CLA815570A1001	1

	<b>USB connection unit</b> Front: 1x USB 2.0 connector (Type A connector). Rear: screw terminals (5 wires). Without fixing claws. Cover plate code: 8555.		
	<b>8155.8</b>	2CLA815580A1001	1

	<b>USB female-female connection unit</b> Front: 1x USB 2.0 connector (Type A connector). Rear: 1x USB 2.0 connector (Type A connector) fitted at 90° angle. Without fixing claws. Cover plate code: 8555.		
	<b>8155.9</b>	2CLA815590A1001	1

	<b>Cover plate 1-gang VDI connection unit</b> Cover plate for 1-gang VDI connection unit code: 8155.4, 8155.6, 8155.7, 8155.8 & 8155.9.		
---	--	--	--

Soft White	<b>8555 BL</b>	2CLA855500A1101	1
Silver	<b>8555 PL</b>	2CLA855500A1301	1
Soft Black	<b>8555 NS</b>	2CLA855500A1501	1
Stainless Steel	<b>8555 AI</b>	2CLA855500A1401	1
Antique Gold	<b>8555 OE</b>	2CLA855500A1201	1

Product	Article-No.	Order-No.	Pack/Qty
	<b>HDMI wired + USB connection unit</b> Front: 1x HDMI connector (Type A connector) & 1x USB 2.0 connector (Type A connector). Rear: HDMI screwless terminals (20 wires) & USB screw terminals (5 wires). Without fixing claws. Cover plate code: 8555.1.		
	<b>8155.68</b>	2CLA815568A1001	1

	<b>HDMI female-female + USB connection unit</b> Front: 1x HDMI connector (Type A connector) & 1x USB 2.0 connector (Type A connector). Rear: 1x HDMI connector (Type A connector) fitted at 90° angle & USB screw terminals (5 wires). Without fixing claws. Cover plate code: 8555.1.		
	<b>8155.78</b>	2CLA815578A1001	1

	<b>Double USB connection unit</b> Front: 2x USB 2.0 connector (Type A connector). Rear: 2x USB screw terminals (5 wires). Without fixing claws. Cover plate code: 8555.1.		
	<b>8155.88</b>	2CLA815588A1001	1

	<b>Cover plate 2-gangs VDI connection unit</b> Cover plate for 2-gangs VDI connection unit code: 8155.68, 8155.78 & 8155.88.		
---	---	--	--

Soft White	<b>8555.1 BL</b>	2CLA855510A1101	1
Silver	<b>8555.1 PL</b>	2CLA855510A1301	1
Soft Black	<b>8555.1 NS</b>	2CLA855510A1501	1
Stainless Steel	<b>8555.1 AI</b>	2CLA855510A1401	1
Antique Gold	<b>8555.1 OE</b>	2CLA855510A1201	1

# Sky Niessen

## VDI connectors

Product	Article-No.	Order-No.	Pack/Qty
	<b>2x RCA connection unit</b> Front: 2x RCA connectors (Red / White). Rear: screw terminals (4 wires). Without fixing claws. Cover plate code: 8555.2.		
	<b>8155.2</b>	2CLA815520A1001	1

 <b>Cover plate 2RCA connection unit</b> Cover plate for 2RCA connection unit code: 8155.2.			
Soft White	<b>8555.2 BL</b>	2CLA855520A1101	1
Silver	<b>8555.2 PL</b>	2CLA855520A1301	1
Soft Black	<b>8555.2 NS</b>	2CLA855520A1501	1
Stainless Steel	<b>8555.2 AI</b>	2CLA855520A1401	1
Antique Gold	<b>8555.2 OE</b>	2CLA855520A1201	1

 <b>3x RCA connection unit</b> Front: 3x RCA connectors (Red / White / Yellow). Rear: screw terminals (6 wires). Without fixing claws. Cover plate code: 8555.3.			
	<b>8155.3</b>	2CLA815530A1001	1

 <b>Cover plate 3RCA connection unit</b> Cover plate for 3RCA connection unit code: 8155.3.			
Soft White	<b>8555.3 BL</b>	2CLA855530A1101	1
Silver	<b>8555.3 PL</b>	2CLA855530A1301	1
Soft Black	<b>8555.3 NS</b>	2CLA855530A1501	1
Stainless Steel	<b>8555.3 AI</b>	2CLA855530A1401	1
Antique Gold	<b>8555.3 OE</b>	2CLA855530A1201	1

 <b>VGA connection unit</b> Front: 1x VGA connector (DE-15 connector). Rear: screw terminals (15 wires). Without fixing claws. Cover plate code: 8555.5.			
	<b>8155.5</b>	2CLA815550A1001	1

 <b>Cover plate VGA connection unit</b> Cover plate for VGA connection unit code: 8155.5.			
Soft White	<b>8555.5 BL</b>	2CLA855550A1101	1
Silver	<b>8555.5 PL</b>	2CLA855550A1301	1
Soft Black	<b>8555.5 NS</b>	2CLA855550A1501	1
Stainless Steel	<b>8555.5 AI</b>	2CLA855550A1401	1
Antique Gold	<b>8555.5 OE</b>	2CLA855550A1201	1

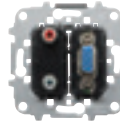
Product	Article-No.	Order-No.	Pack/Qty
	<b>VGA + 2RCA connection unit</b> Front: 1x VGA connector (DE-15 connector) & 2x RCA connectors (Red / White). Rear: VGA screw terminals (15 wires) & RCA screw terminals (4 wires). Without fixing claws. Cover plate code: 8555.6.		
	<b>8155.52</b>	2CLA815552A1001	1

 <b>Cover plate VGA + 2RCA connection unit</b> Cover plate for VGA + 2RCA connection unit code: 8155.52.			
Soft White	<b>8555.6 BL</b>	2CLA855560A1101	1
Silver	<b>8555.6 PL</b>	2CLA855560A1301	1
Soft Black	<b>8555.6 NS</b>	2CLA855560A1501	1
Stainless Steel	<b>8555.6 AI</b>	2CLA855560A1401	1
Antique Gold	<b>8555.6 OE</b>	2CLA855560A1201	1

 <b>VGA + mini-Jack connection unit</b> Front: 1x VGA connector (DE-15 connector) & 1x Mini-Jack connector (3,5mm stereo audio jack). Rear: VGA screw terminals (15 wires) & Mini-jack screw terminals (3/4 wires). Without fixing claws. Cover plate code: 8555.4.			
	<b>8155.54</b>	2CLA815554A1001	1

 <b>Cover plate VGA + mini-jack connection unit</b> Cover plate for VGA + mini-jack connection unit code: 8155.54.			
Soft White	<b>8555.4 BL</b>	2CLA855540A1101	1
Silver	<b>8555.4 PL</b>	2CLA855540A1301	1
Soft Black	<b>8555.4 NS</b>	2CLA855540A1501	1
Stainless Steel	<b>8555.4 AI</b>	2CLA855540A1401	1
Antique Gold	<b>8555.4 OE</b>	2CLA855540A1201	1

## Sky Niessen

### Light controls - Rotatory dimmers

Product	Article-No.	Order-No.	Pack/Qty
	<b>Rotatory dimmer, RL, 20-500 W</b> Rated voltage: 230 V~ ; ± 10% - 50 Hz. With rotatory control, 2-way On-Off switching and soft-catch. Leading Edge control. Rated power: 20 - 500 W / VA. For incandescent lamps, 230 V tungsten halogen lamps and low-volt halogen lamps with conventional transformer. With adjustable minimum brightness. In the case of conventional transformers, take ~20% transformer loss into account. Provided with terminal for net disconnection devices. Also applicable for 1gang 2way installations. Included: fixing claws. Cover plate code: 8560.2.		
	<b>8160</b>	2CLA816000A1001	1

	<b>Rotatory dimmer, LED, 2-100 W</b> Rated voltage: 230 V~ ; ± 10% - 50/60 Hz. Nominal power: 2 - 100 W/VA (retrofit LED loads). Nominal power: 10 - 250 W/VA (non-LED loads). With rotatory control, 2-way switch and soft-catch. 2-wire connection (neutral conductor not required). Optimised for dimming of retrofit LED lamps (LEDi). For dimming dimmable Retrofit-LEDs (LEDi) and dimmable Retrofit-LEDs (LEDi) with conventional or electronic transformers, for incandescent lamps, 230 V tungsten halogen lamps, low-voltage halogen lamps with conventional or electronic transformers and dimmable energy-saving halogen lamps. Mix operation of LEDi with conventional loads possible. Switch adjustable: leading and trailing edge control. Low-noise level by MOSFET transistors. With electronic short-circuit and overload protection. With adjustable minimum brightness. Temperature range device: 0 °C to 35 °C. In the case of conventional transformers, take ~20% transformer loss into account. In case of electronic transformers, 5 % transformer losses. Also applicable for 1gang 2way installations. Provided with terminal for net disconnection devices. Included: fixing claws. Cover plate code: 8560.2.		
	<b>8160.2</b>	2CLA816020A1001	1

	<b>Rotatory dimmer, RL, 200-700 W</b> Rated voltage: 230 V~ ; ± 10% - 50 Hz. With rotatory control, 2way On-Off switching and soft-catch. Leading Edge control. Rated power: 200 - 700 W / VA. For incandescent lamps, 230 V tungsten halogen lamps and low-volt halogen lamps with conventional transformer. Short-circuit-proof, overload-protected. With adjustable minimum brightness. Without cover plate. Without fixing claws. In the case of conventional transformers, take ~20% transformer loss into account. Provided with terminal for net disconnection devices. Cover plate code: 8560.2.		
	<b>8160.3</b>	2CLA816030A1001	1

	<b>Rotatory dimmer, RL, 60-400 W</b> Rated voltage: 230 V~ ; ± 10% - 50 Hz. 1 channel designed as dimmer. 1 channel designed as switch contact (1-gang 2-way contact element) with leading edge control. Rated power: 60 - 400 W / VA. For incandescent lamps, 230 V tungsten halogen lamps and low-volt halogen lamps with conventional transformer. With adjustable minimum brightness. Rated current 6A (changeover contact switch output). In the case of conventional transformers, take ~20% transformer loss into account. Can be used to replace a 2 gang 1 way switch. Included: fixing claws. Cover plate code: 8560.2.		
	<b>8160.5</b>	2CLA816050A1001	1

Product	Article-No.	Order-No.	Pack/Qty
	<b>Rotatory dimmer, RC, 40-420 W</b> Rated voltage: 230 V~ ; ± 10% - 50 Hz. With rotatory control, soft-catch and with trailing edge control. Rated power: 40 - 420 W / VA. For incandescent lamps, 230 V tungsten halogen lamps and low-voltage halogen lamps with electronic transformers. Low-noise, short-circuit-proof, overload-protected. Not suitable with conventional transformers. In case of electronic transformers, 5 % transformer losses. Provided with terminal for net disconnection devices. Also applicable for 1gang 2 way installations. Included: fixing claws. Cover plate code: 8560.2.		
	<b>8160.7</b>	2CLA816070A1001	1

	<b>Rotatory dimmer, RLC, 60-420 W</b> Rated voltage: 230 V~ ; ± 10% - 50/60 Hz. With soft-catch. With intelligence for universal operation. Rated power: 60 - 420 W / VA. For incandescent lamps, 230 V tungsten halogen lamps and low-voltage halogen lamps with conventional transformers or electronic transformers. Short-circuit-proof, overload-protected. Capacity expansion via output-side, parallel connectable load line with a power module 6594 U up to 735 W/VA possible. Remote operation via rotatory-type remote control 8161.8 possible. In case of electronic transformers, 5 % transformer losses. In the case of conventional transformers, take ~20% transformer loss into account. Cannot be combined with a 2way switch. Included: fixing claws. Cover plate code: 8560.2.		
	<b>8160.8</b>	2CLA816080A1001	1

	<b>Rotatory dimmer, 1-10Vdc</b> Rated voltage: 230 V~ ; ± 10% - 50/60 Hz. Rated power: 700 W / VA. With rotatory control. For controlling ballast units for fluorescent lamps with control output 1-10 V DC, control current max. 50 mA DC. For LED control via control drivers. Without cover plate. Not illuminable. Making-current limiters have to be provided in case of too high making currents. Included: fixing claws. Cover plate code: 8560.2.		
	<b>8160.9</b>	2CLA816090A1001	1





	<b>Rotatory dimmer remote control</b> Rated voltage: 230 V~ ; ± 10% - 50/60 Hz. To be used with dimmer code 8160.8. With soft-catch. A maximum of 5 multi-way extensions can be connected to a 8160.8 dimmer. Included: fixing claws. Cover plate code: 8560.2.		
	<b>8161.8</b>	2CLA816180A1001	1

	<b>Cover plate with rotatory knob for dimmer</b> Cover plate with rotatory knob for dimmer code: 8160, 8160.2, 8160.3, 8160.5, 8160.7, 8160.8, 8160.9 & 8161.8. Included: indicator neon lamp.		
Soft White	<b>8560.2 BL</b>	2CLA856020A1101	5
Silver	<b>8560.2 PL</b>	2CLA856020A1301	5
Soft Black	<b>8560.2 NS</b>	2CLA856020A1501	5
Stainless Steel	<b>8560.2 AI</b>	2CLA856020A1401	5
Antique Gold	<b>8560.2 OE</b>	2CLA856020A1201	5





## Sky Niessen

### Light controls - Push dimmers

Product	Article-No.	Order-No.	Pack/Qty
	<b>Rotatory dimmer remote control</b> Rated voltage: 230 V~ ; ± 10% - 50 Hz. Rated power: 60 - 450 W / VA. For dimming and switching of incandescent lamps, 230 V halogen lamps and low-voltage halogen lamps with conventional or electronic transformers. 2-wire connection (neutral conductor not required). With soft ON/OFF function. With electronic short-circuit protection. With automatic overtemperature protection. With operating mode switch for operating mode: dimmer, switch. Dimmer operating mode: short press on the upper rocker switch half to switch the light on, short press on the lower rocker switch half to switch the light off. Dimmer operating mode: long press on the upper rocker switch half dims, with light switched on, the light brighter, or with light switched off the light brighter from nothing. Long press on the lower rocker switch half dims the light darker. Switch operating mode: press on the upper rocker switch half to switch the light on, press on the lower rocker switch half to switch the light off. Operation also possible via conventional push buttons 8104.X. Do not operate conventional transformers and electronic transformers together on the universal dimmer switch insert. Inputs: 1. Polling voltage: 230 V~, Sensing pulse, L-wire. Outputs: 1 electronic output, potential-bound. Suitable for: ohmic, capacitive and inductive loads. Temperature range device: 0 °C to 35 °C. Included: attachable claws. In the case of conventional transformers, take ~20% transformer loss into account. In case of electronic transformers, 5 % transformer losses. Electronic cover plate: 8530.		
	<b>8130</b>	2CLA813000A1001	1
	<b>Electronic rocker for dimmer switch</b> Electronic rocker for dimmer switch control code: 8130.		
Soft White	<b>8530 BL</b>	2CLA853000A1101	1
Silver	<b>8530 PL</b>	2CLA853000A1301	1
Soft Black	<b>8530 NS</b>	2CLA853000A1501	1
Stainless Steel	<b>8530 AI</b>	2CLA853000A1401	1
Antique Gold	<b>8530 OE</b>	2CLA853000A1201	1
	<b>Universal push dimmer 40-450W</b> Rated voltage: 127 - 230 Vac - 50/60 Hz Min. power: 40 W. Max. power: - Incandescent: 450W @230Vac / 250W @127Vac. - Halogen with transformer: 400VA @230Vac / 250VA @127Vac. 2 wire connection. Optional: auxiliary control with 8104.X push-buttons. Overcurrent protection: with fuse. Indicator LED lamp included. Operating temperature: 0 - 30 °C. Without fixing claws. Cove plate code: 8560.1.		
	<b>8160.1</b>	2CLA816010A1001	1
	<b>Cover plate for universal push dimmer</b> Cover plate for universal push dimmer code: 8160.1.		
Soft White	<b>8560.1 BL</b>	2CLA856010A1101	5
Silver	<b>8560.1 PL</b>	2CLA856010A1301	5
Soft Black	<b>8560.1 NS</b>	2CLA856010A1501	5
Stainless Steel	<b>8560.1 AI</b>	2CLA856010A1401	5
Antique Gold	<b>8560.1 OE</b>	2CLA856010A1201	5

### Light controls - DALI controllers

Product	Article-No.	Order-No.	Pack/Qty
	<b>Rotatory DALI dimmer</b> For DALI broadcast service (via central telegram). For switching and dimming up to 64 DALI- devices like electronic ballasts and transformers with DALI-interface. With rotatory control and ON/OFF push operation. Fool proof. Brightness power-on level and background brightness level adjustable, buffered. With integrated LED illumination for orientation. Color of orientation light adjustable (18 presets and OFF). Up to 5 potentiometers are connectable in parallel. Max. current consumption: 15 mA. Not suitable for combining with other DALI sensors or central units of other manufacturers. An additional DALI power supply is needed. Max. DALI-cable length: 300 m (1,5 - 2,5 mm <sup>2</sup> ). Temperature range device: 0 °C to 35 °C Included: fixing claws Cover plate code: 8560.2		
	<b>8161.4</b>	2CLA816140A1001	1
	<b>Rotatory DALI dimmer with power supply</b> Rated voltage: 230 V~ ; ± 10% - 50/60 Hz. For DALI broadcast service (via central telegram). With integrated DALI power adaptor. For switching and dimming up to 64 DALI- devices like electronic ballasts and transformers with DALI-interface. With rotatory control and ON/OFF push operation. With electronic short-circuit protection. With electronic overload protection. Brightness power-on level and background brightness level adjustable, buffered. With integrated LED illumination for orientation. Color of orientation light adjustable (18 presets and OFF). Up to 5 potentiometers are connectable in parallel. Up to 3 potentiometers are connectable in parallel in active mode. Not suitable for combining with other DALI sensors or central units of other manufacturers. DALI-voltage: 15,5 V= Rated current: max. 75 mA. Power consumption: < 2,5 W. Number of DALI-units: 37 in case of one active power-potentiometer. In case of three active power-potentiometer in parallel connection: 111. Active mode: the potentiometer is supporting the necessary control circuit for other DALI-devices. Passive mode: the potentiometer is suitable as additional operation point. Max. DALI-cable length: 300 m (1,5 - 2,5 mm <sup>2</sup> ). Temperature range device: 0 °C to 35 °C. Included: fixing claws. Cover plate code: 8560.2.		
	<b>8161.5</b>	2CLA816150A1001	1
	<b>Cover plate with rotatory knob for dimmer</b> Cover plate with rotatory knob for dimmer code: 8161.4 & 8161.5.		
Soft White	<b>8560.2 BL</b>	2CLA856020A1101	5
Silver	<b>8560.2 PL</b>	2CLA856020A1301	5
Soft Black	<b>8560.2 NS</b>	2CLA856020A1501	5
Stainless Steel	<b>8560.2 AI</b>	2CLA856020A1401	5
Antique Gold	<b>8560.2 OE</b>	2CLA856020A1201	5

## Sky Niessen

### Light controls - Timer switches

Product	Article-No.	Order-No.	Pack/Qty
	<b>Universal single relay time delayed switch</b> Rated voltage: 230 V~ ; ± 10% - 50 Hz. For switching incandescent lamps, 230 V tungsten halogen lamps, fluorescent lamps and low-voltage halogen lamps, that are actuated via transformers. 3 wire connection (neutral conductor required). With operating mode switch for operating mode: switch, time switch. Switch operating mode: press on the upper rocker switch half to switch the light on, press on the lower rocker switch half to switch the light off. Time switch operating mode: press on the upper rocker switch half to switch the light on, the light automatically switches off after a time delay. Manual switching off not possible. The delay can be set in 5 steps between 30 and 300 secs. Operation also possible via conventional push buttons 8104.X. Inputs: 1. Polling voltage: 230 V~, Sensing pulse, L-wire. Outputs: 1 Normally open contact, potential-bound. Suitable for: ohmic, capacitive and inductive loads. Rated current: 10 AX. Rated power: 2300 W / VA. Included: attachable claws. Electronic cover plate code: 8530.		
	<b>8130.1</b>	2CLA813010A1001	1

	<b>Universal double relay time delayed switch</b> Rated voltage: 230 V~ ; ± 10% - 50 Hz. For switching incandescent lamps, 230 V tungsten halogen lamps, fluorescent lamps and low-voltage halogen lamps, that are actuated via transformers. 3 wire connection (neutral conductor required). With operating mode switch for operating mode: switch, time switch. Switch operating mode: press on the upper rocker switch half to switch the light on, press on the lower rocker switch half to switch the light off. Time switch operating mode: press on the upper rocker switch half to switch the light on, the light automatically switches off after a time delay. Manual switching off not possible. The delay can be set in 5 steps between 30 and 300 secs. Operation also possible via conventional push buttons 8104.X. Inputs: 1. Polling voltage: 230 V~, Sensing pulse, L-wire. Outputs: 2 Normally open contacts, potential-bound. Suitable for: ohmic, capacitive and inductive loads. Rated current: 2x 3 AX. Rated power: 2x 700 W / VA. Included: attachable claws. Electronic cover plate code: 8530.		
	<b>8130.2</b>	2CLA813020A1001	1

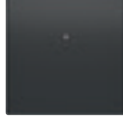

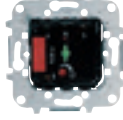
Product	Article-No.	Order-No.	Pack/Qty
	<b>Electronic rocker for time delayed switch</b> Electronic rocker for time delayed switch code: 8130.1 & 8130.2.		
Soft White	<b>8530 BL</b>	2CLA853000A1101	1
Silver	<b>8530 PL</b>	2CLA853000A1301	1
Soft Black	<b>8530 NS</b>	2CLA853000A1501	1
Stainless Steel	<b>8530 AI</b>	2CLA853000A1401	1
Antique Gold	<b>8530 OE</b>	2CLA853000A1201	1

	<b>Time delayed switch with triac</b> Rated voltage: 230 Vac - 50 Hz. Power: - Incandescent: 40 - 500 W. - Halogen with transformer: 40 - 400 VA. - Motors: 40 - 100 VA. 2 wire connection. Delay setup: 10 sec. to 10 min. Overcurrent protection: with fuse. Indicator LED lamp included. Without fixing claws. Operating temperature: 0 - 40 °C. Cover plate code: 8562.		
	<b>8162.1</b>	2CLA816210A1001	1





	<b>Cover plate for timer switch</b> Cover plate for timer switch code: 8162.1.		
Soft White	<b>8562 BL</b>	2CLA856200A1101	1
Silver	<b>8562 PL</b>	2CLA856200A1301	1
Soft Black	<b>8562 NS</b>	2CLA856200A1501	1
Stainless Steel	<b>8562 AI</b>	2CLA856200A1401	1
Antique Gold	<b>8562 OE</b>	2CLA856200A1201	1

## Sky Niessen

### Light controls - Motion sensors

Product	Article-No.	Order-No.	Pack/Qty
	<b>MOS-Fet switch for motion sensor</b> Rated voltage: 230 V~ ; ± 10% - 50/60 Hz. 2-wire connection (neutral conductor not required). For 8541.1 motion sensor. Operation also possible via conventional push buttons 8104.X. Rated power: 60 - 420 W / VA. Suitable for: 230 V incandescent lamps, 230 V halogen lamps, low-voltage halogen lamps with conventional transformers. Temperature range device: 0 °C to 35 °C. In case of electronic transformers, 5 % transformer losses. In the case of conventional transformers, take ~20% transformer loss into account. Not suitable for the activation of energy-saving lamps, conventional and electronic ballast units and LED lamps. Not suitable for activating the staircase time delay. Cannot be used to control relays. Included: fixing claws.		
	<b>8141.3</b>	2CLA814130A1001	1
	<b>Relay switch for motion sensor</b> Rated voltage: 230 V ; ± 10% - 50 Hz. 3 wire connection (neutral conductor required). For 8141.1 motion sensor. Outputs: 1 Normally open contact, potential-bound. Suitable for: 230 V incandescent lamps, 230 V halogen lamps, fluorescent lamps and low-voltage halogen lamps, that are operated via transformers. Rated power: 700 W / VA. Temperature range device: 0 °C to 55 °C. Included: fixing claws.		
	<b>8141.4</b>	2CLA814140A1001	1
	<b>180° motion sensor</b> For automatic switching of devices dependent on motion and brightness. For relay inserts 8141.4. For MOS-Fet insert 8141.3. With integrated selector switch for ON-AUTOMATIC-OFF (lockable). Surveillance density: 18 sectors with 72 switching segments. Switch-off delay: 10 sec to 30 min or short-time pulse 1 sec adjustable. Temperature range device: 0 °C to 35 °C. Detection range: frontal: 12 m, lateral: 8 m. Brightness limit value: from 5 lux up to daytime operation. Detection angle: 180 °. Mounting height: 0.8 m - 1.2 m.		
Soft White	<b>8541.1 BL</b>	2CLA854110A1101	1
Silver	<b>8541.1 PL</b>	2CLA854110A1301	1
Soft Black	<b>8541.1 NS</b>	2CLA854110A1501	1
Stainless Steel	<b>8541.1 AI</b>	2CLA854110A1401	1
Antique Gold	<b>8541.1 OE</b>	2CLA854110A1201	1

### Light controls - Programmable switches

Product	Article-No.	Order-No.	Pack/Qty
	<b>Relay switch</b> Rated voltage: 230 V~ ; ± 10% - 50/60 Hz. 3 wire connection (neutral conductor required). For timer control element 8165.31. Operation also possible via conventional push buttons 8104.X. Outputs: 1 Normally open contact, potential-bound. Suitable for: 230 V incandescent lamps, 230 V halogen lamps, fluorescent lamps and low-voltage halogen lamps, that are operated via transformers. Rated current: 10 AX. Rated power: 2300 W / VA. Temperature range device: -25 °C to 55 °C. Included: fixing claws.		
	<b>8161</b>	2CLA816100A1001	1
	<b>Relay switch for blinds</b> Rated voltage: 230 V~ ; ± 10% - 50 Hz. Suitable for blind, roller blind and awning drives with mechanical or electronic limit switch shut-off. Two 230 V multi-way input terminals (Up/Down) for group control. Operating mode switch for the following modes: normal, louvre, base station, position. Wind alarm, cleaning functions can be accommodated via extension input. For comfort timer control element 8565.31. Remote control with blind controls code: 8144.X. Running time: 3 min. Outputs: 2 Normally open contact. Rated current: 3 A, cos φ0.5. Rated power: 690 VA. Control/Signal outputs: 2. Temperature range device: 0 °C to 35 °C. Included: fixing claws.		
	<b>8161.2</b>	2CLA816120A1001	1
	<b>Timer control element</b> For manual and time-controlled switching of blinds, roller blinds, awnings, lighting and other electrical devices. With dusk to dawn program including (Astro-program). Individual Astro adjustment and Astro blocking time. The controlled devices can be manually operated at any time. Simple setting via high-resolution display with background illumination. With preset switching times/date/time. Factory-set switching times can be individually adjusted. Automatic switchover from summer time to winter time (switch-off function). Switching times/programme are safely stored in the event of a mains power failure. Power reserve for time and date > 10 years. Simple toggling between manual/automatic/vacation modes. Freely adjustable temperature and brightness-dependent sun protection function. Freely adjustable twilight function. User-adjustable running times for blinds and air conditioning. Programming possible only with control element attached and energized. 6 switching times per day can be user-defined for each day of the week. Astro switching times and switching times can be combined. For blind control insert 8161.2. For universal relay switch insert 8161. Temperature range device: 0 °C to 35 °C. Cover plate code: 8565.3.		
	<b>8165.31</b>	2CLA816530A1101	1
	<b>Cover plate for timer control element</b> Cover plate for timer control element code: 8165.31.		
Soft White	<b>8565.3 BL</b>	2CLA856530A1101	1
Silver	<b>8565.3 PL</b>	2CLA856530A1301	1
Soft Black	<b>8565.3 NS</b>	2CLA856530A1501	1
Stainless Steel	<b>8565.3 AI</b>	2CLA856530A1401	1
Antique Gold	<b>8565.3 OE</b>	2CLA856530A1201	1

## Sky Niessen

### Light controls - Wireless control

Product	Article-No.	Order-No.	Pack/Qty
	<b>Wireless switch transmitter - 1 channel</b> 1-gang wall-mounted transmitter independent of mains power supply. 1 radio channel for switching, dimming, controlling blinds or 2 light scenes can be called up. For wireless actuators: 8130.4, 8130.5, 8130.7 & 8130.6. Send frequency: 868 MHz. Free-field range: approx. 100 m. Power supply: lithium button cell battery type CR2032. Battery service life: typically 5 years, therefore practically maintenance-free. Rated voltage: 3 Vdc. Automatic monitoring of battery life. Including fixing plate for mounting on smooth walls or on switch boxes. Control element: switch contacts top/bottom. Display elements: LED to indicate the transmission. Temperature range device: -5 °C to 45 °C. Battery included in delivery.		
Soft White	<b>8531.1 BL</b>	2CLA853110A1101	1
Silver	<b>8531.1 PL</b>	2CLA853110A1301	1
Soft Black	<b>8531.1 NS</b>	2CLA853110A1501	1

Product	Article-No.	Order-No.	Pack/Qty
	<b>Wireless switch transmitter - 2 channel</b> 2-gang wall-mounted transmitter independent of mains power supply. 2 radio channel for switching, dimming, controlling blinds or 4 light scenes can be called up. For wireless actuators: 8130.4, 8130.5, 8130.7 & 8130.6. Send frequency: 868 MHz. Free-field range: approx. 100 m. Power supply: lithium button cell battery type CR2032. Battery service life: typically 5 years, therefore practically maintenance-free. Rated voltage: 3 Vdc. Automatic monitoring of battery life. Including fixing plate for mounting on smooth walls or on switch boxes. Control element: switch contacts top/bottom. Display elements: LED to indicate the transmission. Temperature range device: -5 °C to 45 °C. Battery included in delivery.		
Soft White	<b>8531.2 BL</b>	2CLA853120A1101	1
Silver	<b>8531.2 PL</b>	2CLA853120A1301	1
Soft Black	<b>8531.2 NS</b>	2CLA853120A1501	1

Product	Article-No.	Order-No.	Pack/Qty
	<b>Wireless switch actuator</b> Rated voltage: 230 Vac ; ± 10% - 50/60 Hz. For wireless switching of electrical loads. 2 functions: ON/OFF switch or time delayed switch. For wall mounted transmitter code: 8531.1 & 8531.2. Switch-off delay: 3 sec. / 1 min. / 5 min. / 15 min. Repeater function can be activated for extended range. For universal attachment or installation. 3 wire connection (neutral conductor required). With auxiliary input for push-buttons code: 8104.X. Send/receive frequency: 868 MHz. Free-field range: approx. 100 m. Control element: adjustable potentiometer. Display elements: status indication of output via LED. Outputs: 1x Normally Open or Normally Closed contact, 230 Vac. Rated power: - Incandescent, halogen, electronic transformer and ferromagnetic transformers: 2.300 W / VA. - Fluorescent load: 1.000 VA. Temperature range (device): -5 °C to 45 °C. Dimensions: (L x W x D): 47 mm. x 48 mm. x 22 mm.		
	<b>8130.4</b>	2CLA813040A1001	1

Product	Article-No.	Order-No.	Pack/Qty
	<b>Wireless dimming actuator</b> Rated voltage: 230 Vac ; ± 10% - 50/60 Hz. For wireless switching and dimming of electrical loads. For functions ON/OFF switch and dimming. For wall mounted transmitter code: 8531.1 & 8531.2. Repeater function can be activated for extended range. For universal attachment or installation. 2-wire connection (neutral conductor not required) 3-wire connection system (neutral conductor is required) is preferred when using electronic transformers, electromagnetic transformers and energy saving lamps. With auxiliary input for push-buttons code: 8104.X. Send/receive frequency: 868 MHz. Free-field range: approx. 100 m. Control element: adjustable potentiometer Display elements: status indication of output via LED. Outputs: 1 dimming channel, 230Vac Rated power: - Incandescent lamps: 35 - 300 W - Low voltage halogen lamps, which are operated by electronic transformers: 35 - 200 VA - Low voltage halogen lamps with conventional transformers: 35 - 175 VA Temperature range device: -5 °C to 45 °C Dimensions: (L x W x D): 47 mm x 48 mm x 33 mm		
	<b>8130.5</b>	2CLA813050A1001	1

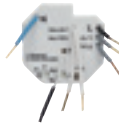
Product	Article-No.	Order-No.	Pack/Qty
	<b>Wireless blind actuator</b> Rated voltage: 230 Vac ; ± 10% - 50/60 Hz. For wireless switching of electrical loads or controlling blinds/shutters. 2 functions: 2-gang switch or blind control. Operation also possible via conventional blind controls code 8144.X or push-buttons 8104.X. For wall mounted transmitter code: 8531.1 & 8531.2. With blind switch function: 3 minutes run time. Repeater function can be activated for extended range. For universal attachment or installation. 3 wire connection (neutral conductor required). Send/receive frequency: 868 MHz. Free-field range: approx. 100 m. Control element: adjustable potentiometer. Display elements: status indication of output via LED. Inputs: 2. Polling voltage: 230 V~, Sensing pulse, L-wire. Outputs: 2 Normally Open contact, 230 Vac. Rated power: - Blind motors: 3 A, cos φ 0.5. - Incandescent/halogen lamps: 3 A. - Fluorescent lamps: 3 AX. Temperature range device: -5 °C to 45 °C. Dimensions: (L x W x D): 47 mm. x 48 mm. x 22 mm.		
	<b>8130.7</b>	2CLA813070A1001	1

Product	Article-No.	Order-No.	Pack/Qty
	<b>Wireless DIN-rail actuator</b> Rated voltage: 230 Vac ; ± 10% - 50/60 Hz. For wireless switching of electrical loads. 2 functions: ON/OFF switch or time delayed switch. For wall mounted transmitter code: 8531.1 & 8531.2. Switch-off delay: 3 sec. / 1 min. / 5 min. / 10 min. / 30 min. Repeater function can be activated for extended range. For DIN-rail installation. 3 wire connection (neutral conductor required). Send/receive frequency: 868 MHz. Free-field range: approx. 30 m. Control element: adjustable potentiometer. Display elements: status indication of output via LED. Outputs: 1x Normally Open or Normally Closed contact, 230 Vac. Rated power: - Incandescent, halogen, electronic transformer and ferromagnetic transformers: 2.300 W / VA. - Fluorescent load: 1.000 VA. Temperature range device: -5 °C to 45 °C. Dimensions: 1 module.		
	<b>8130.6</b>	2CLA813060A1001	1



## Sky Niessen

### Light controls - Rotatory switch

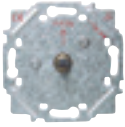
Product	Article-No.	Order-No.	Pack/Qty
	<b>4 position rotatory switch</b> Rated voltage: 110 - 250 Vac. Rated current: 16 AX. 4 positions. 4 circuits. Faston terminals. Without fixing claws. Cover plate code: 8554.		
	<b>8154</b>	2CLA815400A1001	10



**Cover plate with knob for rotatory switch**  
Cover plate for rotatory switch code: 8154.

Soft White	<b>8554 BL</b>	2CLA855400A1101	1
Silver	<b>8554 PL</b>	2CLA855400A1301	1
Soft Black	<b>8554 NS</b>	2CLA855400A1501	1
Stainless Steel	<b>8554 AI</b>	2CLA855400A1401	1
Antique Gold	<b>8554 OE</b>	2CLA855400A1201	1

### Temperature controls - RTC

Product	Article-No.	Order-No.	Pack/Qty
	<b>Digital room thermostat</b> Rated voltage: 230 Vac - 50/60 Hz. Power consumption: < 1W Operating temperature range: + 0 °C to 50 °C. Measurement accuracy: ±2 °C (± 1 °C with calibration). Resolution: 0.1 °C. Control output: Potential-free relay contacts Normally. Open (NO). Maximum load: 3A cos = 0,5. Output relay operation modes: - Hysteresis: 0.5 °C. - Pulse-width modulation: with a ±4 °C difference with the set-point temperature, variable from 100% to 0% modulation. Mounting grid delivered with the cover plate (without fixing claws). Cover plate code: 8540.5.		
	<b>8140.5</b>	2CLA814050A1001	1



**Cover plate for digital thermostat**  
Cover plate for room thermostat code: 8140.5.

Soft White	<b>8540.5 BL</b>	2CLA854050A1101	5
Silver	<b>8540.5 PL</b>	2CLA854050A1301	5
Soft Black	<b>8540.5 NS</b>	2CLA854050A1501	5
Stainless Steel	<b>8540.5 AI</b>	2CLA854050A1401	1
Antique Gold	<b>8540.5 OE</b>	2CLA854050A1201	1



**Rotatory room thermostat with floor sensor**  
Rated voltage: 230 Vac ; ±10 % - 50/60 Hz.  
Load power: 2.300 W.  
Load type: floor heating resistor.  
Control temperature: +5 °C to +45 °C (Set point).  
OFF state: At OFF position, the thermostat is off, so that it does not address the temperature measured by the floor temperature probe. The relay output contact is open.  
Temperature accuracy: 0,5 °C.  
Hysteresis: 0,5 °C.  
Floor temperature sensor: NTC, 10KΩ at 25°C, -40°C to 80°C. Double isolated cable, 4m length.  
LED light indication: Red and green.  
Ambient temperature: -20 °C to 45 °C.  
Without fixing claws.  
Cover plate code: 8540.9.

**8140.9** 2CLA814090A1001 1

















**Cover plate with rotatory knob for RTC**  
Cover plate for room thermostat code: 8140.9.

Soft White	<b>8540.9 BL</b>	2CLA854090A1101	5
Silver	<b>8540.9 PL</b>	2CLA854090A1301	5
Soft Black	<b>8540.9 NS</b>	2CLA854090A1501	5
Stainless Steel	<b>8540.9 AI</b>	2CLA854090A1401	5
Antique Gold	<b>8540.9 OE</b>	2CLA854090A1201	5

## Sky Niessen



### Signaling and lighting systems

Product	Article-No.	Order-No.	Pack/Qty
	<b>LED signaling light</b> Rated voltage: 127-230 Vac / 50-60 Hz Lamp: white LED Luminous flux: > 2 lumen at 1 meter White diffuser Without fixing claws Cover plate code: 8581 without pictogram or 8581.XX with pictogram.		
	<b>8180.1</b>	2CLA818010A1001	1
	<b>LED DND/MUR signaling light</b> Rated voltage: 127-230 Vac / 50-60 Hz. Lamp: red/green LED. Luminous flux: > 2 lumen at 1 meter. White diffuser. Without fixing claws. Cover plate code: 8581 without pictogram or 8581.XX with pictogram.		
	<b>8180.2</b>	2CLA818020A1001	1
	<b>Beacon LED light</b> Rated voltage: 230 Vac / 50 Hz. Lamp: white LED. Luminous flux: > 2 lumen at 1 meter. White diffuser. Autonomy: 3 hours (1 hour at maximum illumination 2 hours with lower illumination). Battery: Ni-MH (estimated lifetime: 4 years). Without fixing claws. Cover plate code: 8581 without pictogram or 8581.XX with pictogram.		
	<b>8181.2</b>	2CLA818120A1001	1
	<b>Cover for signaling light white</b> Cover for signaling light with white diffuser for LED lights code: 8180.1, 8180.2 & 8181.2.		
	<b>8581 BL</b>	2CLA858100A1101	5
	<b>Cover for signaling light red</b> Cover for signaling light with red diffuser for LED lights code: 8180.1, 8180.2 & 8181.3.		
	<b>8581 RJ</b>	2CLA858100A1301	5
	<b>Cover for signaling light green</b> Cover for signaling light with green diffuser for LED lights code: 8180.1, 8180.2 & 8181.4.		
	<b>8581 VD</b>	2CLA858100A1401	5
	<b>Cover for signaling light "WC" symbol</b> Cover for signaling light with white diffuser and "WC" symbol for LED lights code: 8180.1, 8180.2 & 8181.5.		
	<b>8581.10</b>	2CLA858110A1001	5



Product	Article-No.	Order-No.	Pack/Qty
	<b>Cover for signaling light "WC men" symbol</b> Cover for signaling light with white diffuser and "WC men" symbol for LED lights code: 8180.1, 8180.2 & 8181.5.		
	<b>8581.11</b>	2CLA858110A1101	5
	<b>Cover for signaling light "WC women" symbol</b> Cover for signaling light with white diffuser and "WC woman" symbol for LED lights code: 8180.1, 8180.2 & 8181.5.		
	<b>8581.12</b>	2CLA858110A1201	5
	<b>Cover for signaling light "WC handic." symbol</b> Cover for signaling light with white diffuser and "WC handic." symbol for LED lights code: 8180.1, 8180.2 & 8181.5.		
	<b>8581.13</b>	2CLA858110A1301	5
	<b>Cover for signaling light "No smoking" symbol</b> Cover for signaling light with white diffuser and "No smoking" symbol for LED lights code: 8180.1, 8180.2 & 8181.5.		
	<b>8581.14</b>	2CLA858110A1401	5
	<b>Cover for signaling light "No phone" symbol</b> Cover for signaling light with white diffuser and "No phone" symbol for LED lights code: 8180.1, 8180.2 & 8181.5.		
	<b>8581.15</b>	2CLA858110A1501	5
	<b>Cover for signaling light "Silence" symbol</b> Cover for signaling light with white diffuser and "Silence". symbol for LED lights code: 8180.1, 8180.2 & 8181.5.		
	<b>8581.16</b>	2CLA858110A1601	5
	<b>Cover for signaling light "Silence" symbol</b> Cover for signaling light with white diffuser and "Silence". symbol for LED lights code: 8180.1, 8180.2 & 8181.5.		
	<b>8581.17</b>	2CLA858110A1701	5
	<b>Cover for signaling light "No entry" symbol</b> Cover for signaling light with white diffuser and "No entry". symbol for LED lights code: 8180.1, 8180.2 & 8181.5.		
	<b>8581.18</b>	2CLA858110A1801	5

## Sky Niessen

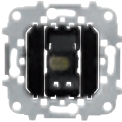

### Signaling and lighting systems

Product	Article-No.	Order-No.	Pack/Qty
	<b>Cover for signaling light "Elevator" symbol</b> Cover for signaling light with white diffuser and "Elevator" symbol for LED lights code: 8180.1, 8180.2 & 8181.5.		
	<b>8581.19</b>	2CLA858110A1901	5
	<b>Cover for signaling light "Exit" symbol</b> Cover for signaling light with white diffuser and "Exit" symbol for LED lights code: 8180.1, 8180.2 & 8181.5.		
	<b>8581.20</b>	2CLA858120A1001	5
	<b>Cover for signaling light "Info point" symbol</b> Cover for signaling light with white diffuser and "Info point" symbol for LED lights code: 8180.1, 8180.2 & 8181.5.		
	<b>8581.21</b>	2CLA858120A1101	5

### Buzzer / Door bell

Product	Article-No.	Order-No.	Pack/Qty
	<b>Buzzer</b> Rated voltage: 127 - 230 Vac / 50 - 60 Hz. Rated power: 8 VA. Adjustable tone. Acoustic power at 1 meter with cover plate: 75 dB. Without fixing claws. Cover plate code: 8529.		
	<b>8119</b>	2CLA811900A1001	10
	<b>Electronic door bell with 4 melodies</b> Rated voltage: 230 Vac / 50-60 Hz. 4 melodies available. Acoustic power at 1 meter with cover plate: 72 dB. Without fixing claws. Cover plate code: 8529.		
	<b>8124.2</b>	2CLA812420A1001	1
	<b>Cover plate for buzzer/door bell</b> Cover plate for buzzer / door bell code: 8119 & 8124.2.		
Soft White	<b>8529 BL</b>	2CLA852900A1101	5
Silver	<b>8529 PL</b>	2CLA852900A1301	5
Soft Black	<b>8529 NS</b>	2CLA852900A1501	5
Stainless Steel	<b>8529 AI</b>	2CLA852900A1401	5
Antique Gold	<b>8529 OE</b>	2CLA852900A1201	5

### Blank covers / Cable outlets

Product	Article-No.	Order-No.	Pack/Qty
	<b>Blank cover plate</b> Included: mounting grid and cover plate. Without fixing claws.		
Soft White	<b>8500 BL</b>	2CLA850000A1101	10
Silver	<b>8500 PL</b>	2CLA850000A1301	10
Soft Black	<b>8500 NS</b>	2CLA850000A1501	10
Stainless Steel	<b>8500 AI</b>	2CLA850000A1401	10
Antique Gold	<b>8500 OE</b>	2CLA850000A1201	10
	<b>Cable outlet</b> 3 connection screw terminals up to 2,5 mm <sup>2</sup> . Cable tie included. Included: fixing claws. Cover plate code: 8507.		
	<b>8107</b>	2CLA810700A1001	10
	<b>Cover plate for cable outlet</b> Cover plate for cable outlet code: 8107.		
Soft White	<b>8507 BL</b>	2CLA850700A1101	10
Silver	<b>8507 PL</b>	2CLA850700A1301	10
Soft Black	<b>8507 NS</b>	2CLA850700A1501	10
Stainless Steel	<b>8507 AI</b>	2CLA850700A1401	10
Antique Gold	<b>8507 OE</b>	2CLA850700A1201	10

## Sky Niessen - Frames



Soft  
White  
frame



Soft  
White  
Basic  
frame



01



04



07



02



05



08



03



06



09

---

### Sky Niessen Soft

01 Soft White

02 Silver

03 Soft Black

---

### Sky Niessen Steel

04 Stainless steel

05 Antique Gold

---

### Sky Niessen Wood

06 Ash

07 Natural Wenge

---

### Sky Niessen Glass

08 White Glass

09 Black Glass



## Sky Niessen - Frames

### Soft White

Product	Article-No.	Order-No.	Pack/Qty	
 <p><b>Frames 1 to 5-gang - Soft White</b>                      Size (height x width):                      - 1-gang: 86 x 86 mm.                      - 2-gang: 86 x 157 mm.                      - 3-gang: 86 x 228 mm.                      - 4-gang: 86 x 299 mm.                      - 5-gang: 86 x 370 mm.                      Flush mounting boxes code: 1099, 1999 &amp; 1999.2.                      Surface mounting boxes code: 8591, 8592 &amp; 8593.</p>	1-gang	<b>8571 BL</b>	2CLA857100A1101	20
	2-gang	<b>8572 BL</b>	2CLA857200A1101	20
	3-gang	<b>8573 BL</b>	2CLA857300A1101	10
	4-gang	<b>8574 BL</b>	2CLA857400A1101	5
	5-gang	<b>8575 BL</b>	2CLA857500A1101	5

### Silver

Product	Article-No.	Order-No.	Pack/Qty	
 <p><b>Frames 1 to 5-gang - Silver</b>                      Size (height x width):                      - 1-gang: 86 x 86 mm.                      - 2-gang: 86 x 157 mm.                      - 3-gang: 86 x 228 mm.                      - 4-gang: 86 x 299 mm.                      - 5-gang: 86 x 370 mm.                      Flush mounting boxes code: 1099, 1999 &amp; 1999.2.                      Surface mounting boxes code: 8591, 8592 &amp; 8593.</p>	1-gang	<b>8571 PL</b>	2CLA857100A1301	20
	2-gang	<b>8572 PL</b>	2CLA857200A1301	20
	3-gang	<b>8573 PL</b>	2CLA857300A1301	10
	4-gang	<b>8574 PL</b>	2CLA857400A1301	5

### Soft White - Basic

Product	Article-No.	Order-No.	Pack/Qty	
 <p><b>Frames 1 to 4-gang - Basic - Soft White</b>                      Size (height x width):                      - 1-gang: 86 x 86 mm.                      - 2-gang: 86 x 157 mm.                      - 3-gang: 86 x 228 mm.                      - 4-gang: 86 x 299 mm.                      Flush mounting boxes code: 1099, 1999 &amp; 1999.2.                      Surface mounting boxes code: 8591, 8592 &amp; 8593.</p>	1-gang	<b>8571.1 BL</b>	2CLA857110A1101	20
	2-gang	<b>8572.1 BL</b>	2CLA857210A1101	20
	3-gang	<b>8573.1 BL</b>	2CLA857310A1101	10
	4-gang	<b>8574.1 BL</b>	2CLA857410A1101	5

### Soft Black

Product	Article-No.	Order-No.	Pack/Qty	
 <p><b>Frames 1 to 5-gang - Soft Black</b>                      Size (height x width):                      - 1-gang: 86 x 86 mm.                      - 2-gang: 86 x 157 mm.                      - 3-gang: 86 x 228 mm.                      - 4-gang: 86 x 299 mm.                      - 5-gang: 86 x 370 mm.                      Flush mounting boxes code: 1099, 1999 &amp; 1999.2.                      Surface mounting boxes code: 8591, 8592 &amp; 8593.</p>	1-gang	<b>8571 NS</b>	2CLA857100A1501	20
	2-gang	<b>8572 NS</b>	2CLA857200A1501	20
	3-gang	<b>8573 NS</b>	2CLA857300A1501	10
	4-gang	<b>8574 NS</b>	2CLA857400A1501	5

## Sky Niessen - Frames

### Stainless Steel

Product	Article-No.	Order-No.	Pack/Qty
	<b>Frames 1 to 4-gang - Noble - Stainless Steel</b> Material: anti-fingerprint stainless steel. Size (height x width): - 1-gang: 86 x 86 mm. - 2-gang: 86 x 157 mm. - 3-gang: 86 x 228 mm. - 4-gang: 86 x 299 mm. Flush mounting boxes code: 1099, 1999 & 1999.2. Surface mounting boxes code: 8591, 8592 & 8593.		
1-gang	<b>8571 AI</b>	2CLA857100A1401	10
2-gang	<b>8572 AI</b>	2CLA857200A1401	10
3-gang	<b>8573 AI</b>	2CLA857300A1401	10
4-gang	<b>8574 AI</b>	2CLA857400A1401	5

### Antique Gold

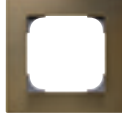
Product	Article-No.	Order-No.	Pack/Qty
	<b>Frames 1 to 4-gang - Noble - Antique Gold</b> Material: stainless steel. Size (height x width): - 1-gang: 86 x 86 mm. - 2-gang: 86 x 157 mm. - 3-gang: 86 x 228 mm. - 4-gang: 86 x 299 mm. Flush mounting boxes code: 1099, 1999 & 1999.2. Surface mounting boxes code: 8591, 8592 & 8593.		
1-gang	<b>8571 OE</b>	2CLA857100A1201	10
2-gang	<b>8572 OE</b>	2CLA857200A1201	10
3-gang	<b>8573 OE</b>	2CLA857300A1201	10
4-gang	<b>8574 OE</b>	2CLA857400A1201	5

### Ash

Product	Article-No.	Order-No.	Pack/Qty
	<b>Frames 1 to 4-gang - Noble - Ash</b> Material: wood. Size (height x width): - 1-gang: 86 x 86 mm. - 2-gang: 86 x 157 mm. - 3-gang: 86 x 228 mm. - 4-gang: 86 x 299 mm. Flush mounting boxes code: 1099, 1999 & 1999.2. Surface mounting boxes code: 8591, 8592 & 8593.		
1-gang	<b>8571 FR</b>	2CLA857100A2001	1
2-gang	<b>8572 FR</b>	2CLA857200A2001	1
3-gang	<b>8573 FR</b>	2CLA857300A2001	1
4-gang	<b>8574 FR</b>	2CLA857400A2001	1

### Natural Wenge

Product	Article-No.	Order-No.	Pack/Qty
	<b>Frames 1 to 4-gang - Noble - Natural Wengué</b> Material: wood. Size (height x width): - 1-gang: 86 x 86 mm. - 2-gang: 86 x 157 mm. - 3-gang: 86 x 228 mm. - 4-gang: 86 x 299 mm. Flush mounting boxes code: 1099, 1999 & 1999.2. Surface mounting boxes code: 8591, 8592 & 8593.		
1-gang	<b>8571 WN</b>	2CLA857100A2101	1
2-gang	<b>8572 WN</b>	2CLA857200A2101	1
3-gang	<b>8573 WN</b>	2CLA857300A2101	1
4-gang	<b>8574 WN</b>	2CLA857400A2101	1

### White Glass



Product	Article-No.	Order-No.	Pack/Qty
	<b>Frames 1 to 4-gang - Noble - White Glass</b> Material: glass. Size (height x width): - 1-gang: 86 x 86 mm. - 2-gang: 86 x 157 mm. - 3-gang: 86 x 228 mm. - 4-gang: 86 x 299 mm. Flush mounting boxes code: 1099, 1999 & 1999.2. Surface mounting boxes code: 8591, 8592 & 8593.		
1-gang	<b>8571 CB</b>	2CLA857100A3001	1
2-gang	<b>8572 CB</b>	2CLA857200A3001	1
3-gang	<b>8573 CB</b>	2CLA857300A3001	1
4-gang	<b>8574 CB</b>	2CLA857400A3001	1

### Black Glass



Product	Article-No.	Order-No.	Pack/Qty
	<b>Frames 1 to 4-gang - Noble - Black Glass</b> Material: glass. Size (height x width): - 1-gang: 86 x 86 mm. - 2-gang: 86 x 157 mm. - 3-gang: 86 x 228 mm. - 4-gang: 86 x 299 mm. Flush mounting boxes code: 1099, 1999 & 1999.2. Surface mounting boxes code: 8591, 8592 & 8593.		
1-gang	<b>8571 CN</b>	2CLA857100A3101	1
2-gang	<b>8572 CN</b>	2CLA857200A3101	1
3-gang	<b>8573 CN</b>	2CLA857300A3101	1
4-gang	<b>8574 CN</b>	2CLA857400A3101	1

## Sky Niessen - Installation solutions

### Surface mounting boxes

Product	Article-No.	Order-No.	Pack/Qty
	<b>Surface mounting box 1-gang</b> Size (height x width x depth): 86 x 86 x 43 mm.		
White	<b>8591 BL</b>	2CLA859100A1101	6
	<b>Surface mounting box 2-gang</b> Size (height x width x depth): 86 x 157 x 43 mm.		
White	<b>8592 BL</b>	2CLA859200A1101	5
	<b>Surface mounting box 3-gang</b> Size (height x width x depth): 86 x 228 x 43 mm.		
White	<b>8593 BL</b>	2CLA859300A1101	1

### Flush mounting boxes

Product	Article-No.	Order-No.	Pack/Qty
	<b>Flush mounting box - Bricks and cement</b> Installation box for walls built with bricks or cement. Distance between screws: 60 mm. Suitable for mounting plates code: N2271.9, N2271.9G & N2272.9. Allows the input of 2 tubes per each side. Linkable for multigang frames. Included: 2 screws to fix the mounting plate. The screws can be placed in any of the 4 sides to facilitate the installation of the insert in vertical and horizontal.		
	<b>1099</b>	2CLA009900A1001	50
	<b>Flush mounting box - Drywall and partitions</b> Installation box for walls built with drywall or partitions. Distance between screws: 60 mm. Suitable for mounting plates code: N2271.9, N2271.9G & N2272.9. Linkable for multigang frames. Included: 2 screws to fix the mounting plate. Shaft diameter: 68 mm.		
	<b>999</b>	2CLA099909A1001	25
	<b>Flush mounting box - Drywall and partitions</b> Double box suitable for 2-gang mounting plates. Installation box for walls built with drywall or partitions. Distance between screws: 60 mm Suitable for mounting plates code: N2271.9, N2271.9G & N2272.9. Included: 4 screws to fix the mounting plate. Shaft diameter: 68 mm. Distance between centers: 71 mm.		
	<b>999.2</b>	2CLA099920A1001	10

# Skymoon

## Table of codes

### Mechanism

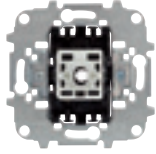

### Keys and covers

Chrome (CR)

Black Glass (CN)



### Colours XX

### Keys and covers

CR Chrome

CN Black Glass

### Frames

White Glass (CB)

Black Glass (CN)



Stainless Steel (OX)



### Colours XX

### Frames

CB White Glass

CN Black Glass

OX Stainless steel

Sky Niessen Glass	Article No.	Color	Pack (unit)
1 element	8671	XX	1
2 elements	8672	XX	1
4 elements	8673	XX	1

Sky Niessen Steel	Article No.	Color	Pack (unit)
1 element	8671	XX	1
2 elements	8672	XX	1
4 elements	8673	XX	1

Insert description	Article No.	Pack (unit)	Description	Article No.	Color	Pack (unit)
<b>1-way switches</b>			<b>Rockers for switches and push-buttons</b>			
Switch 1-gang, 1-way, single pole	8101	10	Rocker for switch, 1-gang	8601	XX	5
<b>2-way switches</b>			Rocker for switch, 1-gang	8601.3	XX	5
Switch 1-gang, 2-way, single pole	8102	10				
Switch 1-gang, 2-way, single pole 16A	8102.1	10				
<b>Intermediate switches</b>						
Switch 1-gang, intermediate, single pole	8110	10				
<b>Switches with indicator lamp</b>			<b>Cover plate</b>			
Switch 1-gang, 1-way, single pole	8101.5	10				
Switch 1-gang, 2-way, single pole	8102.5	10				
<b>Push-buttons</b>			<b>Cover plate</b>			
Push-button 1-gang, single pole, NO	8104	10				
Push-button 1-gang, SP, NO w/ locator lamp	8104.5	10				
Push-button 1-gang, single pole, NC	8104.9	5				
<b>Indicator / locator LED lamp</b>						
Indicator/locator LED lamp 230Vac				6192	BL	10
<b>2-gang switches &amp; push-buttons</b>			<b>Cover plates</b>			
Switch 2-gangs, 1-way, single pole	8111	10	Rocker for switch/ push-button, 2-gangs	8611	XX	5
Switch 2-gangs, 2-way, single pole	8122	10				
Push-button 2-gangs, single pole, NO	8144.2	10				
Switch 2-way + push-button 1-way NO, SP	8142	10				
<b>Pullcord switches</b>			<b>Cover plates</b>			
Pullcord switch 1-gang, 1-way, single pole	8148	5	Cover for pull cord switch	8607	XX	5
<b>Blind controls</b>			<b>Cover plates</b>			
Push-button blind control 2-gangs	8144	10	Rocker for blind switch/ push-button	8644	XX	5
Switch blind control 2-gangs	8144.1	10				
Electronic blind control 1-gang	8630.3	1				
<b>Schuko socket outlets</b>			<b>Cover plate</b>			
Schuko socket outlet for plain covers	8188.9	10	Flat cover plate for Schuko socket outlet	8688.9	XX	5
<b>French / earth-pin socket outlets</b>			<b>Cover plate</b>			
French/Earth-pin socket outlet for plain covers	8187.9	10	Flat cover plate for French socket outlet	8687.9	XX	5
<b>USB chargers</b>			<b>Cover plate</b>			
USB charger 1.500mA, 2 outlets	8185	1	Cover plate for USB charger 1,5 A	8685	XX	5
<b>TV outlets</b>			<b>Cover plate</b>			
TV / R terminal outlet	8150	10	Cover plate for TV/R/SAT outlet	8650	XX	20
TV / R final outlet - CATV outlet	8150.3	10				
TV / R loop-through outlet	8150.7	10				
TV-R/SAT terminal outlet	8151.3	10				
TV-R/SAT final outlet	8151.7	10				
TV-R/SAT loop-through outlet	8151.8	10				
<b>Telephone &amp; data outlets</b>			<b>Cover plates</b>			
Telephone outlet RJ12	2017.2	10	Cover plate for data outlet 1-gang	8618.1	XX	2
Telephone outlet RJ45 Cat.3	2017.3	10				
Data outlet RJ45 Cat.5e UTP	2018.5	10	Cover plate for data outlet 2-gangs	8618.2	XX	2
Data outlet RJ45 Cat.6 UTP	2018.6	10				
Data outlet RJ45 Cat.6A STP	2018.7	10				
Housing for data outlets - Keystone type	2018	10				
Housing for data outlets - Systimax type	2018.8	10				
<b>Light controls - Rotatory dimmers</b>			<b>Cover plate</b>			
Universal rotatory/push dimmer	8660	1				
LED rotatory/push dimmer	8660.2	1				
1-10V rotatory dimmer	8660.9	1				
<b>Buzzer / Door bell</b>			<b>Cover plate</b>			
Buzzer	8119	10	Cover plate for buzzer/ door bell	8629	XX	5
Electronic door bell with 4 melodies	8124.2	1				
<b>Blank covers / Cable outlets</b>			<b>Cover plates</b>			
			Blank cover plate	8600	XX	2
Cable outlet	8107	10	Cover plate for cable outlet	8607	XX	5



# Skymoon line

Skymoon is the ultimate expression of design, with unique class and subtlety. Its innovative design presents technical solutions never seen before. Elegant materials, machined metallic keys, 6mm high with respect to the wall... With the Skymoon line you will achieve that distinctive touch that makes a room a unique space. Its avant-garde design will mean that all eyes will be drawn to the most attractive item in your home or business.

## Switch composition



Insert

Frame

Rocker

## Socket composition



Insert

Frame

Cover

### Characteristics

- 250 V~
- 10 AX / 16 AX
- IP21
- CE Compliance Declaration pursuant to:
  - Low Voltage Directive 2006/95/CE
  - European Directive RoHS 2011/65/EU
  - IEC 60669-1
  - UNE-EN 60669-1
  - UNE 20324-REBT-BT27 - IP21
- AENOR certified product pursuant to:
  - UNE-EN 60669-1
  - UNE-EN 60669-1/A1
  - UNE-EN 60669-1/A2

### Characteristics

- 250 V~
- 16 A
- IP21
- Compliant with standards:
  - European Directive RoHS 2011/65/EU
  - IEC 60884-1
  - UNE-EN 20315
  - UNE 20324-REBT-BT27 - IP21
- AENOR certified product pursuant to:
  - UNE 20315-1-1

## Sky Niessen

### 1-way switches

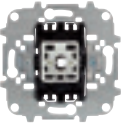
Product	Article-No.	Order-No.	Pack/Qty
	<b>Switch 1-gang, 1-way, single pole</b> Rated voltage: 110 - 250 Vac. Rated current: 10 AX. Screwless terminals. Included: fixing claws. Optional: locator LED lamp 6192 BL (230 Vac). Rocker code: 8601, & 8601.3.		
	<b>8101</b>	2CLA810100A1001	10

### 2-way switches

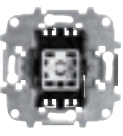
Product	Article-No.	Order-No.	Pack/Qty
	<b>Switch 1-gang, 2-way, single pole</b> Rated voltage: 110 - 250 Vac. Rated current: 10 AX. Screwless terminals. Included: fixing claws. Optional: locator LED lamp 6192 BL (230 Vac). Rocker code: 8601 & 8601.3.		
	<b>8102</b>	2CLA810200A1001	10

	<b>Switch 1-gang, 2-way, single pole 16A</b> Rated voltage: 110 - 250 Vac. Rated current: 16 AX. Screwless terminals. Included: fixing claws. Optional: locator LED lamp 6192 BL (230 Vac). Rocker code: 8601 & 8601.3.		
	<b>8102.1</b>	2CLA810210A1001	10

### Intermediate switches

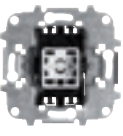
Product	Article-No.	Order-No.	Pack/Qty
	<b>Switch 1-gang, intermediate, single pole</b> Rated voltage: 110 - 250 Vac. Rated current: 10 AX. Screwless terminals. Included: fixing claws. Optional: locator LED lamp 6192 BL (230 Vac). Rocker code: 8601 & 8601.3.		
	<b>8110</b>	2CLA811000A1001	10

### Switches with indicator lamp

Product	Article-No.	Order-No.	Pack/Qty
	<b>Switch 1-gang, 1-way, single pole</b> Rated voltage: 110 - 250 Vac. Rated current: 10 AX. Screwless terminals. Included: fixing claws. 3 wire connection (neutral conductor required). Included: indicator LED lamp 6192 BL (230 Vac). Rocker code: 8601.3.		
	<b>8101.5</b>	2CLA810150A1001	10

	<b>Switch 1-gang, 2-way, single pole</b> Rated voltage: 110 - 250 Vac. Rated current: 10 AX. Screwless terminals. Included: fixing claws. 4 wire connection (neutral conductor required). Indicator: indicator LED lamp 6192 BL (230 Vac). Rocker code: 8601.3.		
	<b>8102.5</b>	2CLA810250A1001	10

### Push-buttons

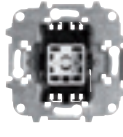
Product	Article-No.	Order-No.	Pack/Qty
	<b>Push-button 1-gang, single pole, NO</b> Rated voltage: 110 - 250 Vac. Rated current: 10 AX. NO: Normally Open. Screwless terminals. Included: fixing claws. Optional: locator LED lamp 6192 BL (230 Vac). Rocker code: 8601 & 8601.3.		
	<b>8104</b>	2CLA810400A1001	10

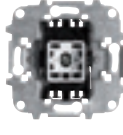
	<b>Push-button 1-gang, SP, NO w/ locator lamp</b> Rated voltage: 110 - 250 Vac. Rated current: 10 AX. NO: Normally Open. Screwless terminals. Included: fixing claws. 3 wire connection (neutral conductor required). Included: locator LED lamp 6192 BL (230 Vac). Rocker code: 8601.3.		
	<b>8104.5</b>	2CLA810450A1001	10

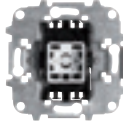
	<b>Push-button 1-gang, single pole, NC</b> Rated voltage: 110 - 250 Vac. Rated current: 10AX. NC: normally closed. Screwless terminals. Included: fixing claws. Optional: locator LED lamp 6192 BL (230 Vac). Rocker code: 8601 & 8601.3.		
	<b>8104.9</b>	2CLA810490A1001	5

### Rockers for switches and push-buttons

Product	Article-No.	Order-No.	Pack/Qty
	<b>Rocker for switch, 1-gang</b> Rocker for switches code: 8101, 8102, 8102.1 & 8110.		
Chrome	<b>8601 CR</b>	2CLA860100A1401	5
Black Glass	<b>8601 CN</b>	2CLA860100A1501	5





	<b>Rocker for switch, 1-gang</b> Rocker for switches code: 8101, 8102, 8102.1 & 8110.		
Chrome	<b>8601.3 CR</b>	2CLA860130A1401	5
Black Glass	<b>8601.3 CN</b>	2CLA860130A1501	5

### Indicator / locator LED lamp

Product	Article-No.	Order-No.	Pack/Qty
	<b>Indicator/locator LED lamp 230Vac</b> For 81XX inserts. Lamp: white LED. Long life cycle. Two functions: indicator or locator light. Power consumption: 0,2 mA. Especially recommended for LED and energy saving lamps.		
Soft White	<b>6192 BL</b>	2CLA819202A1001	10

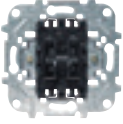

## Sky Niessen

### 2-gang switches & push-buttons



Product	Article-No.	Order-No.	Pack/Qty
	<b>Switch 2-gangs, 1-way, single pole</b> Rated voltage: 110 - 250 Vac. Rated current: 10 AX. Screwless terminals. Included: fixing claws. Rocker code: 8611.		
	<b>8111</b>	2CLA811100A1001	10
	<b>Switch 2-gangs, 2-way, single pole</b> Rated voltage: 110 - 250 Vac. Rated current: 10 AX. Screwless terminals. Included: fixing claws. Rocker code: 8611.		
	<b>8122</b>	2CLA812200A1001	10
	<b>Push-button 2-gangs, single pole, NO</b> Rated voltage: 110 - 250 Vac. Rated current: 10 AX. Screwless terminals. Without interlock. Included: fixing claws. Rocker code: 8611.		
	<b>8144.2</b>	2CLA814420A1001	10
	<b>Switch 2-way + push-button 1-way NO, SP</b> Rated voltage: 110 - 250 Vac. Rated current: 10 AX. Screwless terminals. Included: fixing claws. Rocker code: 8611.		
	<b>8142</b>	2CLA814200A1001	10
	<b>Rocker for switch/push-button, 2-gangs</b> Rocker for switch/push-buttons code: 8111, 8122, 8144.2 & 8142.		
Chrome	<b>8611 CR</b>	2CLA861100A1401	5
Black Glass	<b>8611 CN</b>	2CLA861100A1501	5

## Sky Niessen

### Pullcord switches

Product	Article-No.	Order-No.	Pack/Qty
	<b>Pullcord switch 1-gang, 1-way, single pole</b> Rated voltage: 110 - 250 Vac. Rated current: 16 A. Screwless terminals. Included: fixing claws. Cord length: 2 meters. Cover plate code: 8607.		
	<b>8148</b>	2CLA814800A1001	5
	<b>Cover for pull cord switch</b> Cover plate for pullcord switch code: 8148.		
Chrome	<b>8607 CR</b>	2CLA860700A1401	5
Black Glass	<b>8607 CN</b>	2CLA860700A1501	5

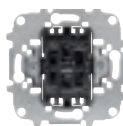
### Blind controls

Product	Article-No.	Order-No.	Pack/Qty
	<b>Push-button blind control 2-gangs</b> Rated voltage: 110 - 250 Vac. Rated current: 10 AX. Direct control. Interlocked gangs. Included: fixing claws. Rocker code: 8644.		
	<b>8144</b>	2CLA814400A1001	10
	<b>Switch blind control 2-gangs</b> Rated voltage: 110 - 250 Vac. Rated current: 10 AX. Direct control. Interlocked gangs. Included: fixing claws. Rocker code: 8644.		
	<b>8144.1</b>	2CLA814410A1001	10
	<b>Rocker for blind switch/push-button</b> Rocker for blind switch/push-button code: 8144 & 8144.1.		
Chrome	<b>8644 CR</b>	2CLA864400A1401	5
Black Glass	<b>8644 CN</b>	2CLA864400A1501	5
	<b>Electronic blind control 1-gang</b> Rated voltage: 110 - 250 Vac ; 50 / 60 Hz. Rated current: 700VA@230Vac / 350VA@127Vac. Direct control. Functions: - PERS: standard blinds control. Optionally other 8144 inserts can be connected to the 8630.3 to control the blind from other locations. - LAM: venetian type blinds control. Optionally other 8144 inserts can be connected to the 8630.3 to control the blind from other locations. - Centralization (CEN): one 8630.3 can control all the 8630.3 of a line centrally. Without fixing claws.		
Chrome	<b>8630.3 CR</b>	2CLA863030A1401	1
Black Glass	<b>8630.3 CN</b>	2CLA863030A1501	1

## Sky Niessen

### Schuko socket outlets

Product	Article-No.	Order-No.	Pack/Qty
 <p><b>Schuko socket outlet for plain covers</b>            Rated voltage: 250 Vac.            Rated current: 16 A.            Type F: 2P + E.            Shuttered for child safety.            Screw terminals.            Without fixing claws.            Cover plate code: 8688.9.</p>	<b>8188.9</b>	2CLA818890A1001	10



**Flat cover plate for Schuko socket outlet**  
 Cover plate for Schuko socket outlet code: 8188.9.

Chrome	<b>8688.9 CR</b>	2CLA868890A1401	5
Black Glass	<b>8688.9 CN</b>	2CLA868890A1501	5

### French / earth-pin socket outlets

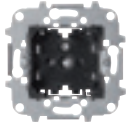
Product	Article-No.	Order-No.	Pack/Qty
 <p><b>French/Earth-pin socket outlet for plain covers</b>            Rated voltage: 250 Vac.            Rated current: 16 A.            Type E: 2P + E.            Shuttered for child safety.            Screwless terminals.            Included: fixing claws.            Cover plate code: 8687.9.</p>	<b>8187.9</b>	2CLA818790A1001	10



**Flat cover plate for French socket outlet**  
 Cover plate for Schuko socket outlet code: 8187.9.

Chrome	<b>8687.9 CR</b>	2CLA868790A1401	5
Black Glass	<b>8687.9 CN</b>	2CLA868790A1501	5

### USB chargers

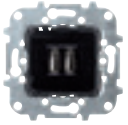
Product	Article-No.	Order-No.	Pack/Qty
 <p><b>USB charger 1.500mA, 2 outlets</b>            Input voltage: 100 - 240 Vac <math>\pm</math>10% ; 50 / 60 Hz.            Input current: 0,20 A (with maximum load).            Output voltage: 5 Vdc <math>\pm</math>5%.            Output current: 1.500 mA (total for both gangs).            Power consumption in stand-by: <math>\leq</math> 0,3W@230Vac.            Energy efficiency: <math>\geq</math> 71%.            Operating temperature: 0 °C to 35 °C.            Mounting grid delivered with the cover plate            (without fixing claws).            Cover plate code: 8685.</p>	<b>8185</b>	2CLA818500A1001	1





**Cover plate for USB charger 1,5A**  
 Cover plate for USB charger code: 8185.





Chrome	<b>8685 CR</b>	2CLA868500A1401	5
Black Glass	<b>8685 CN</b>	2CLA868500A1501	5



# Sky Niessen

## TV outlets

Product	Article-No.	Order-No.	Pack/Qty
 <p><b>TV / R terminal outlet</b> TV and R double outlet - Final. Without filter. Installation as a terminal outlet connected to a tap-off or splitter (without terminal resistor). Connection: screw terminal and clamp. Output connectors (C1 / C2): IEC male 9,52mm diam. / IEC female 9,52 mm. diam. Frequency range (I/O / C1 / C2): 5 - 862 MHz / 5 - 862 MHz / 5 - 862 MHz. Basic loss (FM / DAB / VHF / UHF): 10,0±0,7 dB / 10,0 ±1,5 dB / 4,0±1,5 dB / 3,0±0,5 dB. Isolation (FM / TV): &gt;14 / &gt;14. Return loss (FM / TV): &gt;18 / &gt;10. Included: fixing claws. Cover plate code: 8650.</p>	<b>8150</b>	2CLA815000A1001	10
 <p><b>TV / R final outlet - CATV outlet</b> TV and R double outlet - CATV outlet - Final. With filter. Installation as a terminal outlet connected to a tap-off or splitter (without terminal resistor). Connection: screw terminal and clamp. Output connectors (C1 / C2): IEC male 9,52 mm. diam. / IEC female 9,52 mm. diam. Frequency range (C1 / C2): 5 - 68 &amp; 118 - 1.000 MHz / 87,5 - 108 MHz. Basic loss (R / FM / TV): 0,3±0,1 dB / 1,1 ±0,3 dB / 0,9±0,3 dB. Isolation (FM / TV): &gt;18 / &gt;16. Selectivity (FM / TV): &gt;10 / &gt;18. Return loss (R / FM / TV): &gt;18 / &gt;16 / &gt;18. Chroma-luminance delay (ns): &lt;10. Included: fixing claws. Cover plate code: 8650.</p>	<b>8150.3</b>	2CLA815030A1001	10
 <p><b>TV / R loop-through outlet</b> TV and R double outlet - Intermediate. Installation as an intermediate outlet in series connected to each other. From 2nd to 4th floor. Connection: screw terminal and clamp. Output connectors (C1 / C2): IEC male 9,52mm diam. / IEC female 9,52 mm. diam. Frequency range (I/O / C1 / C2): 13 - 862 MHz / 13 - 862 MHz / 13 - 862 MHz. Basic loss (FM / DAB / VHF / UHF): 25±1,5 dB / 25 ±1,5 dB / 8,0±0,7 dB / 8,0±0,7 dB. Through loss (FM / VHF / UHF): 2,0±0,3 dB / 2,0±0,5 dB / 2,0±0,5 dB. Directivity (FM / TV): &gt;12 dB / &gt;9 dB. Isolation (FM / TV): &gt;16 / &gt;15. Return loss (FM / TV): &gt;12 / &gt;12. Included: fixing claws. Cover plate code: 8650.</p>	<b>8150.7</b>	2CLA815070A1001	10

Product	Article-No.	Order-No.	Pack/Qty
 <p><b>TV-R/SAT terminal outlet</b> TV-R and SAT double outlet - Final. Installation as a terminal outlet connected to a tap-off or splitter (without terminal resistor). Connection: screw terminal and clamp. Output connectors (C1 / C2): IEC male 9,52 mm. diam. / IEC female 9,52 mm. diam. Frequency range (I/O / C1 / C2): 5 - 2.400 MHz / 5 - 862 MHz / 930 - 2.400 MHz. Basic loss (FM / TV / SAT): 0,2±0,1 dB / 1,0 ±0,5 dB / 1,2±0,6 dB. Isolation (FM / TV / SAT): &gt;45 / &gt;14 / &gt;14. Selectivity (TV-R / SAT): &gt;15 / &gt;15. Return loss (VR / FM / TV / SAT): &gt;25 / &gt;25 / &gt;14 / &gt;10. DC path (Vdc / mA / Tono): 24 max. / 500 max. / 22 KHz - DiSEqC. Included: fixing claws. Cover plate code: 8650.</p>	<b>8151.3</b>	2CLA815130A1001	10
 <p><b>TV-R/SAT final outlet</b> TV-R and SAT double outlet - Final. Installation as a terminal outlet connected to a series with loop-through outlets. Connection: screw terminal and clamp. Output connectors (C1 / C2): IEC male 9,52 mm. diam. / IEC female 9,52 mm. diam. Frequency range (I/O / C1 / C2): 5 - 2.400 MHz / 5 - 2.400 MHz / 5 - 2.400 MHz. Basic loss (FM / TV / SAT): 3,7±0,3 dB / 4,0±0,5 dB / 5,0±1,2 dB. Isolation (FM / TV / SAT): &gt;20 / &gt;20 / &gt;14. Return loss (VR / FM / TV / SAT): &gt;16 / &gt;16 / &gt;16 / &gt;9. DC path (Vdc / mA / Tono): 24 max. / 500 max. / 22 KHz - DiSEqC. Included: fixing claws. Cover plate code: 8650.</p>	<b>8151.7</b>	2CLA815170A1001	10
 <p><b>TV-R/SAT loop-through outlet</b> TV-R and SAT double outlet - Intermediate Installation as an intermediate outlet in series connected to each other. Output connectors (C1 / C2): IEC male 9,52 mm. diam. / IEC female 9,52 mm. diam. Frequency range (I/O / C1 / C2): 5 - 2.400 MHz / 5 - 2.400 MHz / 5 - 2.400 MHz. Basic loss (FM / TV / SAT): 10,0±1,0 dB / 10,0±1,0 dB / 12,0±2,0 dB. Through loss (FM / TV / SAT): 2,5±0,5 / 2,5±0,7 / 3,0±1,0. Directivity (FM / TV / SAT): &gt;20 / &gt;12 / &gt;5. Isolation (FM / TV / SAT): &gt;45 / &gt;30 / &gt;28. Return loss (VR / FM / TV / SAT): &gt;13 / &gt;13 / &gt;12 / &gt;12. DC path (Vdc / mA / Tono): 24 max. / 500 max. / 22 KHz - DiSEqC. Included: fixing claws. Cover plate code: 8650.</p>	<b>8151.8</b>	2CLA815180A1001	10
 <p><b>Cover plate for TV-R/SAT outlet</b> Cover plate for TV outlet code: 8150, 8150.3, 8150.7, 8151.3, 8150.7 &amp; 8150.8.</p>			

Chrome	<b>8650 CR</b>	2CLA865000A1401	20
Black Glass	<b>8650 CN</b>	2CLA865000A1501	20

## Sky Niessen

### Telephone & data outlets

Product	Article-No.	Order-No.	Pack/Qty
	<b>Telephone outlet RJ12</b> RJ12 type connector. 6 contacts. Suitable for 2 (6P2C), 4 (6P4C) or 6 (6P6C) RJ11 and RJ12 jacks. Screw terminals. Mounting grid delivered with the cover plate. Cover plate code: 8618.1 & 8618.2.		
	<b>2017.2</b>	2CLA201720A1001	10

	<b>Telephone outlet RJ45 Cat.3</b> RJ45 type connector. Cat.3. 8 contacts. Suitable for 8 (8P8C) RJ45 jacks. Tool-less wiring. Mounting grid delivered with the cover plate. Cover plate code: 8618.1 & 8618.2.		
	<b>2017.3</b>	2CLA201730A1001	10

	<b>Data outlet RJ45 Cat.5e UTP</b> RJ45 type connector. Cat.5e UTP. In compliance with ANSI/TIA/EIA 568B.2, ISO/IEC11801 & EN50173. Universal TIA/EIA 568A and 568B labeling. Housing: ABS UL-94-0. Durability: 750 cycles min. (ISO/IEC 11801, IEC 60603-7-4). IDC: PC UL94V-0, Accept 22-26AWG solid wire. Contact: RJ45 8P8C, 3~50 micro-inch gold plating over nickel plated on contact area. Tool-less wiring. Mounting grid delivered with the cover plate. Cover plate code: 8618.1 & 8618.2.		
	<b>2018.5</b>	2CLA201850A1001	10

	<b>Data outlet RJ45 Cat.6 UTP</b> RJ45 type connector. Cat.6 UTP. In compliance with ANSI/TIA/EIA 568B.2, ISO/IEC11801 & EN50173. Universal TIA/EIA 568A and 568B labeling. Housing: ABS UL-94-0. Durability: 750 cycles min. (ISO/IEC 11801, IEC 60603-7-4). IDC: PC UL94V-0, Accept 22-26AWG solid wire. Contact: RJ45 8P8C, 3~50 micro-inch gold plating over nickel plated on contact area. Tool-less wiring. Mounting grid delivered with the cover plate. Cover plate code: 8618.1 & 8618.2.		
	<b>2018.6</b>	2CLA201860A1001	10

	<b>Data outlet RJ45 Cat.6A STP</b> RJ45 type connector. Cat.6A STP. In compliance with ANSI/TIA/EIA 568B.2, ISO/IEC11801 & EN50173. Universal TIA/EIA 568A and 568B Labeling. 10 Gb/sec. Durability: 750 cycles min. (ISO/IEC 11801, IEC 60603-7-4). Housing: Zinc Die-casting design for optimal EMI protection. Slim size is ideal for interfaces where the spaces are tight. IDC: PC UL94V-0, Accept 22-26AWG solid wire. Contact: RJ45 8P8C, 3~50 micro-inch gold plating over nickel plated on contact area. Tool-less wiring. Mounting grid delivered with the cover plate. Cover plate code: 8618.1 & 8618.2.		
	<b>2018.7</b>	2CLA201870A1001	10

Product	Article-No.	Order-No.	Pack/Qty
	<b>Housing for data outlets - Keystone type</b> Housing for connectors with Keystone type clipping system. Mounting grid delivered with the cover plate. Cover plate code: 8618.1 & 8618.2.		
	<b>2018</b>	2CLA201800A1001	10

	<b>Housing for data outlets - Systimax type</b> Housing for connectors with Systimax type clipping system. Mounting grid delivered with the cover plate. Cover plate code: 8618.1 & 8618.2.		
	<b>2018.8</b>	2CLA201880A1001	10

	<b>Cover plate for data outlet 1-gang</b> Cover plate for data outlets code: 2017.2, 2017.3, 2018, 2018.5, 2018.6 & 2018.8. Included: mounting grid without claws. Without shutters and labeling area.		
Chrome	<b>8618.1 CR</b>	2CLA861810A1401	2
Black Glass	<b>8618.1 CN</b>	2CLA861810A1501	2

	<b>Cover plate for data outlet 2-gangs</b> Cover plate for data outlets code: 2017.2, 2017.3, 2018, 2018.5, 2018.6 & 2018.8. Included: mounting grid without claws. Without shutters and labeling area.		
Chrome	<b>8618.2 CR</b>	2CLA861820A1401	2
Black Glass	<b>8618.2 CN</b>	2CLA861820A1501	2

## Sky Niessen

### Light controls - Rotatory dimmers

Product	Article-No.	Order-No.	Pack/Qty
	<b>Universal rotatory/push dimmer</b> Rated voltage: 230 Vac / 50 Hz. Min. power: 60 W / VA. Max. power: - Incandescent: 500 W. - Halogen lamp with electronic transformer: 500 VA. - Halogen lamp with ferromagnetic transformer: 400 VA. 2 wire connection. Optional: auxiliary control with 8104.X push-buttons. Indicator LED lamp included. Operating temperature: 0 - 30° C. Included: - Cover plate with chrome ring. - Mounting grid without claws.		
Chrome	<b>8660 CR</b>	2CLA866000A1401	1
Black Glass	<b>8660 CN</b>	2CLA866000A1501	1

	<b>LED rotatory/push dimmer</b> Rated voltage: 230 Vac ± 10%. Frequency: 50 Hz (Nominal power: 250 W/VA) / 60 Hz (Nominal power: 200 W/VA). Power (min./max load): - LEDi: 2 / 100 W/VA (max. 10 lamps). - Dimmable energy saving lamps: 2 / 100 W/VA (max. 10 lamps). - LV LEDi with transformer (only type L or LC): 4 / 100 W / VA (max. 10 lamps). - Incandescent lamps: 10 / 250 W / VA. - Halogen lamps: 10 / 250 W / VA. - LV halogen with transformer (only type L or LC): 10 / 250 W/VA (max. 10 lamps). 2 wire connection. Optional: auxiliary on/off with 2-way switch 8102. Indicator LED lamp included. Back-up fuse: Electronic. Overload protection: Electronic. Ambient temperature: 0° C to +35° C. Included: - Cover plate with chromes ring. - Mounting grid without claws.		
Chrome	<b>8660.2 CR</b>	2CLA866020A1401	1
Black Glass	<b>8660.2 CN</b>	2CLA866020A1501	1

	<b>1-10V rotatory dimmer</b> Rated voltage: 127 - 230 Vac / 50 - 60 Hz. Dimmable electronic ballast/driver with 1-10V control input. Max. power: - 230 Vac: 700 VA. - 127 Vac: 350 VA. Max. 6 ballasts per device. Indicator LED lamp included. Included: - Cover plate with chrome ring. - Mounting grid without claws.		
Chrome	<b>8660.9 CR</b>	2CLA866090A1401	1
Black Glass	<b>8660.9 CN</b>	2CLA866090A1501	1

### Buzzer / Door bell

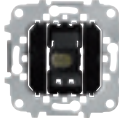
Product	Article-No.	Order-No.	Pack/Qty
	<b>Buzzer</b> Rated voltage: 230 Vac / 50 Hz. Rated power: 8 VA. Adjustable tone. Acoustic power at 1 meter with cover plate: 75 dB. Without fixing claws. Cover plate code: 8629.		
	<b>8119</b>	2CLA811900A1001	10

	<b>Electronic door bell with 4 melodies</b> Rated voltage: 110 - 250 Vac. 4 melodies available. Acoustic power at 1 meter with cover plate: 72 dB. Without fixing claws. Cover plate code: 8629.		
	<b>8124.2</b>	2CLA812420A1001	1

	<b>Cover plate for buzzer/door bell</b> Cover plate for buzzer / door bell code: 8119 & 8124.2.		
Chrome	<b>8629 CR</b>	2CLA862900A1401	5
Black Glass	<b>8629 CN</b>	2CLA862900A1501	5

### Blank covers / Cable outlets

Product	Article-No.	Order-No.	Pack/Qty
	<b>Blank cover plate</b> Included: mounting grid and cover plate. Without fixing claws.		
Chrome	<b>8600 CR</b>	2CLA860000A1401	2
Black Glass	<b>8600 CN</b>	2CLA860000A1501	2

	<b>Cable outlet</b> 3 connection screw terminals up to 2,5 mm2. Cable tie included. Included: fixing claws. Cover plate code: 8607.		
	<b>8107</b>	2CLA810700A1001	10

	<b>Cover plate for cable outlet</b> Cover plate for cable outlet code: 8107.		
Chrome	<b>8607 CR</b>	2CLA860700A1401	5
Black Glass	<b>8607 CN</b>	2CLA860700A1501	5

---

## Sky Niessen - Frames



01

---

### Skymoon Glass

01 White Glass

02 Black Glass

---



02



03

---

### Skymoon Steel

03 Stainless steel

---

## Sky Niessen - Frames

### White Glass

Product	Article-No.	Order-No.	Pack/Qty	
 <p><b>Frames 1 to 3-gang - Noble - White Glass</b>                      Material: glass.                      Size (height x width):                      - 1-gang: 86 x 86 mm.                      - 2-gang: 86 x 157 mm.                      - 3-gang: 86 x 228 mm.                      Flush mounting boxes code: 1099, 1999 &amp; 1999.2.                      Surface mounting boxes code: 8591, 8592 &amp; 8593.</p>	1-gang	<b>8671 CB</b>	2CLA867100A3001	1
	2-gang	<b>8672 CB</b>	2CLA867200A3001	1
	3-gang	<b>8673 CB</b>	2CLA867300A3001	1

### Stainless Steel

Product	Article-No.	Order-No.	Pack/Qty	
 <p><b>Frames 1 to 3-gang - Noble - Stainless Steel</b>                      Material: stainless steel.                      Size (height x width):                      - 1-gang: 86 x 86 mm.                      - 2-gang: 86 x 157 mm.                      - 3-gang: 86 x 228 mm.                      Flush mounting boxes code: 1099, 1999 &amp; 1999.2.                      Surface mounting boxes code: 8591, 8592 &amp; 8593.</p>	1-gang	<b>8671 OX</b>	2CLA867100A4001	1
	2-gang	<b>8672 OX</b>	2CLA867200A4001	1
	3-gang	<b>8673 OX</b>	2CLA867300A4001	10

### Black Glass

Product	Article-No.	Order-No.	Pack/Qty	
 <p><b>Frames 1 to 3-gang - Noble - Black Glass</b>                      Material: glass.                      Size (height x width):                      - 1-gang: 86 x 86 mm.                      - 2-gang: 86 x 157 mm.                      - 3-gang: 86 x 228 mm.                      Flush mounting boxes code: 1099, 1999 &amp; 1999.2.                      Surface mounting boxes code: 8591, 8592 &amp; 8593.</p>	1-gang	<b>8671 CN</b>	2CLA867100A3101	1
	2-gang	<b>8672 CN</b>	2CLA867200A3101	1
	3-gang	<b>8673 CN</b>	2CLA867300A3101	1



---

## Sound system

A soundtrack in each space



**Improve the sound of all your projects. The first sound system that adapts to the current way of listening to music and radio.** With Bluetooth and USB input to connect it to your mobile devices, and with Multiroom function to hear one melody in each space or the same in all rooms. Sky Niessen sound system is an innovative solution that thanks to its many advantages you can offer your customers to increase the value of your facilities. With the quality of ABB you already know and with a very simple installation that does not require work.



# Music from any device



## Each person has his own musical universe

A compilation of artists that accompanies us on the smartphone, tablet, computer or even in the "cloud" or a streaming system. **Sky Niessen sound system is a door so that**

**each person can access their musical universe** from each room of their home or their work, in a simple way and with the maximum quality of sound.



**Bluetooth and USB:** It allows you to control the music from a smartphone or tablet via Bluetooth or play the music stored in USB devices.

Compatible with the main operating systems as iOS, Android, Windows Phone, Mac OS, Windows...

Sky Niessen sound system also offers the possibility to listen to music from streaming platforms like Spotify, Google

Play Music, Apple Music, Amazon Music Unlimited, Napster... or any online streaming music or radio provider.





---

# Multiroom



## A different music in each room or the same in all the rooms, it's your choice

The installation **allows to control what music is heard in each room**, personalizing it in each case. In this way a person can listen to rock in the room, while in the kitchen classical music sounds. And the same in the workspaces, since in each office or meeting room you can tune in different music. But at any

time you can play the same music in all spaces equipped with Sky Niessen sound system, thanks to the multiroom function.

## Brings innovation to your home

It offers the sound quality of ABB in a device that will allow your customers to listen to a different music in each room. In

addition, its **avant-garde design** makes Sky Niessen sound system the perfect ally of the decoration in any space.

# Ease in your projects



## Easy installation

To enjoy the Sky Niessen sound system **you will not have to do work, because it is installed just like a switch**, you only need a hole with a power supply.

Whether it is a new installation or a refurbishment, the Sky Niessen sound system can be installed very simply.

When using the ceiling module, to enjoy its FM radio or Bluetooth connection functionality no additional wiring to the power supply is required, since the communication between the ceiling module and the wall mounted remote control is wireless.



## Also in the renovation



### It adapts to the needs of each space

If you already have an old sound system from ABB or another brand, you can replace the old controls with the new modules of the Sky Niessen sound system and continue using the speakers already installed. You will not need to have more holes in the wall than the existing ones, you can use those of the controls of your old sound system.

If you do not have a sound system, you can easily install a remote control on the wall taking advantage of any point where you have two standard 1-gang switches of ABB.

These two 1-gang switches can be changed by a 2-gang switch mounted in a single 1-gang box and occupy the other 1-gang box that remains free with the remote control of the Sky Niessen sound system.

Now only one or several 5 "loudspeakers (up to 4 loudspeakers per channel) have to be installed in the ceiling and, taking advantage of the hole created for the loudspeakers, housing the ceiling module next to the module.

## Sky Niessen - Sound system

### Multiroom Bluetooth system

Product	Article-No.	Order-No.	Pack/Qty
	<b>Multiroom sound module</b> Rated voltage: 127-230 Vac ± 15%; 50-60 Hz. Max. consumption: 200 mA. Stand-by consumption: 0,3W. Amplifier power: 6+6 W; <1% distortion (4 Ω). Speaker impedance: 4 Ω (2+2 W audio). FM radio digital tuner with RDS. Alarm clock with buzzer, radio types and snooze function. Bluetooth receiver: Bluetooth® v2.1 2.4GHz IEEE 802.15.1. Multiroom function available (1 master device and up to 14 slave devices). Remote control using code 9368.2 (ZigBee 2.4GHz IEEE 802.15.4). Optional: auxiliary module 9368.3 for I/O (1 mini-jack stereo input & 1 mini-jack stereo output) and USB connection functions.		
	<b>9368.1</b>	2CLA936810A1001	1



**Remote control for multiroom sound module - 2M**  
Rated voltage: 127-230 Vac ± 15%; 50-60 Hz.  
Max. consumption: 15 mA.  
Stand-by consumption: 0,5W.  
To control 9368.1 module (1 remote control for each module).  
Wireless connection between moles 9368.1 and 9368.2 (ZigBee 2.4GHz IEEE 802.15.4).  
Optional: auxiliary module 9368.3 for I/O (1 mini-jack stereo input & 1 mini-jack stereo output) and USB connection functions. In case of using 9368.3 module, the connection between modules 9368.1 and 9368.2 must be wired (3 wires).  
Mounting grid delivered with the cover plate (without fixing claws).  
Cover plate code: 8568.

**9368.2** 2CLA936820A1001 1



**Cover plate for radio/remote control modules**  
Cover plate for FM-radio module and for remote control module code: 9368, 9368.2 & 9368.7.  
Included: cover plate and mounting grid.  
Without fixing claws.

Soft White	<b>8568 BL</b>	2CLA856800A1101	1
Silver	<b>8568 PL</b>	2CLA856800A1301	1
Soft Black	<b>8568 NS</b>	2CLA856800A1501	1
Stainless Steel	<b>8568 AI</b>	2CLA856800A1401	1
Antique Gold	<b>8568 OE</b>	2CLA856800A1201	1

### FM radio with alarm

Product	Article-No.	Order-No.	Pack/Qty
	<b>FM-radio and alarm module - 2M</b> Rated voltage: 230 Vac ± 15%; 50-60 Hz. Max. consumption: 100 mA. Stand-by consumption: 0,2W. Amplifier power: 2+2 W; <1% distortion (16 Ω). Speaker impedance: 16 Ω (2+2 W audio). FM radio digital tuner with RDS. Alarm clock with buzzer, radio types and snooze function. Optional: auxiliary module 9368.3 for I/O (1 mini-jack stereo input & 1 mini-jack stereo output), USB connection and Bluetooth receiver functions. Mounting grid delivered with the cover plate (without fixing claws). Cover plate code: 8568.		
	<b>9368</b>	2CLA936800A1001	1



**FM-radio and alarm module - 2M**  
Rated voltage: 127 Vac ± 15%; 50-60 Hz.  
Max. consumption: 100 mA.  
Stand-by consumption: 0,2W.  
Amplifier power: 2+2 W; <1% distortion (16 Ω).  
Speaker impedance: 16 Ω (2+2 W audio).  
FM radio digital tuner with RDS.  
Alarm clock with buzzer, radio types and snooze function.  
Optional: auxiliary module 9368.3 for I/O (1 mini-jack stereo input & 1 mini-jack stereo output), USB connection and Bluetooth receiver functions.  
Mounting grid delivered with the cover plate (without fixing claws).  
Cover plate code: 8568.

**9368.7** 2CLA936870A1001 1





**Cover plate for radio/remote control modules**  
Cover plate for FM-radio module and for remote control module code: 9368, 9368.2 & 9368.7.  
Included: cover plate and mounting grid.  
Without fixing claws.

Soft White	<b>8568 BL</b>	2CLA856800A1101	1
Silver	<b>8568 PL</b>	2CLA856800A1301	1
Soft Black	<b>8568 NS</b>	2CLA856800A1501	1
Stainless Steel	<b>8568 AI</b>	2CLA856800A1401	1
Antique Gold	<b>8568 OE</b>	2CLA856800A1201	1

## Sky Niessen - Sound system

### Auxiliary module

Product	Article-No.	Order-No.	Pack/Qty
	<b>Auxiliary module - 2M</b> Power supply through 9368, 9368.2 or 9368.7 modules. Max. consumption: 200 mA. Stand-by consumption: 0,4W. Bluetooth receiver: Bluetooth® v2.1 2.4GHz IEEE 802.15.1. USB connector: for MP3 and WAV files. Max. consumption of the connected device: 100 mA @5Vdc. Input: 1x mini-jack stereo 3,5 mm. Output: 1x mini-jack stereo 3,5 mm. Mounting grid delivered with the cover plate (without fixing claws). Cover plate code: N2268.3.		
	<b>9368.3</b>	2CLA936830A1001	1

	<b>Cover plate for I/O + USB + Bluetooth module</b> Cover plate for I/O + USB + Bluetooth module code: 9368.3. Included: cover plate and mounting grid. Without fixing claws.		
Soft White	<b>8568.3 BL</b>	2CLA856830A1101	1
Silver	<b>8568.3 PL</b>	2CLA856830A1301	1
Soft Black	<b>8568.3 NS</b>	2CLA856830A1501	1
Stainless Steel	<b>8568.3 AI</b>	2CLA856830A1401	1
Antique Gold	<b>8568.3 OE</b>	2CLA856830A1201	1

## Sky Niessen - Sound system

### 2" loudspeaker for wall

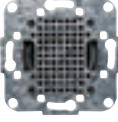
Product	Article-No.	Order-No.	Pack/Qty
	<b>2" loudspeaker 2 W</b> Compatible with sound modules and amplifier code: 9368, 9368.1, 9368.7 and 9335.1. With broadband characteristics. With screwless terminals. Rated output: 2 W (RMS). Frequency response: 150 - 16.000 Hz. Impedance: 16 Ohm. Mounting depth: 34 mm. Without fixing claws. Cover plate code: 8529, 8629 & 9399.4.		
	<b>9329</b>	2CLA932900A1001	1



**Cover plate for 2" loudspeaker**  
Cover plate for 2" loudspeaker code: 9329.

Soft White	<b>8529 BL</b>	2CLA852900A1101	5
Silver	<b>8529 PL</b>	2CLA852900A1301	5
Soft Black	<b>8529 NS</b>	2CLA852900A1501	5
Stainless Steel	<b>8529 AI</b>	2CLA852900A1401	5
Antique Gold	<b>8529 OE</b>	2CLA852900A1201	5



**Cover plate for 2" loudspeaker**  
Cover plate for 2" loudspeaker code: 9329.

Chrome	<b>8629 CR</b>	2CLA862900A1401	5
Black Glass	<b>8629 CN</b>	2CLA862900A1501	5



**Embellishing grid for 2" loudspeaker**  
Embellishing grid for 2" loudspeaker code: 9329.  
Plastic material.

White	<b>9399.4 BA</b>	2CLA939940A1001	5
Black	<b>9399.4 NG</b>	2CLA939940A1501	5

### 5" loudspeaker for ceiling

Product	Article-No.	Order-No.	Pack/Qty
	<b>5" loudspeaker 6 W</b> Compatible with sound modules and amplifier code: 9368, 9368.1, 9368.7 and 9335.1. With broadband characteristics. With screw terminals. Rated output: 6 W (RMS). Frequency response: 70 - 10.000 Hz. Impedance: 16 Ohm. Flush mounted installation with 9399 mounting box or 9399.1 mounting ring. Embellishing grid code: 9399.2.		
	<b>9329.1</b>	2CLA932910A1001	1



**Installation box for 5" loudspeaker**  
For 9329.1 loudspeaker.  
For flush-mounted assembly.  
Drilling measurements: 174 mm.  
Mounting depth: 84 mm.

**9399** 2CLA939900A1001 12



**Installation ring for 5" loudspeaker**  
For 9329.1 loudspeaker.  
For mounting in hollow walls/ceilings.  
With spring brackets.  
Drilling measurements: 160 mm.  
Mounting depth: 110 mm.

**9399.1** 2CLA939910A1001 12



**Embellishing grid for 5" loudspeaker**  
Embellishing grid for 5" loudspeaker code: 9329.1.  
Plastic material.  
With central fixation screw.

**9399.2** 2CLA939920A1001 12

### Auxiliary amplifier





**Auxiliary 20W amplifier**  
Rated voltage: 230 Vac  $\pm$  10 % / 50-60 Hz.  
Power consumption: 3,5 VA (max. 36 VA).  
Output voltage: 15 V- (max. 1,5 A).  
Output power:  
- 10 + 10 W (2  $\Omega$ ).  
- 20 W (4  $\Omega$ ).  
Speaker impedance:  
- 2 - 16  $\Omega$  (10 + 10 W).  
- 4 - 16  $\Omega$  (20 W).  
Can be operated in booster mode with FM radio modules 9368 and 9368.7 and multiroom modules 9368.1.  
Can be operated in "standalone" mode with one audio input.  
Can be used in bridge operation.  
For extending the number of speakers at one amplifier insert.  
For max. 16 speakers code 9329 or 9329.1.  
DIN-rail installation. Module width: 7.

**9335.1** 2CLA933510A1001 1

## Sky Niessen - Sound system

### Potentiometers

Product	Article-No.	Order-No.	Pack/Qty
	<b>Potentiometer for loudspeakers 3W</b> Wire-wound potentiometer. 3 W / 27 Ω. For low impedance circuits. Without fixing claws. Cover plate code: 8559.		
	<b>8159.3</b>	2CLA815930A1001	1

	<b>Potentiometer for loudspeakers 5W</b> Wire-wound potentiometer. 5 W / 47 Ω. For low impedance circuits. Without fixing claws. Cover plate code: 8559.		
	<b>8159.5</b>	2CLA815950A1001	1

	<b>Cover plate with rotatory knob for potentiometer</b> Cover plate with rotatory knob for potentiometer: 8159.3 & 8159.5.		
Soft White	<b>8559 BL</b>	2CLA855900A1101	1
Silver	<b>8559 PL</b>	2CLA855900A1301	1
Soft Black	<b>8559 NS</b>	2CLA855900A1501	1
Stainless Steel	<b>8559 AI</b>	2CLA855900A1401	1
Antique Gold	<b>8559 OE</b>	2CLA855900A1201	1

### Connection units

Product	Article-No.	Order-No.	Pack/Qty
	<b>Speaker connection unit</b> Front: 2x spring speaker terminals (Red/Black). Rear: 2x screw terminals. Without fixing claws. Cover plate code: 8557.1.		
	<b>8157.1</b>	2CLA815710A1101	1

	<b>Cover plate for speaker connection unit</b> Cover plate for speaker connection unit code: 8157.1.		
Soft White	<b>8557.1 BL</b>	2CLA855710A1101	1
Silver	<b>8557.1 PL</b>	2CLA855710A1301	1
Soft Black	<b>8557.1 NS</b>	2CLA855710A1501	1
Stainless Steel	<b>8557.1 AI</b>	2CLA855710A1401	1
Antique Gold	<b>8557.1 OE</b>	2CLA855710A1201	1



# — Sky Niessen & ABB-free@home®

Making home automation easier than ever



**Simply smart. ABB-free@home® transforms the house or the apartment into an intelligent home.** Whether blinds, lights, heating, air conditioning, door communication or scenes. Easy to remote control via a switch on the wall, with the laptop or with the smartphone. Very convenient. Extremely comfortable. Very energy efficient. Especially attractive: Only minimal costs are involved when compared with conventional electrical installations.





—  
FREEDOM

# Home becomes smart







---

## Just as you like it

### The Smart Home

The perfect daily routine. With ABB-free@home® and Sky Niessen, the entire home can be controlled not only with switches, but now even more practically: by smartphone or tablet and via touch or voice control. This allows home automation to be managed in a way that's mobile and smart, precise and flexible. For example, if the light atmosphere needs to be changed, tapping on the touchscreen or a simple voice command moves the blinds or changes the colours of the lights. Experience the future of smart living today.

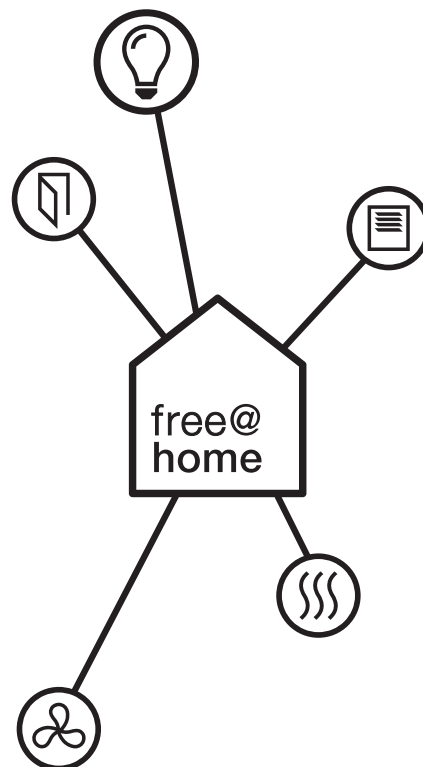





---

# Free choice

## Live as your heart desires

Smart. ABB-free@home® transforms the house or the apartment into an intelligent home. Whether blinds, lights, heating, air-conditioning or door communication – comfort, safety and efficiency can finally be remotely controlled. Via a switch on the wall, via voice control or with a smartphone, tablet or personal computer.

### **The pleasure of simplicity**

ABB-free@home® makes daily life easier. You can manage blinds, lights, heating, air-conditioning and door communication using just one system. The smartphone becomes the remote control in the house. It allows you to raise the blinds and switch on the radio in the kitchen with the touch of a button while you are still in bed – or to deactivate all lights and devices via a switch when leaving the house. Very convenient. Extremely comfortable. Very energy efficient. The setting of these scenes is as easy as can be – to suit the mood or situation.





**Open for new ideas**

With ABB-free@home® everyone can determine for themselves how they want to use the smart living technologies. Both individual functions, such as heating or control of blinds, or a combination of different functions can be implemented. Over the course of time the system can also be flexibly extended, if one so desires. Freedom of choice at all times.



Blind



Light



Heating



Air-conditioning



Door communication



---

## Total networking

Blinds, lights, heating, air-conditioning, door communication

Comfortable right from the start. It begins with commissioning and continues later when used as a part of daily life. With ABB-free@home® and Sky Niessen all applications in and around the house are amazingly easy to combine.

### Blinds

Whether blind, roller blind, awning or roller door – with ABB-free@home®, sun protection and energy-saving could not be easier. Opening and closing, as well as adjustment of slats can be automated and controlled with switches, ABB-free@homeTouch (two sizes are available: 7" and 4.3") or the app for smartphone or tablet. In addition, a weather station for protection during a storm, a

timer or astro function can be used. It automatically adjusts the blind according to sunrise and sunset. The relevant data are combined in the System Access Point and are precisely implemented. The panel displays a comprehensive overview of all measured values and time settings.





### Weather station

One thing is certain: the weather cannot be precisely predicted. The weather station records the brightness, temperature, rain and wind speed outside the home. Weather data are sent immediately and linked with actuators to automatically control functions. All important data are clearly displayed in the ABB-free@home® app.

- Provides numerous control options, dependent on brightness, temperature, rainfall and wind speed
- Shows weather data on the smartphone, tablet and display
- Reliably protects blinds and awnings against the effects of weather
- Optimises energy efficiency



### Blind switch

Ready for all operating modes. With either a short or long press of the button for roller blinds, exterior blinds or awnings as well as adjustment of slats. In combination with a wind sensor, the roller blinds, exterior blinds and awnings close up completely and are locked during high wind conditions.



For a reassuring feeling. The various modules interact smoothly with one another, providing extra comfort, safety and efficiency. Every detail is aesthetically lit up, in all locations, both outside and inside the home.



#### Door communication

The ABB-Welcome door communication system can be integrated into ABB-free@home®. The door communication and home automation can be used together with ABB-free@homeTouch 7". For example, the light switches on when the doorbell rings to see visitors more clearly. And for reasons of safety, the video camera records pictures of visitors at the door when no one is home.



#### Pictures shown on the display

Practical and convenient. The pictures recorded by the video camera can be displayed on the tablet or smartphone via the ABB-Welcome app. This allows visitors who ring the bell to be recognised even when you are not at home (requires the ABB-Welcome IP gateway and ABB-Welcome outdoor video station).



- Large touch display (7", 17.8cm), to recognise who is at the door
- Easy operation keys for opening doors, mute function and light
- Integrated picture memory
- Configuration of "Welcome scenes" when a visitor rings the bell or the door is opened

#### Smart control via app and voice

Smartphone or tablet becomes the central control unit of the door communication. The ABB-Welcome app also makes remote control via the Internet possible. This makes communication possible with all visitors. Now you are at home everywhere.

**Philips hue LEDs**

Simply integrate the Philips hue LEDs into the system and control them via ABB-free@home®. This allows hue lamps to be comfortably controlled via a switch on the wall, or in a scene together with other lamps, even when the smartphone or tablet is not available.

**Light control**

Life begins with light. With ABB-free@home® it can be optimally used, whether for illuminating individual rooms or the entire house. For example, with striking light scenes – for different moods and to suit the occasion. A pleasant side effect here is the cost-saving and environmentally friendly use of energy.

- Easy to adjust light scenes
- Central or remote control
- Fast activation of emergency lighting
- Support of energy efficiency
- Flexible use
- Philips hue LED integration

**Dimmer and movement detector**

With ABB-free@home®, rooms or entire buildings can be illuminated according to your requirements. Each situation receives suitable light – whether striking light scenes or emergency lighting. All lights are switched on at once.

Pleasantly economical. The ideal room temperature throughout the day and night is the result of precise control. ABB free@home® connects all components for a fine-tuned indoor climate.



#### Heating and air-conditioning

Comfortable and energy-saving. The optimum room temperature can be adjusted with ABB-free@home® according to the actual requirement. In ECO mode, the temperature is automatically lowered at night or when no one is home. The heating can be automatically shut off when the windows are open. This reduces the energy consumption – whether for conventional heaters or under-floor heating.

The ideal temperature is never the same. Depending on the time of the day, the room temperature controller provides your personal feel-good temperature. The heating valves are controlled wirelessly – with radio-controlled thermal actuating drives. The room temperature controllers can be integrated into the switch combination. And the window contacts are net-worked wirelessly as well. That is both smart and efficient.







**Intelligent thermostat**

Radiator valve drives are the active components of individual room temperature control. They control all valves on the respective radiators. These drives use an electric motor to open or close the heating valves. They operate quietly and are not subject to movement-related wear. The ABB-free@home® network enables the finest nuances to be implemented, for the perfect climate at all times.

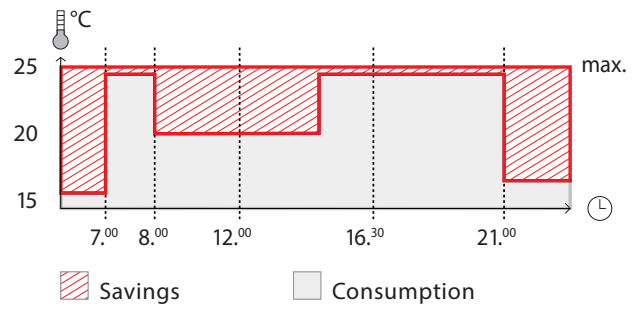

Energy savings due to the individual control of heating depending on the time of day

- Easy to retrofit
- No cooling or heating when windows are open



- Heating to suit individual requirements: depending on the daily routines instead of specific requirements
- For conventional heaters or under-floor heating
- Support of energy efficiency
- ECO mode
- Local operation or remote controlled via app for smartphone and tablet



---

**THE SYSTEM**

ABB-free@home® is easy to operate and at the same time flexible and adaptable to everyday situations or to those very special moments in life. And here, complete scenes can be played automatically or be set or called up spontaneously to suit the mood









---

# Atmosphere at the press of a button

## With a personal comfort scene

The perfect evening after a day at work. ABB-free@home® prepares a pleasant reception when arriving at home. With a colourful display of light and ambient room temperature. Precisely the right atmosphere for relaxing.



**Philips hue LEDs**

All functions of the Philips hue LEDs can be integrated in a scene. In addition to the brightness, the colour shade can also be defined in a scene.

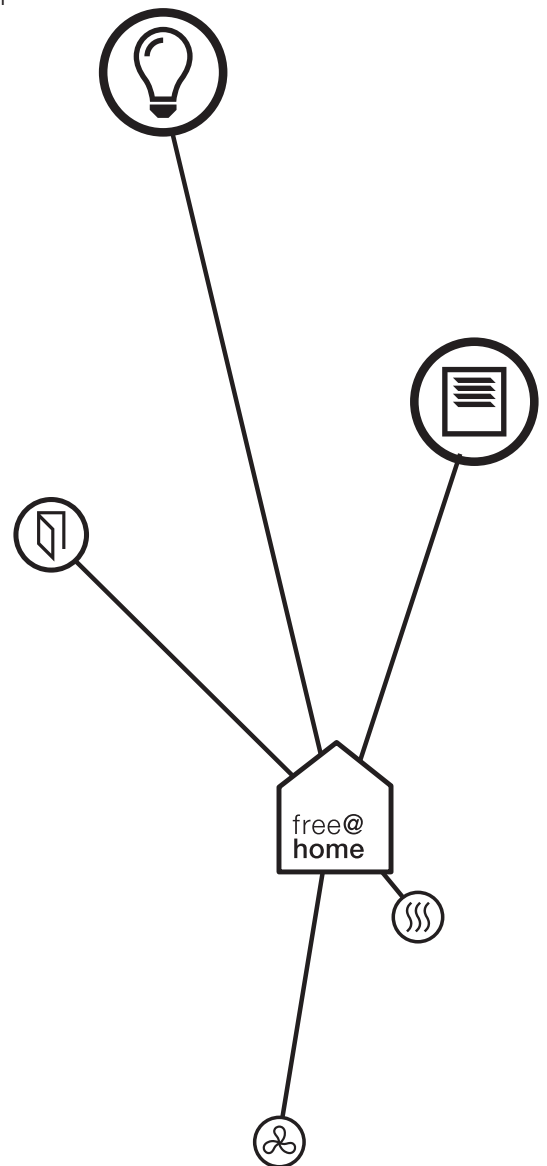
**Fast change of scene**

A single press of the button on the switch, on the ABB-free@homeTouch, smartphone or tablet suffices to call up a complete scene. This, for example, allows a living room to be transformed in a matter of seconds to suit an occasion – for welcoming guests or for a pleasant evening of relaxation.

**Simple scene configuration**

To create or change your own individual scenes is child's play with ABB-free@home®. An intelligent assistance wizard helps to put together the desired functions. This, for example, allows the working light, cooker hood and Internet radio to be simultaneously activated via a binary output, while also dimming the light at the dinner table – again with a press of a button.



# Present and yet not at home

## With presence simulation

Everything is in perfect order at home. Because ABB-free@home® and Sky Niessen brings life into rooms that are at times unoccupied. For this the system stores the habits of the residents while they are at home and then calls them up during their absence.

- Free app for iOS and Android devices
- Integrated picture memory
- Easy remote control via myABB-LivingSpace

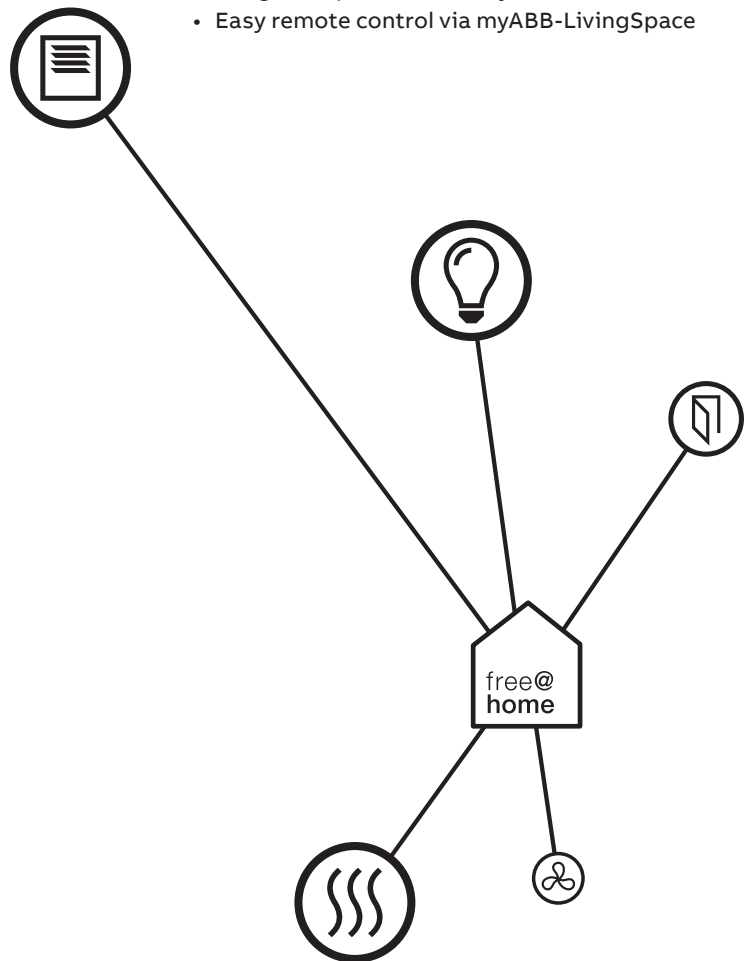

### Remote control for everything

Always a good feeling. The presence simulation of ABB-free@home® records the weekly sequence of the devices. This means that it's response is completely the same whether the residents are present or absent. Whether on a business trip, on holiday or while shopping around the corner. With the app on the smartphone, remote control and a safety check of the entire home is possible from anywhere in the world.

### Automatic protection against wind

During windy weather and storms, ABB-free@home® together with a conventional weather station ensures blinds are automatically raised. This prevents damage such as buckling of the slats or broken window panes. This function is of particular benefit during one's absence because weather can change unexpectedly.



#### **A complete overview**

Always in the know about what is happening at home. With the ABB-free@home® app you can check at any time whether all the windows are closed or if someone has forgotten to switch off the lights. Also practical is the single, unified account for ABB-Welcome and ABB-free@home®.



myABB-LivingSpace

#### **Everything controllable**

Via the connection to the myABB-LivingSpace portal, most functions of ABB-free@home® can now be controlled and activated via remote control. This makes it possible to maintain control – even while on holiday, with maximum protection of one's privacy. Those who do not use a remote control can operate their ABB-free@home® system from the cloud.

---

# Everything off with a single function

## A reassuring feeling

The simplest type of switch-off. ABB-free@home® offers this with the everything-off function. It is especially practical when leaving the house. It simultaneously switches off all networked devices in all rooms.



### Rest assured

In principle the everything-off function works just like a pre-set scene. In this case all networked devices are simultaneously switched off in all rooms. Aside from improving safety, this also improves energy efficiency. The everything-off

function is especially practical at the bedside. Before falling asleep the entire lighting in the house can be switched off with just a press of a button. A very practical function that adds comfort and safety.

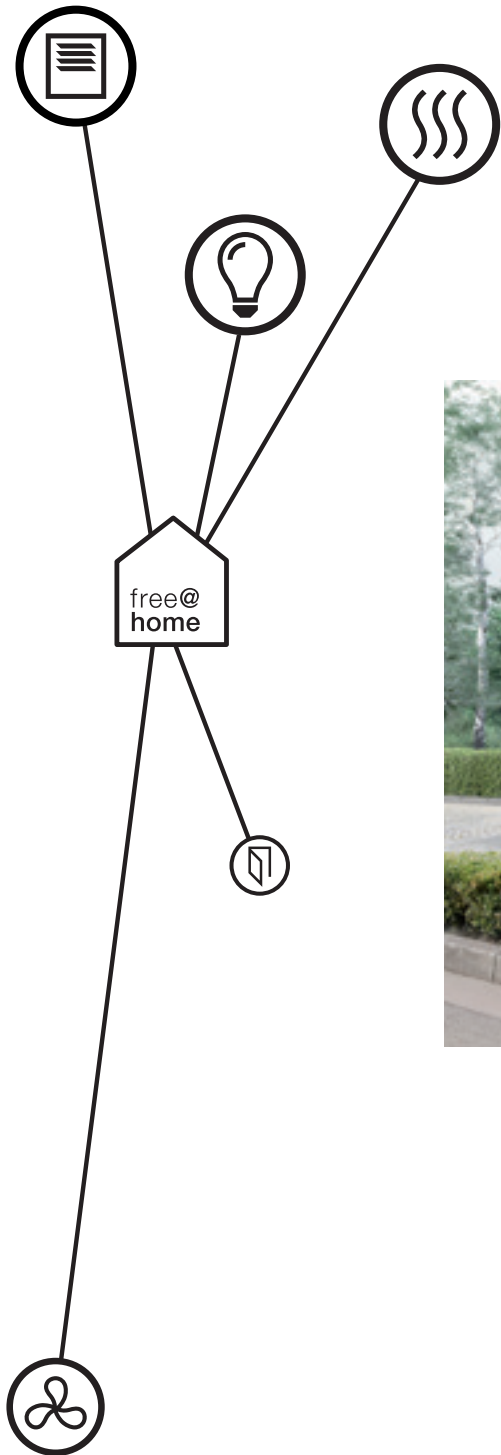

Pre-programmed everything-off switch  
Easy to operate



**Near and far**

The central switch for the everything-off function can be located on the wall near the front door and, of course, at any other location in the house. And for mobile use it can be displayed in the app on the smartphone or tablet.



## Easy to use

### A variety of control options

The new independence. Creating the perfect indoor climate or ideal illumination can now be done via flexible and precise remote control – with the touch of a finger or voice commands. Operation as simple as desired.

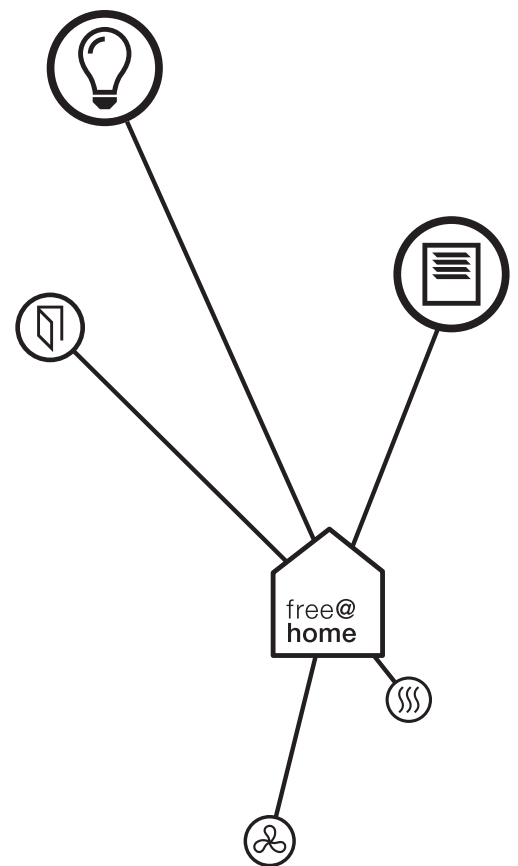

#### ABB-free@homeTouch

Thanks to its two different colours (black and white) and its two different sizes (7" and 4.3"). Offers up to 16 functions, and intuitive operation via tapping or swiping. Easy to set up and even easier to operate – plus making adjustments is a snap.

#### The modern switch

The easiest operation is the one everyone is used to. And today's wall switch is always in the right place. This is especially so because the wireless version makes additional cabling unnecessary. Switches are the better performers.

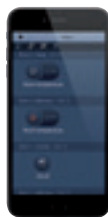

“Switch on the ceiling light in the living room.”

“Okay. The light ‘ceiling light’ in the living room has been switched on.”

#### Tablet and smartphone



The operating concept provides the highest flexibility and mobility because everyone has the choice to control the functions also mobile via the smartphone or tablet. And thanks to the ABB-free@home® app, also with the tip of the finger while travelling. Easier than ever.

#### Voice control

The intelligent voice control makes the ABB-free@home® app respond to every word. If you say “Switch the ceiling light on”, the system will ask “Do you mean the ‘ceiling light’ in the kitchen, in the living room or in the bathroom?”. Very handy if you don’t feel like getting up at the moment.

## Sky Niessen - Free@home - Home automation

### Sensors

Product	Article-No.	Order-No.	Pack/Qty
 free@home Sensor unit - 1-gang For sending switching, dimming and blind commands to an ABB-free@home® actuator. Control element: Switch contacts top/ bottom. Display elements: LED as light for orientation or display of switching state. Mounting depth: 9 mm. To be installed with SR-1-85, SRL-1-85, SRD-1-85, SRB-1-85 and SRS-1-85 cover plates.	SU-F-1.0.1	2CKA006220A0117	1
 free@home Sensor unit - 2-gang For sending switching, dimming and blind commands to an ABB-free@home® actuator. Control element: Switch contacts top/ bottom. Display elements: LED as light for orientation or display of switching state. Mounting depth: 9 mm. To be installed with SR-2-85, SRL-2-L-85 SRL-2-R-85, SRD-2-L-85, SRD-2-R-85, SRB-2-85 SRS-2-L-85 and SRS-2-R-85 cover plates.	SU-F-2.0.1	2CKA006220A0118	1



### Sensor & switch actuators

Product	Article-No.	Order-No.	Pack/Qty
 free@home Sensor/Switch actuator - 1/1-gang For switching 230 V~ devices. With 1 integrated switch actuator. Switching function is available pre-configured. Outputs: 1x normally open contact, potential free. Suitable for: resistive. Rated current: 10 A. Rated power: 2300 W. Suitable for: capacitive. Rated current: 10 AX. Mounting depth: 32 mm. To be installed with SR-1-85, SRL-1-85, SRD-1-85, SRB-1-85 and SRS-1-85 cover plates.	SSA-F-1.1.1	2CKA006220A0123	1
 free@home Sensor/Switch actuator - 2/1-gang For switching 230 V~ devices. With 1 integrated switch actuator. Switching function is available pre-configured. Outputs: 1x normally open contact, potential free. Suitable for: resistive. Rated current: 10 A. Rated power: 2300 W. Suitable for: capacitive. Rated current: 10 AX. Mounting depth: 32 mm. To be installed with SR-2-85, SRL-2-L-85 SRL-2-R-85, SRD-2-L-85, SRD-2-R-85, SRB-2-85 SRS-2-L-85 and SRS-2-R-85 cover plates.	SSA-F-2.1.1	2CKA006220A0124	1
 free@home Sensor/Switch actuator - 2/2-gang For switching 230 V~ devices. With 2 integrated switch actuator. Switching function is available pre-configured. Outputs: 2x normally open contact, potential free. Suitable for: resistive. Rated current: 10 A. Rated power: 2 x 1200 W. Suitable for: capacitive. Rated current: 10 AX. Mounting depth: 32 mm. To be installed with SR-2-85, SRL-2-L-85 SRL-2-R-85, SRD-2-L-85, SRD-2-R-85, SRB-2-85 SRS-2-L-85 and SRS-2-R-85 cover plates. Mounting depth: 32 mm. To be installed with SR-2-85, SRL-2-L-85 SRL-2-R-85, SRD-2-L-85, SRD-2-R-85, SRB-2-85 SRS-2-L-85 and SRS-2-R-85 cover plates.	SSA-F-2.2.1	2CKA006220A0125	1

### Sensor & dimmer actuators

Product	Article-No.	Order-No.	Pack/Qty
 free@home sensor/Dimmer actuator - 1/1-gang For dimming 230 V~ loads. With integrated universal dimming actuator for controlling different lamps. The dimming function is available pre-configured. Outputs: 1x dimming channel. Suitable for: 230 V incandescent lamps and low-voltage halogen lamps with conventional transformers or electronic transformers. Rated power: 10-180 W / VA. Suitable for: LEDi and energy-saving bulbs. Rated power: 2-80 W / VA. Mounting depth: 32 mm. To be installed with SR-1-85, SRL-1-85, SRD-1-85, SRB-1-85 and SRS-1-85 cover plates.	SDA-F-1.1.1	2CKA006220A0126	1
 free@home Sensor/Dimmer actuator - 2/1-gang For dimming 230 V~ loads. With integrated universal dimming actuator for controlling different lamps. The dimming function is available pre-configured. Outputs: 1x dimming channel. Suitable for: 230 V incandescent lamps and low-voltage halogen lamps with conventional transformers or electronic transformers. Rated power: 10-180 W / VA. Suitable for: LEDi and energy-saving bulbs. Rated power: 2-80 W / VA. Mounting depth: 32 mm. To be installed with SR-2-85, SRL-2-L-85 SRL-2-R-85, SRD-2-L-85, SRD-2-R-85, SRB-2-85 SRS-2-L-85 and SRS-2-R-85 cover plates.	SDA-F-2.1.1	2CKA006220A0127	1

### Sensor & blind actuators

Product	Article-No.	Order-No.	Pack/Qty
 free@home Sensor/Blind actuator - 1/1-gang For controlling blind and awning motors. With integrated blind actuator. Blind function is available pre-configured. Outputs: 1x Change-over contacts/normally open contact, potential-bound. Rated power: 920 VA. Rated current: 4 A. Suitable for: Operating mode blind. Mounting depth: 32 mm. To be installed with SR-1-85, SRL-1-85, SRD-1-85, SRB-1-85 and SRS-1-85 cover plates.	SBA-F-1.1.1	2CKA006220A0128	1
 free@home Sensor/Blind actuator - 2/1-gang For controlling blind and awning motors. With integrated blind actuator. Blind function is available pre-configured. Outputs: 1x Change-over contacts/normally open contact, potential-bound. Rated power: 920 VA. Rated current: 4 A. Suitable for: Operating mode blind. Mounting depth: 32 mm. To be installed with SR-2-85, SRL-2-L-85 SRL-2-R-85, SRD-2-L-85, SRD-2-R-85, SRB-2-85 SRS-2-L-85 and SRS-2-R-85 cover plates.	SBA-F-2.1.1	2CKA006220A0129	1

## Sky Niessen - Free@home - Home automation

### Room temperature controller

Product	Article-No.	Order-No.	Pack/Qty
	<b>free@home Room temperature controller</b> Control element with room temperature control function for controlling commercially available actuating drives or analogue actuating drives (continuous controllers), as well as fan coils. With display of setvalue temperature. Display elements: LCD Display showing operation modes. Mounting depth: 14 mm. To be installed with CP-RTC-85 cover plates for RTC or CP-RTC-FC-85 cover plates for fan coil control.		
	<b>RTC-F-1</b>	2CKA006220A0122	1

### Motion sensor & actuators

Product	Article-No.	Order-No.	Pack/Qty
	<b>free@home 180° motion sensor</b> With select lens for detection with animal access. For automatic switching of ABB-free@home® actuators dependent on movement and brightness. To be used with. Detection range: frontal 6 m, lateral 3 m. Detection angle: 180°. Brightness limit value: 1 – 500 lux. Protection class of device: IP 20. Mounting depth: 14.1 mm. To be installed with CP-MD-85 cover plates (mounting grid without claws included).		
	<b>MD-F-1.0.PB.1</b>	2CKA006220A0229	1

	<b>free@home 180° motion sensor/actuator</b> With select lens for detection with animal access. Including an integrated actuator for switching 230 V~ devices. Outputs: 1x normally open contact, potential free. Suitable for: resistive. Rated current: 10 A. Rated power: 2300 W. Suitable for: capacitive. Rated current: 10 AX. Detection range: frontal 6 m, lateral 3 m. Detection angle: 180°. Brightness limit value: 1 – 500 lux. Protection class of device: IP 20. Mounting depth: 31.5 mm. To be installed with CP-MD-85 cover plates (mounting grid without claws included).		
	<b>MSA-F-1.1.PB.1</b>	2CKA006220A0231	1

### Wireless sensors

Product	Article-No.	Order-No.	Pack/Qty
	<b>free@home Sensor unit - 1-gang - Wireless</b> Rated voltage: 230 Vac - 50/60Hz. For transmitting switching, push-button, dimming and blind commands to an ABB-free@home® actuator. Wireless communication with the free@home system. With fixing claws. Control element: switch contacts top/bottom. Display elements: LED as light for orientation or display of the switching state. Temperature range device: -5 °C to 45 °C. Mounting depth: 32 mm. To be installed with SR-1-85 cover plates.		
	<b>SU-F-1.0.1-WL</b>	2CKA006200A0072	1

	<b>free@home Sensor unit - 2-gang - Wireless</b> Rated voltage: 230 Vac - 50/60Hz. For transmitting switching, push-button, dimming and blind commands to an ABB-free@home® actuator. Wireless communication with the free@home system. With fixing claws. Control element: switch contacts top/bottom. Display elements: LED as light for orientation or display of the switching state. Temperature range device: -5 °C to 45 °C. Mounting depth: 32 mm. To be installed with SR-2-85 cover plates.		
	<b>SU-F-2.0.1-WL</b>	2CKA006200A0073	1

	<b>free@home Sensor/Switch actuator - 1/1-gang - Wireless</b> Rated voltage: 230 Vac - 50/60Hz. For switching 230 V~ consumers. Wireless communication with the free@home system. With integrated switch actuator. Switching function is available also without prior programming (pre-configured). Configuration can be changed later via the web interface (groups, scenes, etc.). 3 wire connection (neutral conductor required). With 230 V extension unit input (On/Off). With fixing claws. Control element: switch contacts top/bottom. Display elements: LED as light for orientation or display of the switching state. Outputs: 1 Normally Open contact, potential-bound (output voltage: 230 Vac) Suitable for: ohmic. Rated current / power: 10 A / 2300 W. Suitable for: capacitive. Rated current / power: 10 AX / 2300 VA. Suitable for: inductive. Rated current / power: 10 A / 2300 VA. Temperature range device: -5 °C to 45 °C. Mounting depth: 32 mm. To be installed with SR-1-85 cover plates.		
	<b>SSA-F-1.1.1-WL</b>	2CKA006200A0074	1



## Sky Niessen - Free@home - Home automation

### Wireless sensor & switch actuators

Product	Article-No.	Order-No.	Pack/Qty
 <p>free@home Sensor/Switch actuator - 2/1-gang - Wireless            Rated voltage: 230 Vac - 50/60Hz.            For switching 230 V~ consumers.            Wireless communication with the free@home system.            With integrated switch actuator. Switching function is available also without prior programming (pre-configured).            Configuration can be changed later via the web interface (groups, scenes, etc.). The right sensor channel for programming additional functions (groups, scenes, etc.).            3 wire connection (neutral conductor required).            With 230 V extension unit input (On/Off).            With fixing claws.            Control element: switch contacts top/bottom.            Display elements: LED as light for orientation or display of the switching state.            Outputs: 1 Normally Open contact, potential-bound (output voltage: 230 Vac).            Suitable for: ohmic.            Rated current / power: 10 A / 2300 W.            Suitable for: capacitive.            Rated current / power: 10 AX / 2300 VA.            Suitable for: inductive.            Rated current / power: 10 A / 2300 VA.            Temperature range device: -5 °C to 45 °C.            Mounting depth: 32 mm.            To be installed with SR-2-85 cover plates.</p>	SSA-F-2.1.1-WL	2CKA006200A0075	1

 <p>free@home Sensor/Switch actuator - 2/2-gang - Wireless            Rated voltage: 230 Vac - 50/60Hz.            For switching 230 V~ consumers.            Wireless communication with the free@home system.            With integrated 2-gang switch actuator. Switching function is available also without prior programming (pre-configured).            Configuration can be changed later via the web interface (groups, scenes, etc.). The right sensor channel for programming additional functions (groups, scenes, etc.).            3 wire connection (neutral conductor required).            With two 230 V extension unit inputs (On/Off).            With fixing claws.            Control element: switch contacts top/bottom            Display elements: LED as light for orientation or display of the switching state.            Outputs: 2 Normally Open contacts, potential-bound (output voltage: 230 Vac).            Suitable for: ohmic.            Rated current / power: 5 A / 1200 W.            Suitable for: capacitive.            Rated power: 920 VA.            Suitable for: inductive.            Rated power: 800 VA.            Temperature range device: -5 °C to 45 °C.            Mounting depth: 32 mm.            To be installed with SR-2-85 cover plates.</p>	SSA-F-2.2.1-WL	2CKA006200A0076	1
--	----------------	-----------------	---

### Wireless sensor & dimmer actuators

Product	Article-No.	Order-No.	Pack/Qty
 <p>free@home Sensor/Dimmer actuator - 1/1-gang - Wireless            Rated voltage: 230 Vac - 50/60Hz.            For dimming 230 V~ loads.            Wireless communication with the free@home system.            With integrated universal dimming actuator for controlling LEDs, incandescent lamps, 230 V halogen lamps, lowvoltage halogen lamps with conventional or electronic transformers, and dimmable energy-saving halogen lamps. For dimmable Retrofit-LEDs (LEDi).            Dimming function is available also without prior programming (pre-configured). Configuration can be changed later via the web interface (groups, scenes, etc.).            2-wire connection (neutral conductor not required)            3-wire connection technology is possible as an option for improved load behaviour (for details see the manual).            With 230 V extension unit input (dimming brighter/darker, switching).            With fixing claws.            Control element: switch contacts top/bottom.            Display elements: LED as light for orientation or display of the switching state.            Outputs: 1 dimming channel.            Suitable for: 230 V incandescent lamps and low-voltage halogen lamps with conventional transformers or electronic transformer.            Rated power: 20 - 180 W / VA.            Suitable for: LEDi and energy-saving bulbs; typical.            Rated power: 2 - 80 W / VA.            Temperature range device: -5 °C to 45 °C.            Mounting depth: 32 mm.            To be installed with SR-1-85 cover plates.</p>	SDA-F-1.1.1-WL	2CKA006200A0077	1

 <p>free@home Sensor/Dimmer actuator - 2/1-gang - Wireless            Rated voltage: 230 Vac - 50/60Hz.            For dimming 230 V~ loads.            Wireless communication with the free@home system.            With integrated universal dimming actuator for controlling LEDs, incandescent lamps, 230 V halogen lamps, lowvoltage halogen lamps with conventional or electronic transformers, and dimmable energy-saving halogen lamps. For dimmable Retrofit-LEDs (LEDi). Dimming function is available also without prior programming (left sensor channel is pre-configured). Configuration can be changed later via the web interface (groups, scenes, etc.). The right sensor channel for programming additional functions (groups, scenes, etc.).            2-wire connection (neutral conductor not required)            3-wire connection technology is possible as an option for improved load behaviour (for details see the manual).            With 230 V extension unit input (dimming brighter/darker, switching).            With fixing claws.            Control element: switch contacts top/bottom            Display elements: LED as light for orientation or display of the switching state.            Outputs: 1 dimming channel.            Suitable for: 230 V incandescent lamps and low-voltage halogen lamps with conventional transformers or electronic transformer.            Rated power: 20 - 180 W / VA.            Suitable for: LEDi and energy-saving bulbs; typical.            Rated power: 2 - 80 W / VA.            Temperature range device: -5 °C to 45 °C.            Mounting depth: 32 mm.            To be installed with SR-2-85 cover plates.</p>	SDA-F-2.1.1-WL	2CKA006200A0078	1
--	----------------	-----------------	---

## Sky Niessen - Free@home - Home automation

### Wireless sensor & blind actuators

Product	Article-No.	Order-No.	Pack/Qty
	free@home Sensor/Blind actuator - 1/1-gang - Wireless Rated voltage: 230 Vac - 50/60Hz. For controlling blind or awning motors. Wireless communication with the free@home system. With integrated blind actuator. Blind function is available also without prior programming (pre-configured). Configuration can be changed later via the web interface (groups, scenes, etc.). 3 wire connection (neutral conductor required). With two 230 V extension unit inputs (Up/Down). With fixing claws. Control element: switch contacts top/bottom. Display elements: LED as light for orientation or display of the switching state. Outputs: 2 Normally Open contact, potential-bound (output voltage: 230 Vac). Suitable for: blind motors. Rated current / power: 4 A / 920 VA. Temperature range device: -5 °C to 45 °C. Mounting depth: 32 mm. To be installed with SR-1-85 cover plates.		
	<b>SBA-F-1.1.1-WL</b>	2CKA006200A0079	1

	free@home Sensor/Blind actuator - 2/1-gang - Wireless Rated voltage: 230 Vac - 50/60Hz. For controlling blind or awning motors. Wireless communication with the free@home system. With integrated blind actuator. Blind function is available also without prior programming (pre-configured). Configuration can be changed later via the web interface (groups, scenes, etc.). The right sensor channel for programming additional functions (groups, scenes, etc.). 3 wire connection (neutral conductor required). With two 230 V extension unit inputs (Up/Down). With fixing claws. Control element: switch contacts top/bottom. Display elements: LED as light for orientation or display of the switching state. Outputs: 2 Normally Open contacts, potential-bound (output voltage: 230 Vac). Suitable for: blind motors. Rated current / power: 4 A / 920 VA. Temperature range device: -5 °C to 45 °C. Mounting depth: 32 mm. To be installed with SR-2-85 cover plates.		
	<b>SBA-F-2.1.1-WL</b>	2CKA006200A0080	1

### Wireless temperature controller

Product	Article-No.	Order-No.	Pack/Qty
	free@home Room thermostat - Wireless Rated voltage: 230 Vac - 50/60Hz. Heating/cooling operation. Wireless communication with the free@home system. Control element with room temperature controller function. With display of set-value temperature. In connection with temperature sensor 6226/T the integrated room temperature controller can be fitted with a remote sensor. With fixing claws. Control element: floating rocker for the selection of set values and operating modes. Display elements: LCD showing operation modes. Temperature range device: -5 °C to 45 °C. Mounting depth: 32 mm. To be installed with CP-RTC-85 cover plates for RTC or CP-RTC-FC-85 for fan coil control.		
	<b>RTC-F-1-WL</b>	2CKA006200A0081	1

	free@home Room thermostat/actuator - Wireless Rated voltage: 230 Vac - 50/60Hz. Rated frequency: 50 Hz / 60 Hz. Heating/cooling operation. Wireless communication with the free@home system. Control element with room temperature controller function. With display of set-value temperature. With integrated switch actuator, e.g. for controlling thermoelectric actuating drives in heating/cooling systems or electric floor heating systems. RTC function is available also without prior programming (pre-configured). In connection with temperature sensor 6226/T the integrated room temperature controller can be fitted with a remote sensor. 3 wire connection (neutral conductor required). With fixing claws. Control element: floating rocker for the selection of set values and operating modes. Display elements: LCD showing operation modes. Outputs: 1 Normally Open contact, potential-bound (output voltage: 230 Vac). Suitable for: ohmic. Rated current / power: 16 A / 3680 W. Temperature range device: -5 °C to 45 °C. Mounting depth: 32 mm. To be installed with CP-RTC-85 cover plates.		
	<b>RTC-F-2.1.1-WL</b>	2CKA006200A0082	1

## Sky Niessen - Free@home - Home automation

### Cover plates

Color	Article-No.	Order-No.	Pack/Qty
	Cover plate - free@home 1-gang sensors Cover plate for free@home sensors and sensor/ actuators with 1-gang sensors code: SU-F-1.0.1, SSA-F-1.1.1, SDA-F-1.1.1, SBA-F-1.1.1, SU-F-1.0.1-WL, SSA-F-1.1.1-WL, SDA-F-1.1.1-WL, SBA-F-1.1.1-WL. Without symbol.		
Soft White	<b>SR-1-85 BL</b>	2CLA852620A1101	1
Silver	<b>SR-1-85 PL</b>	2CLA852620A1301	1
Soft Black	<b>SR-1-85 NS</b>	2CLA852620A1501	1
Stainless Steel	<b>SR-1-85 AI</b>	2CLA852620A1401	1
Antique Gold	<b>SR-1-85 OE</b>	2CLA852620A1201	1

	Cover plate - free@home 1-gang sensors - Switch Cover plate for free@home sensors and sensor/ actuators with 1-gang sensors code: SU-F-1.0.1, SSA-F-1.1.1, SDA-F-1.1.1, SBA-F-1.1.1, SU-F-1.0.1-WL, SSA-F-1.1.1-WL, SDA-F-1.1.1-WL, SBA-F-1.1.1-WL. With Light symbol.		
Soft White	<b>SRL-1-85 BL</b>	2CLA852626A1101	1
Silver	<b>SRL-1-85 PL</b>	2CLA852626A1301	1
Soft Black	<b>SRL-1-85 NS</b>	2CLA852626A1501	1
Stainless Steel	<b>SRL-1-85 AI</b>	2CLA852626A1401	1
Antique Gold	<b>SRL-1-85 OE</b>	2CLA852626A1201	1

	Cover plate - free@home 1-gang sensors - Dimmer Cover plate for free@home sensors and sensor/ actuators with 1-gang sensors code: SU-F-1.0.1, SSA-F-1.1.1, SDA-F-1.1.1, SBA-F-1.1.1, SU-F-1.0.1-WL, SSA-F-1.1.1-WL, SDA-F-1.1.1-WL, SBA-F-1.1.1-WL. With Dimming symbol.		
Soft White	<b>SRD-1-85 BL</b>	2CLA852625A1101	1
Silver	<b>SRD-1-85 PL</b>	2CLA852625A1301	1
Soft Black	<b>SRD-1-85 NS</b>	2CLA852625A1501	1
Stainless Steel	<b>SRD-1-85 AI</b>	2CLA852625A1401	1
Antique Gold	<b>SRD-1-85 OE</b>	2CLA852625A1201	1

	Cover plate - free@home 1-gang sensors - Blind Cover plate for free@home sensors and sensor/ actuators with 1-gang sensors code: SU-F-1.0.1, SSA-F-1.1.1, SDA-F-1.1.1, SBA-F-1.1.1, SU-F-1.0.1-WL, SSA-F-1.1.1-WL, SDA-F-1.1.1-WL, SBA-F-1.1.1-WL. With Blind symbol.		
Soft White	<b>SRB-1-85 BL</b>	2CLA852623A1101	1
Silver	<b>SRB-1-85 PL</b>	2CLA852623A1301	1
Soft Black	<b>SRB-1-85 NS</b>	2CLA852623A1501	1
Stainless Steel	<b>SRB-1-85 AI</b>	2CLA852623A1401	1
Antique Gold	<b>SRB-1-85 OE</b>	2CLA852623A1201	1

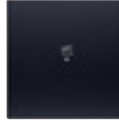
Color	Article-No.	Order-No.	Pack/Qty
	Cover plate - free@home 1-gang sensors - Scene Cover plate for free@home sensors and sensor/ actuators with 1-gang sensors code: SU-F-1.0.1, SSA-F-1.1.1, SDA-F-1.1.1, SBA-F-1.1.1, SU-F-1.0.1-WL, SSA-F-1.1.1-WL, SDA-F-1.1.1-WL, SBA-F-1.1.1-WL. With Scene symbol.		
Soft White	<b>SRS-1-85 BL</b>	2CLA852627A1101	1
Silver	<b>SRS-1-85 PL</b>	2CLA852627A1301	1
Soft Black	<b>SRS-1-85 NS</b>	2CLA852627A1501	1
Stainless Steel	<b>SRS-1-85 AI</b>	2CLA852627A1401	1
Antique Gold	<b>SRS-1-85 OE</b>	2CLA852627A1201	1

	Cover plate - free@home 2-gang sensors Cover plate for free@home sensors and sensor/ actuators with 2-gang sensors code: SU-F-2.0.1, SSA-F-2.1.1, SSA-F-2.2.1, SDA-F-2.1.1, SBA-F-2.1.1, SU-F-2.0.1-WL, SSA-F-2.1.1-WL, SSA-F-2.2.1-WL, SDA-F- 2.1.1-WL, SBA-F-2.1.1-WL. Without symbol. Suitable for both gangs.		
Soft White	<b>SR-2-85 BL</b>	2CLA852640A1101	1
Silver	<b>SR-2-85 PL</b>	2CLA852640A1301	1
Soft Black	<b>SR-2-85 NS</b>	2CLA852640A1501	1
Stainless Steel	<b>SR-2-85 AI</b>	2CLA852640A1401	1
Antique Gold	<b>SR-2-85 OE</b>	2CLA852640A1201	1

	Cover plate - free@home 2-gang sensors - Switch - Left Cover plate for free@home sensors and sensor/ actuators with 2-gang sensors code: SU-F-2.0.1, SSA-F-2.1.1, SSA-F-2.2.1, SDA-F-2.1.1, SBA-F-2.1.1, SU-F-2.0.1-WL, SSA-F-2.1.1-WL, SSA-F-2.2.1-WL, SDA-F- 2.1.1-WL, SBA-F-2.1.1-WL. With Light symbol. Suitable for the left gang.		
Soft White	<b>SRL-2-L-85 BL</b>	2CLA852642A1101	1
Silver	<b>SRL-2-L-85 PL</b>	2CLA852642A1301	1
Soft Black	<b>SRL-2-L-85 NS</b>	2CLA852642A1501	1
Stainless Steel	<b>SRL-2-L-85 AI</b>	2CLA852642A1401	1
Antique Gold	<b>SRL-2-L-85 OE</b>	2CLA852642A1201	1

	Cover plate - free@home 2-gang sensors - Switch - Right Cover plate for free@home sensors and sensor/ actuators with 2-gang sensors code: SU-F-2.0.1, SSA-F-2.1.1, SSA-F-2.2.1, SDA-F-2.1.1, SBA-F-2.1.1, SU-F-2.0.1-WL, SSA-F-2.1.1-WL, SSA-F-2.2.1-WL, SDA-F- 2.1.1-WL, SBA-F-2.1.1-WL. With Light symbol. Suitable for the right gang.		
Soft White	<b>SRL-2-R-85 BL</b>	2CLA852648A1101	1
Silver	<b>SRL-2-R-85 PL</b>	2CLA852648A1301	1
Soft Black	<b>SRL-2-R-85 NS</b>	2CLA852648A1501	1
Stainless Steel	<b>SRL-2-R-85 AI</b>	2CLA852648A1401	1
Antique Gold	<b>SRL-2-R-85 OE</b>	2CLA852648A1201	1

# Sky Niessen - Free@home - Home automation

## Cover plates

Color	Article-No.	Order-No.	Pack/Qty
	<b>Cover plate - free@home 2-gang sensors - Dimmer - Left</b> Cover plate for free@home sensors and sensor/actuators with 2-gang sensors code: SU-F-2.0.1, SSA-F-2.1.1, SSA-F-2.2.1, SDA-F-2.1.1, SBA-F-2.1.1, SU-F-2.0.1-WL, SSA-F-2.1.1-WL, SSA-F-2.2.1-WL, SDA-F-2.1.1-WL, SBA-F-2.1.1-WL. With Dimming symbol. Suitable for the left gang.		
Soft White	<b>SRD-2-L-85 BL</b>	2CLA852641A1101	1
Silver	<b>SRD-2-L-85 PL</b>	2CLA852641A1301	1
Soft Black	<b>SRD-2-L-85 NS</b>	2CLA852641A1501	1
Stainless Steel	<b>SRD-2-L-85 AI</b>	2CLA852641A1401	1
Antique Gold	<b>SRD-2-L-85 OE</b>	2CLA852641A1201	1

	<b>Cover plate - free@home 2-gang sensors - Dimmer - Right</b> Cover plate for free@home sensors and sensor/actuators with 2-gang sensors code: SU-F-2.0.1, SSA-F-2.1.1, SSA-F-2.2.1, SDA-F-2.1.1, SBA-F-2.1.1, SU-F-2.0.1-WL, SSA-F-2.1.1-WL, SSA-F-2.2.1-WL, SDA-F-2.1.1-WL, SBA-F-2.1.1-WL. With Dimming symbol. Suitable for the right gang. Suitable for both gangs.		
Soft White	<b>SRD-2-R-85 BL</b>	2CLA852640A2101	1
Silver	<b>SRD-2-R-85 PL</b>	2CLA852640A2301	1
Soft Black	<b>SRD-2-R-85 NS</b>	2CLA852640A2501	1
Stainless Steel	<b>SRD-2-R-85 AI</b>	2CLA852640A2401	1
Antique Gold	<b>SRD-2-R-85 OE</b>	2CLA852640A2201	1

	<b>Cover plate - free@home 2-gang sensors - Blind</b> Cover plate for free@home sensors and sensor/actuators with 2-gang sensors code: SU-F-2.0.1, SSA-F-2.1.1, SSA-F-2.2.1, SDA-F-2.1.1, SBA-F-2.1.1, SU-F-2.0.1-WL, SSA-F-2.1.1-WL, SSA-F-2.2.1-WL, SDA-F-2.1.1-WL, SBA-F-2.1.1-WL. With Blind symbol. Suitable for both gangs.		
Soft White	<b>SRB-2-85 BL</b>	2CLA852643A1101	1
Silver	<b>SRB-2-85 PL</b>	2CLA852643A1301	1
Soft Black	<b>SRB-2-85 NS</b>	2CLA852643A1501	1
Stainless Steel	<b>SRB-2-85 AI</b>	2CLA852643A1401	1
Antique Gold	<b>SRB-2-85 OE</b>	2CLA852643A1201	1

	<b>Cover plate - free@home 2-gang sensors - Scene - Left</b> Cover plate for free@home sensors and sensor/actuators with 2-gang sensors code: SU-F-2.0.1, SSA-F-2.1.1, SSA-F-2.2.1, SDA-F-2.1.1, SBA-F-2.1.1, SU-F-2.0.1-WL, SSA-F-2.1.1-WL, SSA-F-2.2.1-WL, SDA-F-2.1.1-WL, SBA-F-2.1.1-WL. With Scene symbol. Suitable for the left gang.		
Soft White	<b>SRS-2-L-85 BL</b>	2CLA852644A1101	1
Silver	<b>SRS-2-L-85 PL</b>	2CLA852644A1301	1
Soft Black	<b>SRS-2-L-85 NS</b>	2CLA852644A1501	1
Stainless Steel	<b>SRS-2-L-85 AI</b>	2CLA852644A1401	1
Antique Gold	<b>SRS-2-L-85 OE</b>	2CLA852644A1201	1

Color	Article-No.	Order-No.	Pack/Qty
	<b>Cover plate - free@home 2-gang sensors - Scene - Right</b> Cover plate for free@home sensors and sensor/actuators with 2-gang sensors code: SU-F-2.0.1, SSA-F-2.1.1, SSA-F-2.2.1, SDA-F-2.1.1, SBA-F-2.1.1, SU-F-2.0.1-WL, SSA-F-2.1.1-WL, SSA-F-2.2.1-WL, SDA-F-2.1.1-WL, SBA-F-2.1.1-WL. With Scene symbol. Suitable for the right gang.		
Soft White	<b>SRS-2-R-85 BL</b>	2CLA852647A1101	1
Silver	<b>SRS-2-R-85 PL</b>	2CLA852647A1301	1
Soft Black	<b>SRS-2-R-85 NS</b>	2CLA852647A1501	1
Stainless Steel	<b>SRS-2-R-85 AI</b>	2CLA852647A1401	1
Antique Gold	<b>SRS-2-R-85 OE</b>	2CLA852647A1201	1

	<b>Cover plate - free@home RTC</b> Cover plate with RTC symbols for free@home room temperature controller code: RTC-F-1, RTC-F-1-WL and RTC-F-2.1.1-WL.		
Soft White	<b>CP-RTC-85 BL</b>	2CLA854060A1101	1
Silver	<b>CP-RTC-85 PL</b>	2CLA854060A1301	1
Soft Black	<b>CP-RTC-85 NS</b>	2CLA854060A1501	1
Stainless Steel	<b>CP-RTC-85 AI</b>	2CLA854060A1401	1
Antique Gold	<b>CP-RTC-85 OE</b>	2CLA854060A1201	1

	<b>Cover plate - free@home fan coil control</b> Cover plate with fan coil control symbols for free@home room temperature controller code: RTC-F-1 and RTC-F-1-WL.		
Soft White	<b>CP-RTC-FC-85 BL</b>	2CLA855420A1101	1
Silver	<b>CP-RTC-FC-85 PL</b>	2CLA855420A1301	1
Soft Black	<b>CP-RTC-FC-85 NS</b>	2CLA855420A1501	1
Stainless Steel	<b>CP-RTC-FC-85 AI</b>	2CLA855420A1401	1
Antique Gold	<b>CP-RTC-FC-85 OE</b>	2CLA855420A1201	1

	<b>Cover plate - free@home motion sensor</b> Cover plate for free@home motion sensors and sensor/actuators code: MD-F-1.0.PB.1 and MSA-F.1.1.PB.1.		
Soft White	<b>CP-MD-85 BL</b>	2CLA854160A1101	1
Silver	<b>CP-MD-85 PL</b>	2CLA854160A1301	1
Soft Black	<b>CP-MD-85 NS</b>	2CLA854160A1501	1
Stainless Steel	<b>CP-MD-85 AI</b>	2CLA854160A1401	1
Antique Gold	<b>CP-MD-85 OE</b>	2CLA854160A1201	1



## Sky Niessen



### Touch displays

Color	Article-No.	Order-No.	Pack/Qty
	<b>ABB-free@homeTouch 7"</b> For the central control of up to 16 configurable ABB-free@home® functions of type: switching, dimming, blind, RTC, scene, Philips HUE. Display of the video image of the outdoor station of ABB-Welcome door entry system. Suitable as room temperature controller extension unit (up to 8). Surface mounting. The bus can be connected via enclosed terminal block. Display size / resolution: 17.8 cm (7") / 800 x 480 Consumer units: 11 Display elements: TFT Touch Display Dimensions: (L x W x D): 155 mm x 218 mm x 29 mm Programming only with bus voltage applied via the web interface of the System Access Point. The power is supplied by the ABB-Welcome system controller or when using the ABB-free@home panel without an ABB-Welcome system, a separate ABB 24 V- power supply is required. Protection class (device): IP30 Temperature range (device): -5 °C to 40 °C		
White	<b>DP7-S-611</b>	2CKA008300A0356	1
Black	<b>DP7-S-625</b>	2CKA008300A0357	1



**ABB-free@homeTouch 4.3"**  
For the central control of up to 16 configurable ABB-free@home® functions.  
For the display of configurable system messages. A configurable primary function can be triggered with a multi-touch gesture.  
Capacitive touch screen with closed glass surface.  
With integrated room temperature controller and temperature sensor.  
In connection with temperature sensor 6226/T the integrated room temperature controller can be fitted with a remote sensor.  
Suitable as room temperature controller extension unit (up to 8).  
Requires additional ABB power supply 24 VDC.  
Display size / resolution: 10.9 cm (4.3") / 480 x 854.  
Mounting height: 8 mm  
Control element: freely programmable touch surfaces.  
Display elements: LCD display  
Bus voltage: 24 V-  
Dimensions: (L x W x D): 104 mm x 143 mm x 53 mm  
Programming only with bus voltage applied via the web interface of the System Access Point.  
Protection class (device): IP20  
Temperature range (device): -5 °C to 40 °C

White	<b>DP4-1-611</b>	2CKA006220A0119	1
Black	<b>DP4-1-625</b>	2CKA006220A0120	1

Color	Article-No.	Order-No.	Pack/Qty
	<b>Flush mounting installation box</b> For flush-mounted in hollow-wall installation of the ABB-free@homeTouch 4.3". Windproof. Installation dimensions (H x W x D): 82 mm x 123 mm x 50 mm Mounting depth: 50 mm Halogen free.		
	<b>DP4-F</b>	2CKA006220A0389	1
	<b>Temperature sensor</b> For use as remote sensor with ABB-free@homeTouch 4.3". Line type: H03 VV-F Cable length: 4 m Type: NTC 10 kohm.		
	<b>DP4-T-1</b>	2CKA006220A0721	1

## Sky Niessen

### System Access Point

Product	Article-No.	Order-No.	Pack/Qty
	<b>System Access Point - Wireless</b> For commissioning and remote control of the ABB-free@home® system. With integrated free@home wireless antenna. With integrated free@home bus connection. Allows the execution of astro and time programs. Commissioning and remote control is executed via the web interface or app. No additional commissioning software is required. Easy commissioning with WLAN ad-hoc mode. WLAN modes switchable via local operation. Connection to the home network via WLAN client mode or via CAT cable. The bus connection is provided via the enclosed bus terminal. Display elements: LED for status display. Rated voltage: 230 V~; 50/60 Hz. Bus voltage: 24 V. Dimensions: (L x W x D): 110 mm x 170 mm x 31 mm Programming via the web interface of the System Access Point. Protection class (device): IP20 Temperature range (device): -5 °C to 45 °C		
<b>SAP-S-2</b>		2CKA006200A0105	1

	<b>External antenna - Wireless</b> For use with System Access Point SAP-S-2 and SAP-S-127.2. Feed the free@home wireless signal to the outside when the internal antenna of the System Access Point is shielded due to structural conditions. With magnetic base. Cable length: 1.5 m		
<b>SAP-1-WL</b>		2CKA006200A0100	1

### Weather station



Product	Article-No.	Order-No.	Pack/Qty
	<b>Weather station</b> For recording and transmitting of brightness, temperature, wind speed and rain. Weather data can be linked with actuators to automatically control functions. Weather data can be visualized in the free@home web interface and the free@home app. Wind speed measuring range 2 - 30 m/s The bus can be connected via enclosed terminal block. Rated voltage: 110 V~ - 230 V~; 50/60 Hz. Bus voltage: 24 V- Inputs: 4 Temperature range (sensor): Brightness limit value: 1 lux - 10000 lux Dimensions: (L x W x D): 108 mm x 121 mm x 227 mm Protection class (device): IP44 Temperature range (device): -20 °C to 55 °C		
<b>WS-1</b>		2CKA006220A0390	1

### Power supply



Product	Article-No.	Order-No.	Pack/Qty
	<b>Power supply</b> Power supply with integrated choke. Fast diagnosis due to LED display for operational readiness and errors. The bus can be connected via enclosed terminal block. Display elements: operational load/overload LED Rated voltage: 127 V~ - 230 V~, +10 % / -15 %; 50/60Hz Secondary: 30 V, +2 V / -2 V Outputs: 1 Rated current: 640 mA Protection class (device): IP20 Temperature range (device): -5 °C to 45 °C Dimensions: (L x W x D): 90 mm x 72 mm x 64 mm Module width (DIN-rail): 4 MW		
<b>PS-M-64.1.1</b>		2CDG510001R0011	1

## Sky Niessen

### Binary inputs

Product	Article-No.	Order-No.	Pack/Qty
	<b>Binary input 2-gang</b> Conventional push-buttons or auxiliary contacts can be connected to 2 channels. The information of the contact scanning can be used for activating ABB-free@home® actuators or for recording status information. The contact polling voltage is made available from the binary input itself. Extension of the connecting cables possible by a maximum of 10 m. Flush-mounted device for installation in a 60 mm device box or distribution box. The bus can be connected via enclosed terminal block. Programming only with bus voltage applied via the web interface of the System Access Point. Bus voltage: 24 V Inputs: 2 Polling voltage: 20 V- Protection class (device): IP20 Temperature range (device): -5 °C to 45 °C Dimensions: (L x W x D): 39 mm x 40 mm x 12 mm.		
	<b>BI-F-2.0.1</b>	2CDG510002R0011	1
	<b>Binary input 4-gang</b> Conventional push-buttons or auxiliary contacts can be connected to 4 channels. The information of the contact scanning can be used for activating ABB-free@home® actuators or for recording status information. The contact polling voltage is made available from the binary input itself. Extension of the connecting cables possible by a maximum of 10 m. Flush-mounted device for installation in a 60 mm device box or distribution box. The bus can be connected via enclosed terminal block. Programming only with bus voltage applied via the web interface of the System Access Point. Bus voltage: 24 V Inputs: 4 Polling voltage: 20 V- Protection class (device): IP20 Temperature range (device): -5 °C to 45 °C Dimensions: (L x W x D): 39 mm x 40 mm x 12 mm		
	<b>BI-F-4.0.1</b>	2CDG510003R0011	1
	<b>Binary input 4-gang</b> The device detects AC/DC signals of 10 - 230 V via 4 channels. The information of the signal evaluation can be used for controlling ABB-free@home® actuators or for recording status information. The bus can be connected via enclosed terminal block. Programming only with bus voltage applied via the web interface of the System Access Point. Bus voltage: 24 V Inputs: 4 Protection class (device): IP20 Temperature range (device): -5 °C to 45 °C Dimensions: (L x W x D): 90 mm x 36 mm x 64 mm Module width DIN-rail): 2 MW		
	<b>BI-M-4.0.1</b>	2CDG510004R0011	1

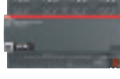
## Switch actuators

Product	Article-No.	Order-No.	Pack/Qty
	<b>Binary input 8-gang / switch actuator 8-gang</b> Combination device with 8 binary inputs and 8 switch actuators. Conventional push-buttons or auxiliary contacts can be connected to 8 channels. The information of the contact scanning can be used for activating ABB-free@home® actuators or for recording status information. The contact polling voltage is made available by the device itself. Maximum cable length at a cable cross-section of 1.5 mm <sup>2</sup> < 100 m. For switching 8 independent 230 V~ loads. No additional commissioning software is required. Programming only with bus voltage applied via the web interface of the System Access Point. Bus voltage: 24 V Inputs: 8 Polling voltage: 35 V- Outputs: 8 Normally Open contact, potential free Suitable for: AC1 (Output voltage: 230 V~) Rated current: 6 A, cos φ 0.8 Suitable for: AC3 (Output voltage: 230 V~) Rated current: 6 A, cos φ 0.45 Protection class (device): IP20 Temperature range (device): -5 °C to 45 °C Dimensions: (L x W x D): 90 mm x 144 mm x 64.5 mm Module width (DIN-rail): 8 MW.		
	<b>SA-M-8.8.1</b>	2CDG510007R0011	1
	<b>Switch actuator 4-gang</b> For switching 4 independent 127 V~/230 V~ loads. Each contact has a manual operation function independent of auxiliary voltage for additionally displaying the contact setting. The bus can be connected via enclosed terminal block. Control element: relay control element. Display elements: relay control element. Programming only with bus voltage applied via the web interface of the System Access Point. Power dissipation: 4 W Bus voltage: 24 V Outputs: 4 Suitable for: AC1 (Output voltage: 230 V~) Rated current: 16 A, cos φ 0.8 Suitable for: AC3 Rated current: 8 A, cos φ 0.45 Protection class (device): IP20 Temperature range (device): -5 °C to 45 °C Dimensions: (L x W x D): 90 mm x 72 mm x 64 mm Module width (DIN-rail): 4 MW.		
	<b>SA-M-0.4.1</b>	2CDG510006R0011	1

## Sky Niessen

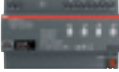

### Dimmer actuator

Product	Article-No.	Order-No.	Pack/Qty
	<b>Dimmer actuator 4-gang</b> Multi-channel universal dimming actuator for controlling LEDs, incandescent lamps, 230 V halogen lamps, low-voltage halogen lamps with conventional or electronic transformers, and dimmable energy-saving halogen lamps. For dimmable Retrofit-LEDs (LEDi). Increasing the max. load via channel bridging possible. The outputs can be switched parallel in any combination. Outputs automatically recognize the connected load. In addition, the operating mode can be selected manually. Status indication of the channels via LED. The bus can be connected via enclosed terminal block. Display elements: outputs status indication via LED. Programming only with bus voltage applied via the web interface of the System Access Point. Rated voltage: 230 V~; 50/60 Hz Bus voltage: 24 V Outputs: 4 dimming channel Suitable for: 230 V incandescent lamps and low-voltage halogen lamps with conventional transformers or electronic transformer. Rated power: 10 - 315 W/VA Suitable for: LEDi and energy-saving bulbs; typical Rated power: 2 - 80 W/VA Protection class (device): IP20 Temperature range (device): -5 °C to 45 °C Dimensions: (L x W x D): 90 mm x 144 mm x 64 mm Module width (DIN-rail): 8 MW.		
	<b>DA-M-0.4.2</b>	2CKA006220A0395	1

### Blind actuator

Product	Article-No.	Order-No.	Pack/Qty
	<b>Blind actuator 4-gang</b> For controlling 4 independent blind or roller shutter drives. The outputs are inversely blocked. The bus can be connected via enclosed terminal block. Programming only with bus voltage applied via the web interface of the System Access Point. Power dissipation: 2 W Bus voltage: 24 V Outputs: 4 Suitable for: AC3 (Output voltage: 230 V~) Rated current: 6 A, cos φ0.45 Protection class (device): IP20 Temperature range (device): -5 °C to 45 °C Dimensions: (L x W x D): 90 mm x 72 mm x 64 mm Module width (DIN-rail): 4 MW.		
	<b>BA-M-0.4.1</b>	2CDG510011R0011	1

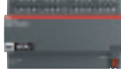
### Heating & fan coil actuators

Product	Article-No.	Order-No.	Pack/Qty
	<b>Heating actuator 6-gang</b> For controlling thermoelectric actuating drives in heating/cooling systems. The outputs are protected against short-circuit and overload. The bus can be connected via enclosed terminal block. Programming only with bus voltage applied via the web interface of the System Access Point. Power dissipation: 2 W Bus voltage: 24 V Outputs: 6 Suitable for: resistive Rated current: 160 mA Protection class (device): IP20 Temperature range (device): -5 °C to 45 °C. Dimensions: (L x W x D): 90 mm x 72 mm x 64 mm. Module width (DIN-rail): 4 MW.		
	<b>HA-M-0.6.1</b>	2CDG510008R0011	1
	<b>Heating actuator 12-gang</b> For controlling thermoelectric actuating drives in heating/cooling systems. The outputs are protected against short-circuit and overload. The bus can be connected via enclosed terminal block. Programming only with bus voltage applied via the web interface of the System Access Point. Power dissipation: 4 W Bus voltage: 24 V Outputs: 12 Suitable for: ohmic Rated current: 160 mA Protection class (device): IP20 Temperature range (device): -5 °C to 45 °C Dimensions: (L x W x D): 90 mm x 144 mm x 64 mm. Module width: 8 MW.		
	<b>HA-M-0.12.1</b>	2CDG510009R0011	1
	<b>Fan coil actuator</b> For controlling blower convectors. Supports 2-pipe and 4-pipe system for heating and cooling. The fan speed levels can be switched using a changeover or step switch function. Three contacts for switching a three-stage fan. Two contacts for activating the heating and cooling valves. Supports 24V and 230V valves. With two binary inputs for connecting dew-point and condensation contacts. The scanning voltage is provided by the device. The bus connection is provided via the enclosed bus terminal. Programming only with bus voltage applied via the web interface of the System Access Point. Bus voltage: 24 V Inputs: 2 Polling voltage: 10 V- Outputs: 3 Normally Open contact, potential free Suitable for: AC3 (Output voltage: 230 V~) Rated current: 6 A Protection class (device): IP20 Temperature range (device): -5 °C to 45 °C. Dimensions: (L x W x D): 90 mm x 108 mm x 64.5 mm. Module width (DIN-rail): 6 MW.		
	<b>FCA-M-2.3.1</b>	2CDG510010R0011	1





---

# Sky Niessen & ABB i-bus® KNX

Details and solutions for intelligent building control

**KNX brings your home to life. Convenient, safe and with foresight.**

The living room is comfortably warm on time, it stays nice and cool in the bedroom, the light matches the situation independently and the blinds adjust by themselves to the weather or time of day. Nice when comfort is easily taken for granted. With intelligent building networking from ABB.





---

**SMART BUILDING**

Rooms with intelligence. Modern building automation has become more efficient than ever in order to meet the many demands of people living and working in the building. Adaptable systems turn the modern functional building into a smart building. They create an environment in which communication and creativity can freely express themselves. Ideal for efficiency, perfect for the future.







---

# Sky Niessen KNX

## Suitable for every need

Sky Niessen is based on a combinable concept which, creating a comprehensive range, is suitable for all needs. Optimising comfort, safety and efficiency in homes and buildings. Providing comfort solutions to satisfy all types of needs and projects. Ensuring safety and protection of persons and goods. Saving energy by using only the amount of energy required.

—  
01 Switch Sensor 2gang KNX

—  
02 Switch Sensor 4gang KNX

—  
03 Busch-Watchdog 180° KNX

—  
04 Room Thermostat KNX



—  
01



—  
02



—  
03



—  
04



—  
Sky Niessen sensors  
can be customized with  
a list of specific icons:



- Multiple functions:  
switching, dimming, blinds  
sending values, scenes, etc.
- Incl. 10 logic channels
- Sequence actuator
- Logic gates
- Control element:  
switch contacts



---

**SMART BUILDING**

The perfect connection. A pleasant and productive environment is created with building automation that functions as a holistic system and combines various functions. For today and tomorrow













## Sky Niessen - KNX - Building automation

### Push-button coupler

Product	Article-No.	Order-No.	Pack/Qty
 <p><b>KNX Push-button coupler - 1/2-gang</b> For contacting conventional 1-gang rocker switches. With middle position. The bus can be connected via enclosed terminal block. To be installed with 8501 rockers.</p>	<b>6108/01-509</b>	2CKA006133A0214	1
 <p><b>KNX Push-button coupler - 2/4-gang</b> For contacting conventional 2-gang rocker switches. With middle position. The bus can be connected via enclosed terminal block. To be installed with 8511 rockers.</p>	<b>6108/02-509</b>	2CKA006133A0215	1



### Rockers



Color	Article-No.	Order-No.	Pack/Qty
 <p><b>Rocker for switch, 1-gang</b> Rocker for 6108/01-509 KNX Push-button coupler.</p>			
Soft White	<b>8501 BL</b>	2CLA850100A1101	20
Silver	<b>8501 PL</b>	2CLA850100A1301	20
Soft Black	<b>8501 NS</b>	2CLA850100A1501	20
Stainless Steel	<b>8501 AI</b>	2CLA850100A1401	20
Antique Gold	<b>8501 OE</b>	2CLA850100A1201	20
White Glass	<b>8501 CB</b>	2CLA850100A2101	10
Black Glass	<b>8501 CN</b>	2CLA850100A2501	10

Color	Article-No.	Order-No.	Pack/Qty
 <p><b>Rocker for switch/push-button, 2-gangs</b> Rocker for 6108/02-509 KNX Push-button coupler.</p>			
Soft White	<b>8511 BL</b>	2CLA851100A1101	20
Silver	<b>8511 PL</b>	2CLA851100A1301	20
Soft Black	<b>8511 NS</b>	2CLA851100A1501	20
Stainless Steel	<b>8511 AI</b>	2CLA851100A1401	20
Antique Gold	<b>8511 OE</b>	2CLA851100A1201	20
White Glass	<b>8511 CB</b>	2CLA851100A2101	10
Black Glass	<b>8511 CN</b>	2CLA851100A2501	10

# Sky Niessen - KNX - Building automation

## Sensor

Product	Article-No.	Order-No.	Pack/Qty
	<p><b>KNX Push-button coupler - 2-gang with bus coupler</b>                      With integrated temperature sensor.                      Support of KNX functions through innovative colour concept (yellow=lighting, blue=blind, orange=RTC, magenta=scene and white=neutral/no function assigned) or standard illumination red/green.                      With middle position.                      The bus can be connected via enclosed terminal block.                      Control element: switch contacts top/bottom.                      Display elements: 2 LED per rocker via separate communication object for status (Red/ Green/ OFF) or orientation light.                      Connections: KNX-line - bus connection terminal.                      Rated voltage: 24 V-, +5 V / -5 V.                      Temperature range device: -5 °C to 45 °C.                      To be installed with SR-1-85, SRL-1-85, SRD-1-85, SRB-1-85 and SRS-1-85 cover plates.</p>	2CKA006133A0221	1
	<p><b>KNX Push-button coupler - 4-gang with bus coupler</b>                      With integrated temperature sensor.                      Support of KNX functions through innovative colour concept (yellow=lighting, blue=blind, orange=RTC, magenta=scene and white=neutral/no function assigned) or standard illumination red/green.                      With middle position.                      The bus can be connected via enclosed terminal block.                      Control element: switch contacts top/bottom.                      Display elements: 2 LED per rocker via separate communication object for status (Red/ Green/ OFF) or orientation light.                      Connections: KNX-line - bus connection terminal.                      Rated voltage: 24 V-, +5 V / -5 V.                      Temperature range device: -5 °C to 45 °C.                      To be installed with SR-2-85, SRL-2-L-85 SRL-2-R-85, SRD-2-L-85, SRD-2-R-85, SRB-2-85 SRS-2-L-85 and SRS-2-R-85 cover plates.</p>	2CKA006133A0223	1
	<p><b>KNX Room thermostat with display</b>                      Control element with room thermostat function for triggering the heating, ventilation and fan-coil actuators.                      For controlling commercially available valve drives.                      With display of set-value temperature.                      Master/slave configuration.                      With base-load operation.                      The bus can be connected via enclosed terminal block.                      Class of temperature controller 1                      Contribution to space heating energy efficiency 1,0%.                      Control element: switch contacts.                      Display elements: LCD showing operation mode and temperature.                      Connections: KNX-line - bus connection terminal.                      Rated voltage / current: 24 V- / 5 mA.                      Temperature range device: -5 °C to 45 °C.                      To be installed with CP-RTC-85 cover plates for RTC or CP-RTC-FC-85 cover plates for fan coil control.</p>	2CKA006134A0319	1

Product	Article-No.	Order-No.	Pack/Qty
	<p><b>KNX RTC with 5-gang universal input</b>                      Control element with room thermostat function for triggering the heating, ventilation and fan-coil actuators.                      With universal input with:                      - max. of 5 binary inputs.                      - 4 binary inputs and 1 analogue input for activating sensors with external power supply 1-10 V/0-10 V                      - 2 binary inputs and 1 analogue input for activating sensors with external power supply 1-10 V/0-10 V and an external temperature sensor PT1000 / T6226.                      With display of set-value temperature.                      Master/slave configuration.                      With base-load operation.                      The bus can be connected via enclosed terminal block.                      Class of temperature controller 1.                      Contribution to space heating energy efficiency 1,0%.                      Control element: switch contacts.                      Display elements: LCD showing operation mode and temperature.                      Connections: KNX-line - bus connection terminal.                      Rated voltage / current: 24 V- / 5 mA.                      Inputs: 5. Polling voltage: binary inputs, presence and/or window contact.                      Control/Signal outputs: 1, 0-10 V (passive).                      Temperature range device: -5 °C to 45 °C.                      To be installed with CP-CO-85 cover plates.</p>	2CKA006134A0315	1
	<p><b>KNX RTC with CO2/moisture sensor</b>                      Control element with room temperature controller function and CO2/moisture/air pressure sensor.                      For activating heating, ventilation and fan coil actuators.                      With universal input with:                      - max. of 5 binary inputs.                      - 4 binary inputs and 1 analogue input for activating sensors with external power supply 1-10 V/0-10 V.                      - 2 binary inputs and 1 analogue input for activating sensors with external power supply 1-10 V/0-10 V and an external temperature sensor PT1000 / T6226.                      With display of set-value temperature.                      Master/slave configuration.                      With base-load operation.                      The bus can be connected via enclosed terminal block.                      Class of temperature controller 1.                      Contribution to space heating energy efficiency 1,0%.                      Control element: switch contacts.                      Display elements: LCD showing operation mode and temperature.                      Connections: KNX-line - bus connection terminal.                      Rated voltage / current: 24 V- / 5 mA.                      Inputs: 5. Polling voltage: binary inputs, presence and/or window contact.                      Control/Signal outputs: 1, 0-10 V (passive).                      Temperature range device: -5 °C to 45 °C.</p>	2CKA006134A0317	1
	<p><b>KNX 180° motion sensor</b>                      Movement detector with up to 4 channels.                      Detection range: frontal: 6 m, lateral: 6 m.                      Brightness limit value: 5 lux - 150 lux.                      Detection angle: 180°.                      Position for installation: vertical.                      Mounting height: 1.1 m.                      Temperature range (device): -5 °C to 45 °C.                      To be installed with CP-MD-85 cover plates (mounting grid without claws included).</p>	2CKA006132A0307	1

## Sky Niessen - KNX - Building automation

### Cover plates

Color	Article-No.	Order-No.	Pack/Qty
	Cover plate - KNX 1-gang sensors Cover plate for KNX 1-gang sensors code: 6108/06-500. Without symbol.		
Soft White	<b>SR-1-85 BL</b>	2CLA852620A1101	1
Silver	<b>SR-1-85 PL</b>	2CLA852620A1301	1
Soft Black	<b>SR-1-85 NS</b>	2CLA852620A1501	1
Stainless Steel	<b>SR-1-85 AI</b>	2CLA852620A1401	1
Antique Gold	<b>SR-1-85 OE</b>	2CLA852620A1201	1

	Cover plate - KNX 1-gang sensors - Switch Cover plate for KNX 1-gang sensors code: 6108/06-500. With Light symbol.		
Soft White	<b>SRL-1-85 BL</b>	2CLA852626A1101	1
Silver	<b>SRL-1-85 PL</b>	2CLA852626A1301	1
Soft Black	<b>SRL-1-85 NS</b>	2CLA852626A1501	1
Stainless Steel	<b>SRL-1-85 AI</b>	2CLA852626A1401	1
Antique Gold	<b>SRL-1-85 OE</b>	2CLA852626A1201	1

	Cover plate - KNX 1-gang sensors - Dimmer Cover plate for KNX 1-gang sensors code: 6108/06-500. With Dimming symbol.		
Soft White	<b>SRD-1-85 BL</b>	2CLA852625A1101	1
Silver	<b>SRD-1-85 PL</b>	2CLA852625A1301	1
Soft Black	<b>SRD-1-85 NS</b>	2CLA852625A1501	1
Stainless Steel	<b>SRD-1-85 AI</b>	2CLA852625A1401	1
Antique Gold	<b>SRD-1-85 OE</b>	2CLA852625A1201	1

	Cover plate - KNX 1-gang sensors - Blind Cover plate for KNX 1-gang sensors code: 6108/06-500. With Blind symbol.		
Soft White	<b>SRB-1-85 BL</b>	2CLA852623A1101	1
Silver	<b>SRB-1-85 PL</b>	2CLA852623A1301	1
Soft Black	<b>SRB-1-85 NS</b>	2CLA852623A1501	1
Stainless Steel	<b>SRB-1-85 AI</b>	2CLA852623A1401	1
Antique Gold	<b>SRB-1-85 OE</b>	2CLA852623A1201	1

	Cover plate - KNX 1-gang sensors - Scene Cover plate for KNX 1-gang sensors code: 6108/06-500. With Scene symbol.		
Soft White	<b>SRS-1-85 BL</b>	2CLA852627A1101	1
Silver	<b>SRS-1-85 PL</b>	2CLA852627A1301	1
Soft Black	<b>SRS-1-85 NS</b>	2CLA852627A1501	1
Stainless Steel	<b>SRS-1-85 AI</b>	2CLA852627A1401	1
Antique Gold	<b>SRS-1-85 OE</b>	2CLA852627A1201	1

Color	Article-No.	Order-No.	Pack/Qty
	Cover plate - KNX 2-gang sensors Cover plate for KNX 2-gang sensors code: SU-F-2.0.1, SSA-F-2.1.1, SSA-F-2.2.1, SDA-F-2.1.1, SBA-F-2.1.1, SU-F-2.0.1-WL, SSA-F-2.1.1-WL, SSA-F-2.2.1-WL, SDA-F-2.1.1-WL, SBA-F-2.1.1-WL. Without symbol. Suitable for both gangs.		
Soft White	<b>SR-2-85 BL</b>	2CLA852640A1101	1
Silver	<b>SR-2-85 PL</b>	2CLA852640A1301	1
Soft Black	<b>SR-2-85 NS</b>	2CLA852640A1501	1
Stainless Steel	<b>SR-2-85 AI</b>	2CLA852640A1401	1
Antique Gold	<b>SR-2-85 OE</b>	2CLA852640A1201	1

	Cover plate - KNX 2-gang sensors - Switch - Left Cover plate for KNX 2-gang sensors code: 6108/07-500. With Light symbol. Suitable for the left gang.		
Soft White	<b>SRL-2-L-85 BL</b>	2CLA852642A1101	1
Silver	<b>SRL-2-L-85 PL</b>	2CLA852642A1301	1
Soft Black	<b>SRL-2-L-85 NS</b>	2CLA852642A1501	1
Stainless Steel	<b>SRL-2-L-85 AI</b>	2CLA852642A1401	1
Antique Gold	<b>SRL-2-L-85 OE</b>	2CLA852642A1201	1

	Cover plate - KNX 2-gang sensors - Switch - Right Cover plate for KNX 2-gang sensors code: 6108/07-500. With Light symbol. Suitable for the right gang.		
Soft White	<b>SRL-2-R-85 BL</b>	2CLA852648A1101	1
Silver	<b>SRL-2-R-85 PL</b>	2CLA852648A1301	1
Soft Black	<b>SRL-2-R-85 NS</b>	2CLA852648A1501	1
Stainless Steel	<b>SRL-2-R-85 AI</b>	2CLA852648A1401	1
Antique Gold	<b>SRL-2-R-85 OE</b>	2CLA852648A1201	1

	Cover plate - KNX 2-gang sensors - Dimmer - Left Cover plate for KNX 2-gang sensors code: 6108/07-500. With Dimming symbol. Suitable for the left gang.		
Soft White	<b>SRD-2-L-85 BL</b>	2CLA852641A1101	1
Silver	<b>SRD-2-L-85 PL</b>	2CLA852641A1301	1
Soft Black	<b>SRD-2-L-85 NS</b>	2CLA852641A1501	1
Stainless Steel	<b>SRD-2-L-85 AI</b>	2CLA852641A1401	1
Antique Gold	<b>SRD-2-L-85 OE</b>	2CLA852641A1201	1

## Sky Niessen - KNX - Building automation

### Cover plates

Color	Article-No.	Order-No.	Pack/Qty
	<b>Cover plate - KNX 2-gang sensors - Dimmer - Right</b> Cover plate for KNX 2-gang sensors code: 6108/07-500. With Dimming symbol. Suitable for the right gang.		
Soft White	<b>SRD-2-R-85 BL</b>	2CLA852640A2101	1
Silver	<b>SRD-2-R-85 PL</b>	2CLA852640A2301	1
Soft Black	<b>SRD-2-R-85 NS</b>	2CLA852640A2501	1
Stainless Steel	<b>SRD-2-R-85 AI</b>	2CLA852640A2401	1
Antique Gold	<b>SRD-2-R-85 OE</b>	2CLA852640A2201	1

	<b>Cover plate - KNX 2-gang sensors - Blind</b> Cover plate for KNX 2-gang sensors code: 6108/07-500. With Blind symbol. Suitable for both gangs.		
Soft White	<b>SRB-2-85 BL</b>	2CLA852643A1101	1
Silver	<b>SRB-2-85 PL</b>	2CLA852643A1301	1
Soft Black	<b>SRB-2-85 NS</b>	2CLA852643A1501	1
Stainless Steel	<b>SRB-2-85 AI</b>	2CLA852643A1401	1
Antique Gold	<b>SRB-2-85 OE</b>	2CLA852643A1201	1

	<b>Cover plate - KNX 2-gang sensors - Scene - Left</b> Cover plate for KNX 2-gang sensors code: 6108/07-500. With Scene symbol. Suitable for the left gang.		
Soft White	<b>SRS-2-L-85 BL</b>	2CLA852644A1101	1
Silver	<b>SRS-2-L-85 PL</b>	2CLA852644A1301	1
Soft Black	<b>SRS-2-L-85 NS</b>	2CLA852644A1501	1
Stainless Steel	<b>SRS-2-L-85 AI</b>	2CLA852644A1401	1
Antique Gold	<b>SRS-2-L-85 OE</b>	2CLA852644A1201	1

	<b>Cover plate - KNX 2-gang sensors - Scene - Right</b> Cover plate for KNX 2-gang sensors code: 6108/07-500. With Scene symbol. Suitable for the right gang.		
Soft White	<b>SRS-2-R-85 BL</b>	2CLA852647A1101	1
Silver	<b>SRS-2-R-85 PL</b>	2CLA852647A1301	1
Soft Black	<b>SRS-2-R-85 NS</b>	2CLA852647A1501	1
Stainless Steel	<b>SRS-2-R-85 AI</b>	2CLA852647A1401	1
Antique Gold	<b>SRS-2-R-85 OE</b>	2CLA852647A1201	1

Color	Article-No.	Order-No.	Pack/Qty
	<b>Cover plate - KNX RTC</b> Cover plate with RTC symbols for KNX room temperature controller code: 6108/18-500.		
Soft White	<b>CP-RTC-85 BL</b>	2CLA854060A1101	1
Silver	<b>CP-RTC-85 PL</b>	2CLA854060A1301	1
Soft Black	<b>CP-RTC-85 NS</b>	2CLA854060A1501	1
Stainless Steel	<b>CP-RTC-85 AI</b>	2CLA854060A1401	1
Antique Gold	<b>CP-RTC-85 OE</b>	2CLA854060A1201	1

	<b>Cover plate - KNX fan coil control</b> Cover plate with fan coil control symbols for KNX room temperature controller code: 6108/18-500.		
Soft White	<b>CP-RTC-FC-85 BL</b>	2CLA855420A1101	1
Silver	<b>CP-RTC-FC-85 PL</b>	2CLA855420A1301	1
Soft Black	<b>CP-RTC-FC-85 NS</b>	2CLA855420A1501	1
Stainless Steel	<b>CP-RTC-FC-85 AI</b>	2CLA855420A1401	1
Antique Gold	<b>CP-RTC-FC-85 OE</b>	2CLA855420A1201	1

	<b>Cover plate - KNX RTC with CO2/moisture sensor</b> Cover plate for KNX 5-gang RTC and CO2/moisture RTC sensor code: 6109/18-500 and 6109/28-500.		
Soft White	<b>CP-CO-85 BL</b>	2CLA855430A1101	1
Silver	<b>CP-CO-85 PL</b>	2CLA855430A1301	1
Soft Black	<b>CP-CO-85 NS</b>	2CLA855430A1501	1
Stainless Steel	<b>CP-CO-85 AI</b>	2CLA855430A1401	1
Antique Gold	<b>CP-CO-85 OE</b>	2CLA855430A1201	1

	<b>Cover plate - KNX motion sensor</b> Cover plate for KNX motion sensors code: 6122/98-509.		
Soft White	<b>CP-MD-85 BL</b>	2CLA854160A1101	1
Silver	<b>CP-MD-85 PL</b>	2CLA854160A1301	1
Soft Black	<b>CP-MD-85 NS</b>	2CLA854160A1501	1
Stainless Steel	<b>CP-MD-85 AI</b>	2CLA854160A1401	1
Antique Gold	<b>CP-MD-85 OE</b>	2CLA854160A1201	1



## Diagrams & dimensions

**Thinking of making your job easier.** We create this supporting material to optimize your time. We provide all the technical information, diagrams and dimensions of each of our products in a clear and precise manner to facilitate understanding.

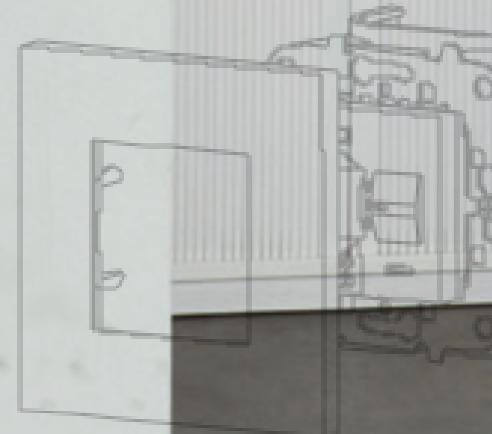
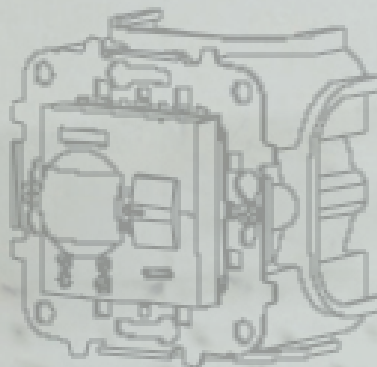
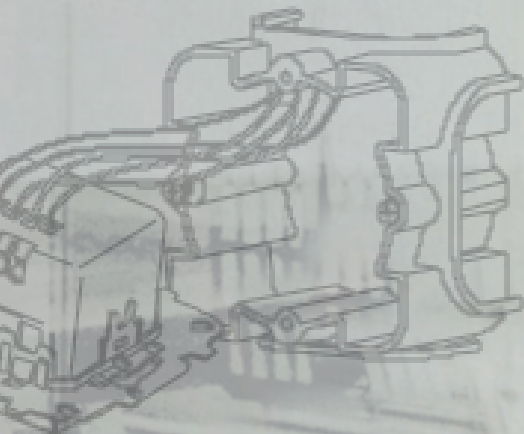
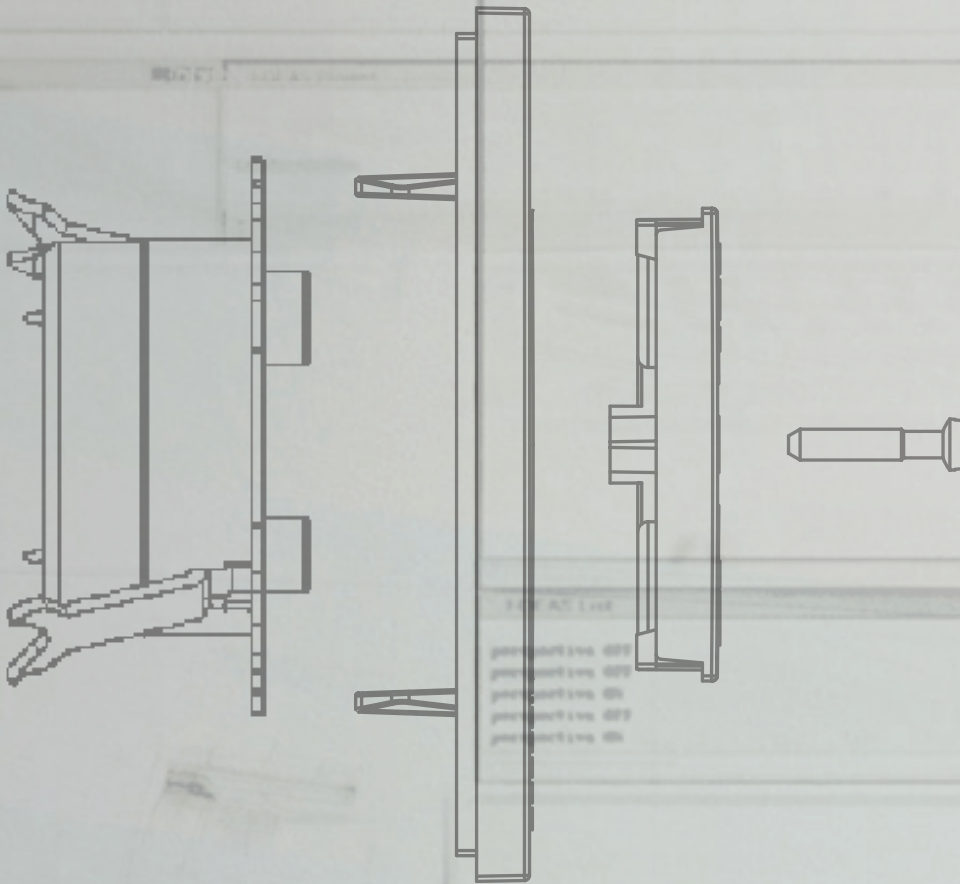



## Luxury insert

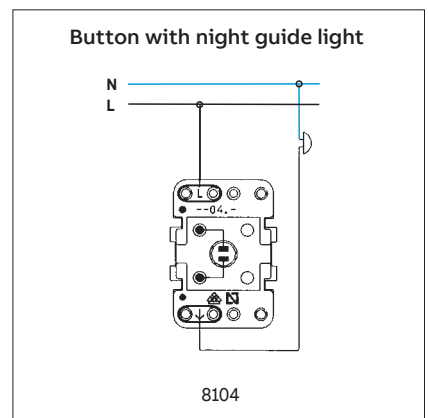
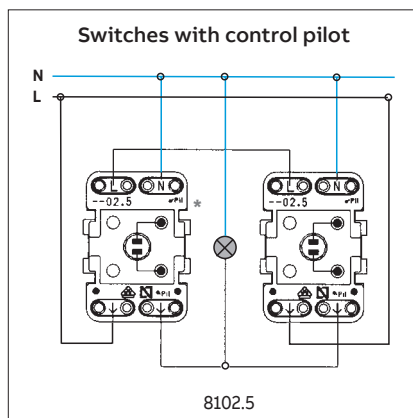
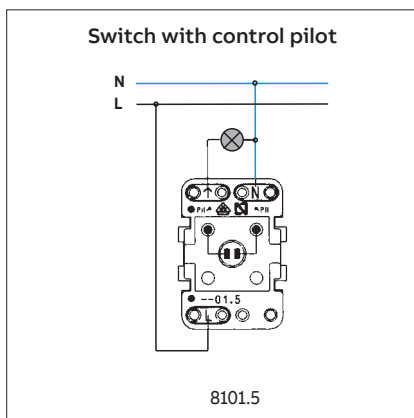
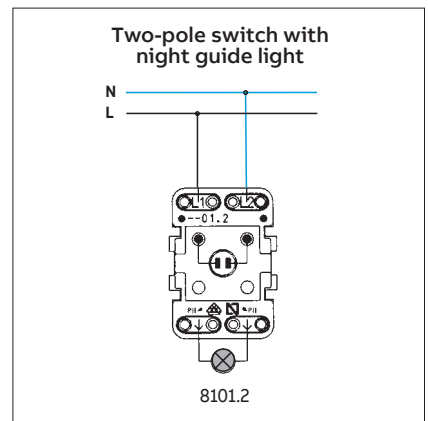
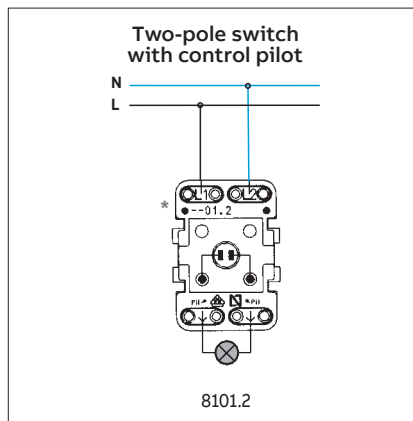
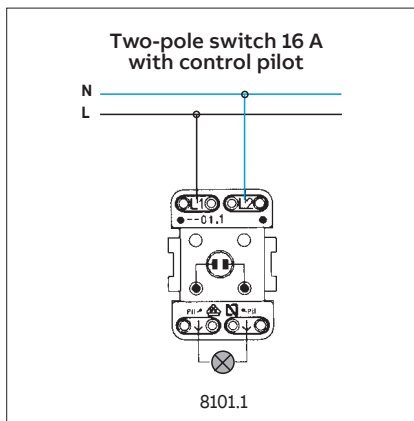
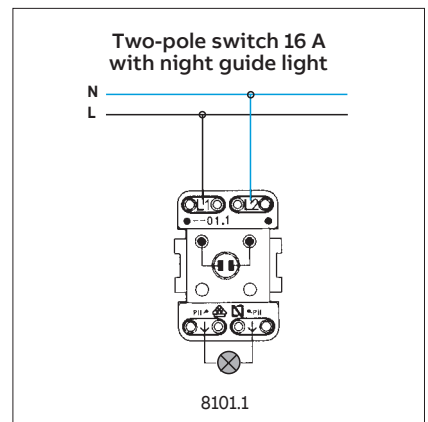
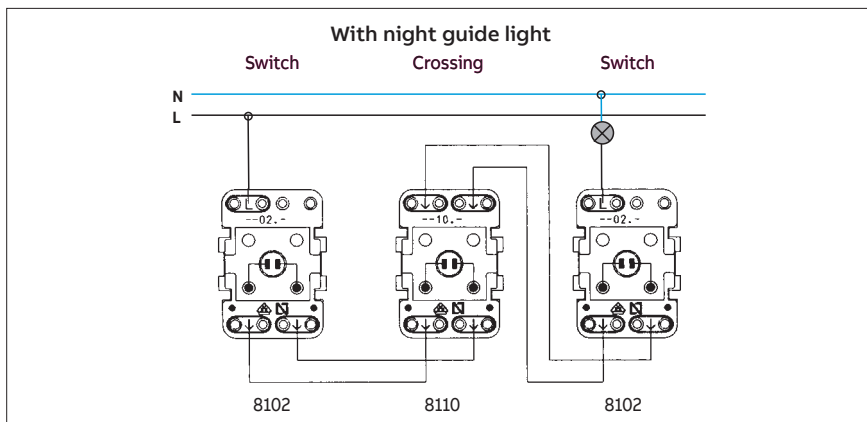
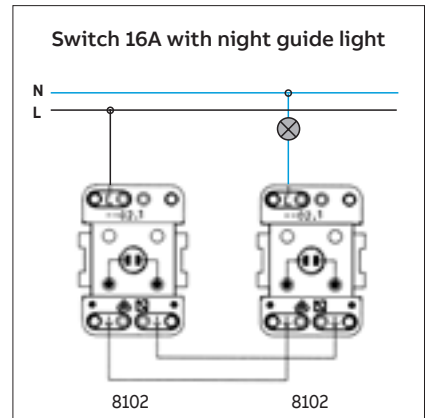
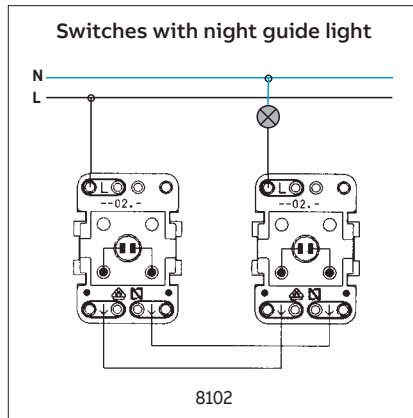
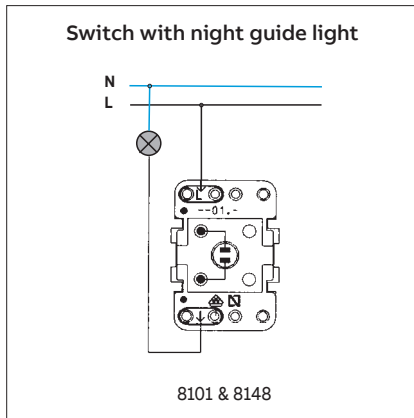

\* The • indicates where the night guide lamp must be connected.  
 \* The "pil" indicates where the control pilot lamp must be connected.



**Luxury insert**

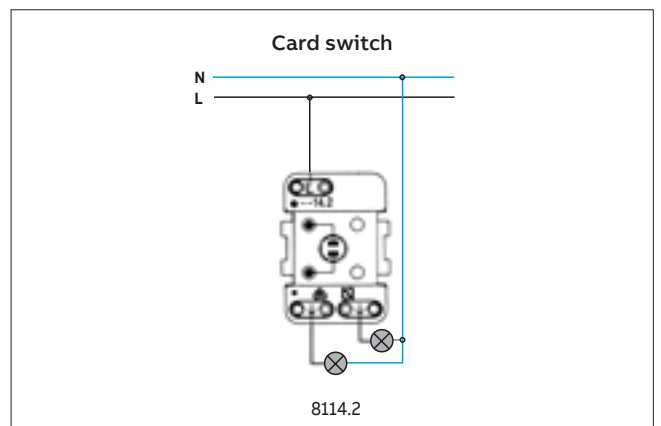
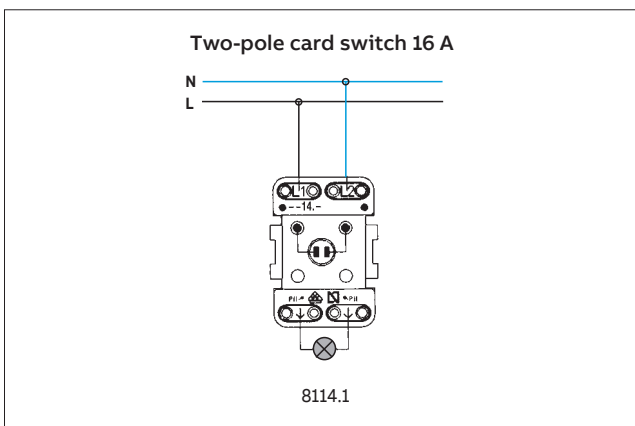
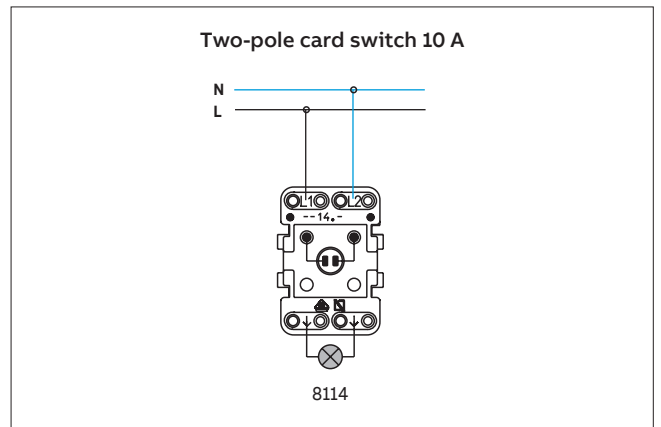
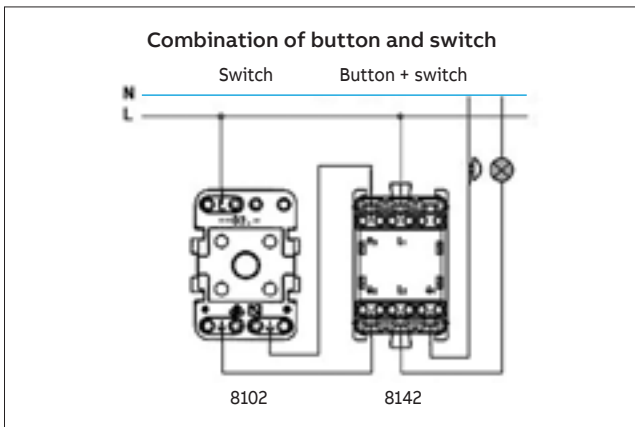
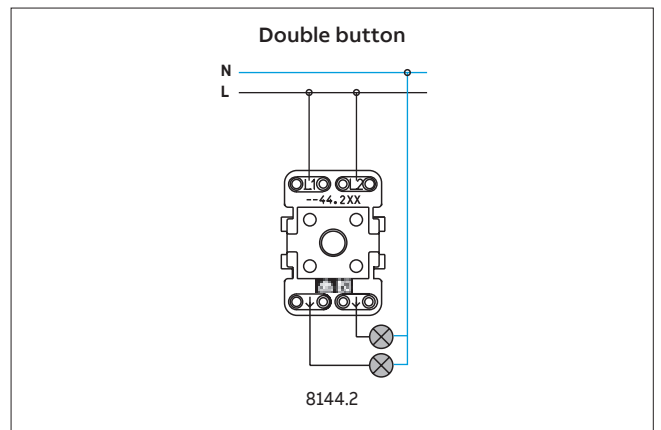
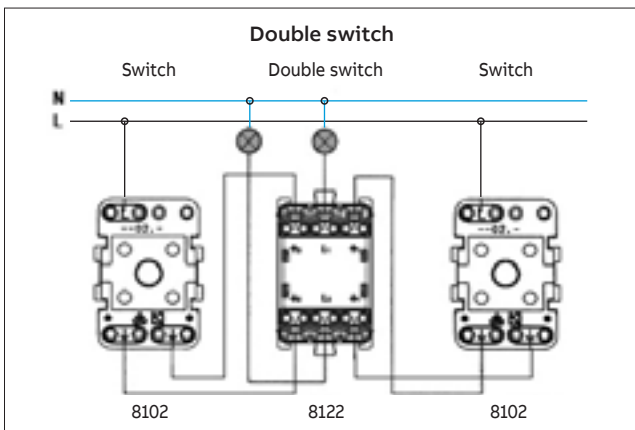
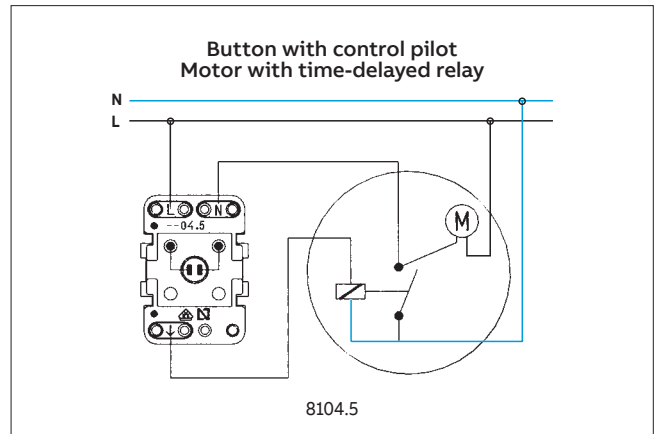
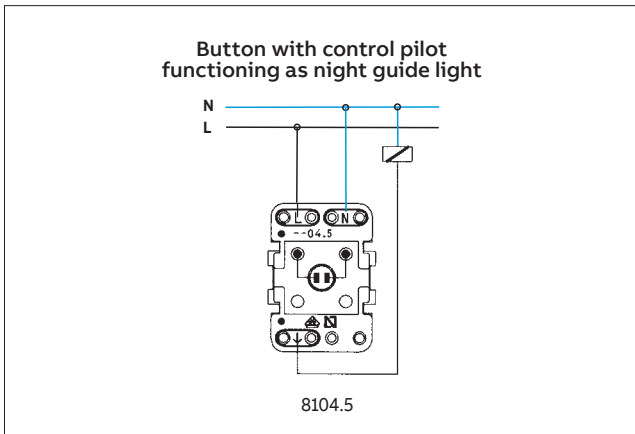



## Luxury insert

### Time-delayed connection card switch. 8114.5

**Technical characteristics:**

- Power supply: 127 V~ / 60 Hz
- 230 V~ / 50 Hz

Valid for the following types of loads:

(a) Conventional incandescent lamps, halogen incandescent lamps at 230 V~ or 127 V~, low voltage halogen lamps with conventional transformer or electronic transformer and motors:

At 230 V~, 50 Hz, maximum power 3,000 W

At 127 V~, 60 Hz, maximum power 1,600 W

(b) Fluorescent lamps:

At 230 V~, 50 Hz, maximum power 1,300 W

At 127 V~, 60 Hz, maximum power 700 W

**Operation**

This appliance detects whether a card is present in the card slot.

(a) Whenever it detects the presence of a card, it connects the load. It will maintain the load connected for the time the card remains present.

(b) When, after having inserted a card, this is removed, the device will delay the cut-out of the load, according to the programmed time.

**Assembly**

- 1.- Secure the mechanism (1) in the recessed box with the screws of the box.
- 2.- Fit the frame (2) onto the mechanism.
- 3.- Secure the support (3) with the screws to the mechanism.
- 4.- Position the cover (4) onto the support.

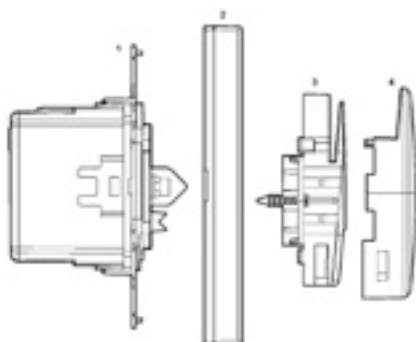

**Connection diagram:**

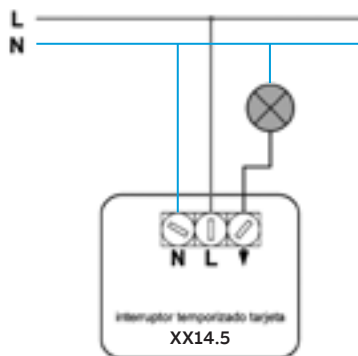

**Programming the load disconnection times when the card is removed.**

It is possible to select the disconnection times after the card is removed, through the rotating potentiometer for programming on the cover.

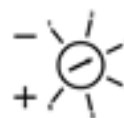

Step	Waiting time for disconnection
1.-	5 s.
2.-	10 s.
3.-	20 s.
4.-	30 s.
5.-	60 s.
6.-	90 s.

### Switch-switch (code: 8153) / Push-button (8153.2) Two-position key

Diagram as switch/button  
8153 / 8153.2

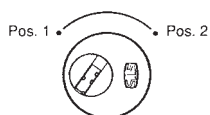
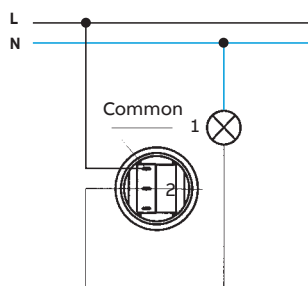

Position of the key	Active contacts
1	Common and 1
2	Common and 2

Diagram as switch

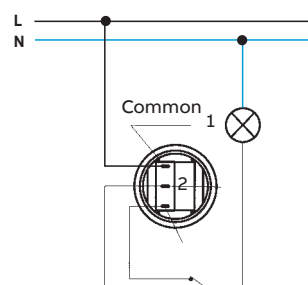

## Luxury insert

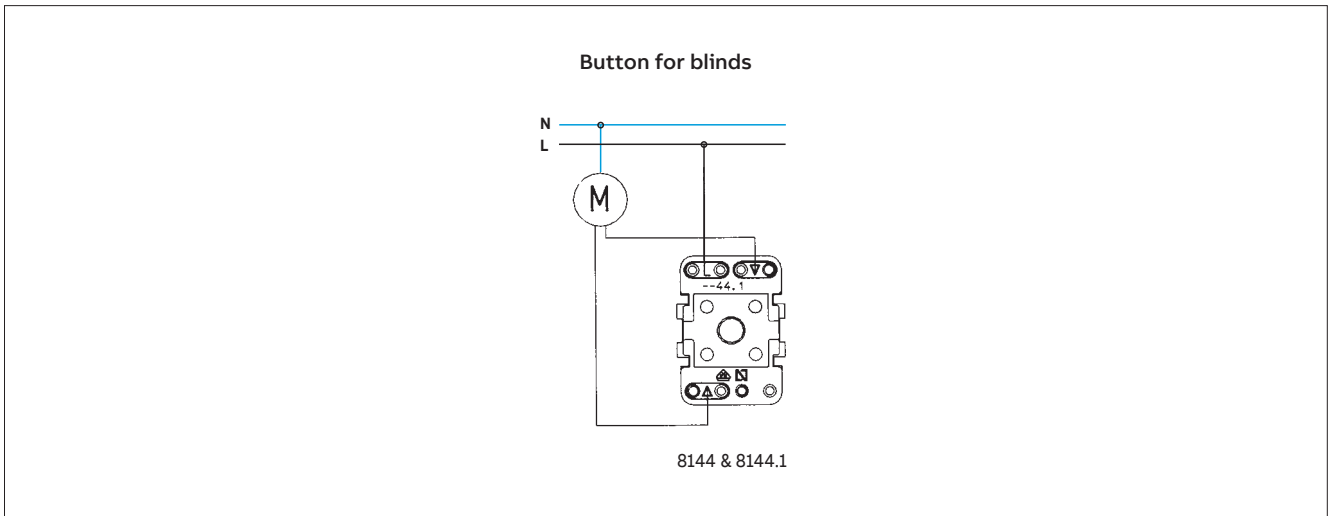

## Switch for blinds

8130.3

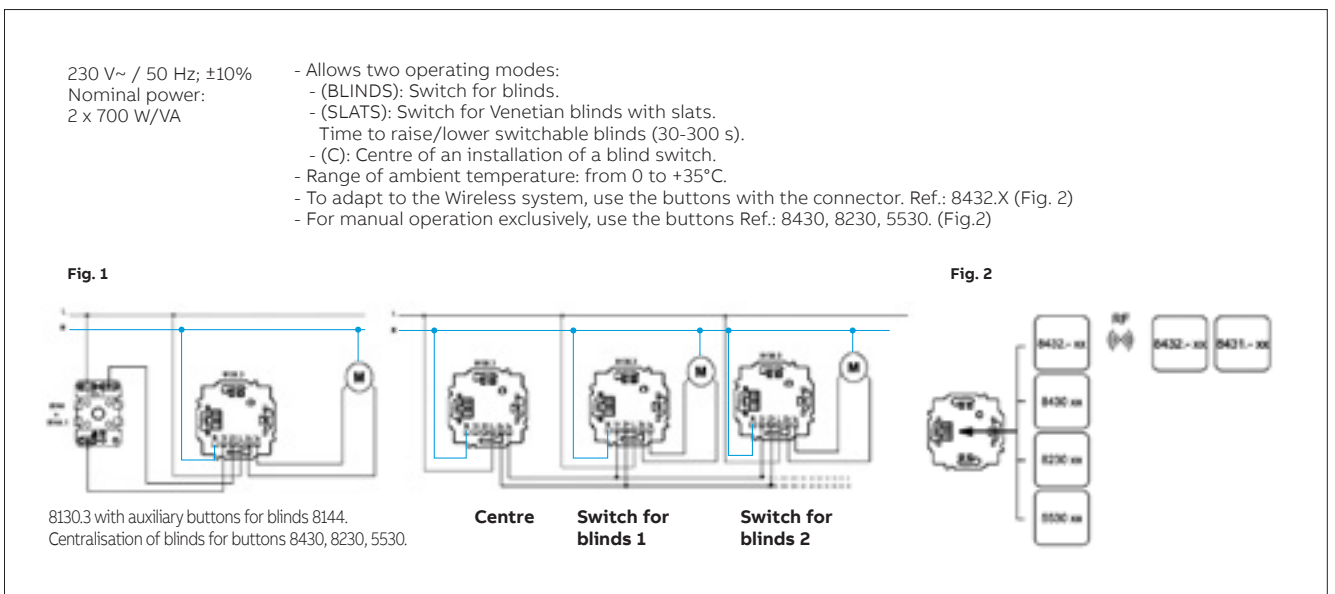

## USB charger

8185

**1.- Technical data:**

**Nom. input voltage:** 100 - 240 V AC  $\pm$  10 %

**Nom. input frequency:** 50 - 60 Hz

**Nom. input current:**  
8185 and N2285: 0,20Aca at max load  
N2185: 0,12Aca at max load

**Stand-by current:** 230 V AC :  $\leq$  0,3 W

**Nom. output voltage:** 5 V DC +5 / -5 %

**Output current:**  
8185 and N2285: 1500 mA at 5 V DC  
N2185: 750 mA at 5 V DC

**Operating temp.:**  
8185 and N2285: 0° C + 35° C  
N2185: 0° C + 45° C

**Energy efficiency:**  
8185 and N2285:  $\geq$  71%  
N2185:  $\geq$  66%

**2.- Electric safety data**

**Safety standard:** EN60950-I

**Safety standard:** II - Low voltage

**Separation (prim. sec.):**  
Converter with galvanic insulation

**3.- Mean charge times for devices with lithium ion polymer compound batteries (for 8185 or N2285):**

- 80% of the charge <1 h 15
- 100% of the charge <2 h 05

**4.- Example of application:** 8185

**5.- Connection diagrams**

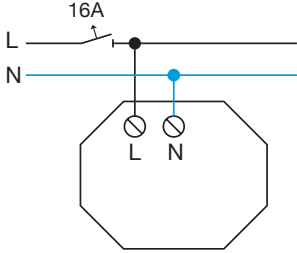

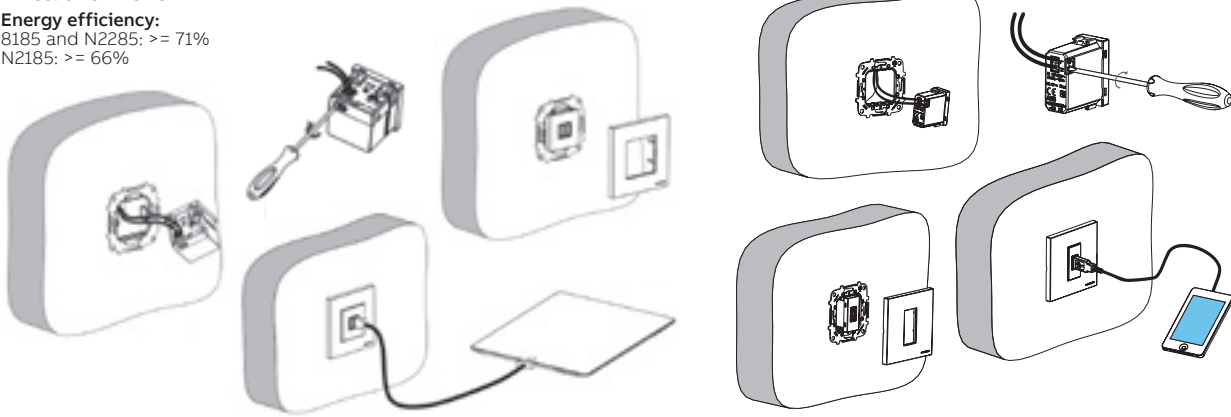

## USB charger 2A

8185.2 &amp; 8185.3

**1.- Technical data:**

**Nom. input voltage:** 100 - 230 V AC  $\pm$  10 %

**Nom. input frequency:** 50 - 60 Hz

**Nom. input current:** <0,2A AC at max load

**Stand-by current:** <10 MW at 230 V AC, no load

**Nom. output voltage:** 5 V DC +5 / -5 %

**Output current per outlet:** 2000mA at 5V DC

**Operating temp.:**  
0°C to 45°C, installing one USB charger N2185.2 or 8185.2.  
0°C to 30°C, installing one charger 8185.3 or two N2185.2 together.

**Energy efficiency:**  $\geq$  79%

**3.- Installation:**

**3.2.- Installation of USB charger with one outlet 8185.2**

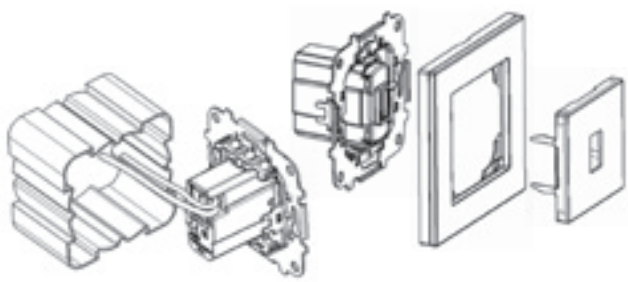

Fig. 1. Diagram 8185.2

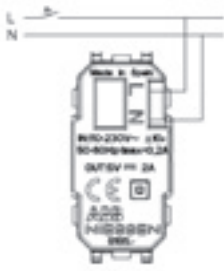
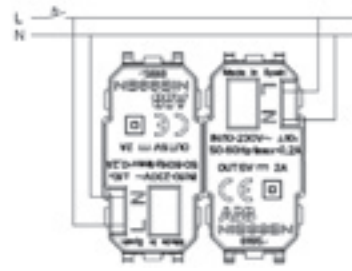
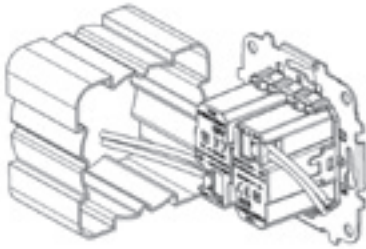

Fig. 2. Diagram 8185.3



**3.3.- Fig. 5. -Installation of USB charger with two outlets 8185.3**



# TV / R outlets

## Technical data

- Connection: Screw terminal and clamp. Coaxial cable 75 ohm.
- Shielded zamak and metal plate chassis.
- In conformity with EN 50083-1:1993, EN 50083-2:2001, EN 61000-6-1:2001, EN 61000-4-2:1995 ESD 15KV AD, 8KV CD, EN50083-4:1998
- Fits in a Ø60 mm box.

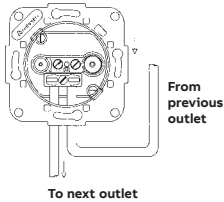

**Important:** the connection of the TV outlets in serial distribution must be carried out according to the figure on the left. The cable coming from the previous outlet is connected in the right terminal and the cable going to the next outlet in the left terminal.

Code		8150	8150.3	8150.7	8150.8	
Installation		Final		Intermediate		
Connection		Screw terminal and clamp				
Output connectors	C1	IEC male Ø 9.52 mm				
	C2	IEC female Ø 9.52 mm				
Frequency range	MHz	I/O				
		C1	5 - 862	5-68/118-862	13 - 862	5 - 862
		C2	5 - 862	87.5 - 108	13 - 862	5 - 862
Basic loss	dB ±TOL	FM	10,0 ±0,7	1,1 ±0,3	25,0 ±1,5	30,0 ±0,2
		DAB	10,0 ±1,5	R: 0,3 ±0,1	25,0 ±1,5	30,0 ±0,2
		VHF	4,0 ±1,5	TV: 0,9 ±0,3	8,0 ±0,7	11,0 ±1,0
		UHF	3,0 ±0,5	-	8,0 ±0,7	10,5 ±1,0
Through loss	dB ±TOL	FM	-	2,0 ±0,3	1,0 ±0,2	
		VHF	-	2,0 ±0,5	1,1 ±0,3	
		UHF	-	2,0 ±0,5	1,3 ±0,4	
Directivity	dB	FM	-	>12	>25	
		TV	-	>9	>13	
Isolation	dB	FM	>14	>18	>16	>20
		TV	>14	>16	>15	>18
Return loss	dB	FM	>18	>16	>12	>18
		TV	>10	>18	>12	>15

**Note:** reference 8150.3 compatible with CATV

## MATV connection diagram Distribution with tap-off units

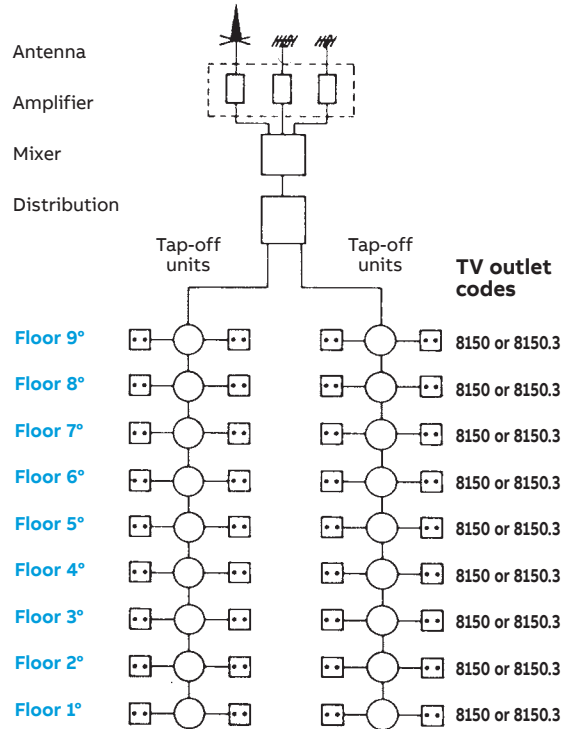

In this diagram all final outlets are the same. References 8150 or 8150.3 can be used equally.

## MATV connection diagram Serial distribution up to 9 floors

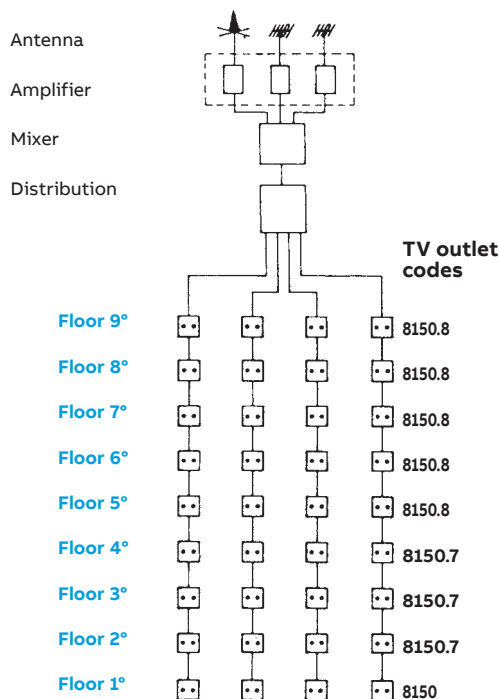

## MATV connection diagram Serial distribution for more than 9 floors

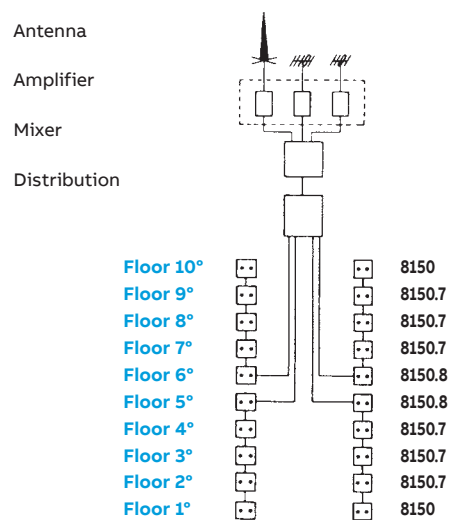

**Example:** 10 floors. The floors are divided in 2 groups of 5 floors each. The outlets are distributed according to the criteria shown in the MATV connection diagram for serial distribution up to 9 floors. The diagram above can be used in buildings up to 18 floors. For buildings with more than 18 floors and up to 27 floors, 3 groups have to be created and so on.



# TV-R / SAT outlets

## SMATV connection diagram

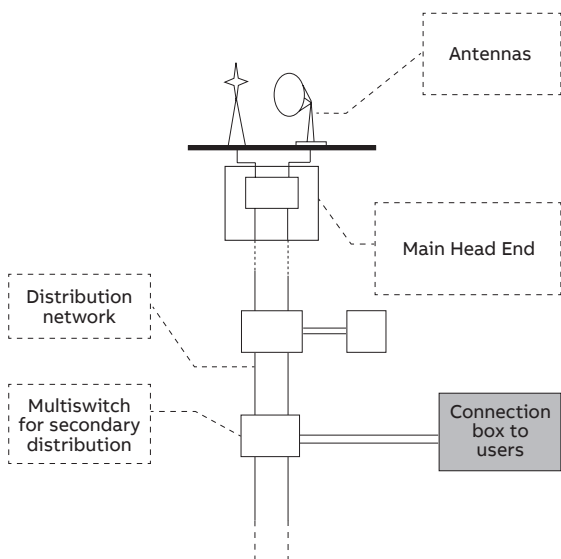

a) SMATV star connection diagram

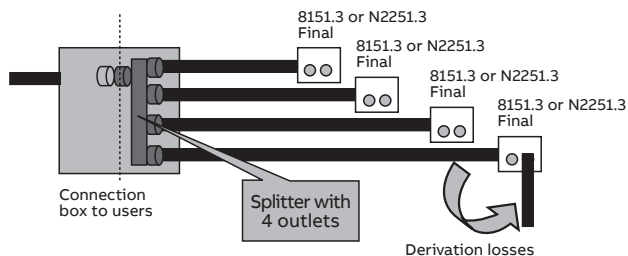

a) SMATV star connection diagram

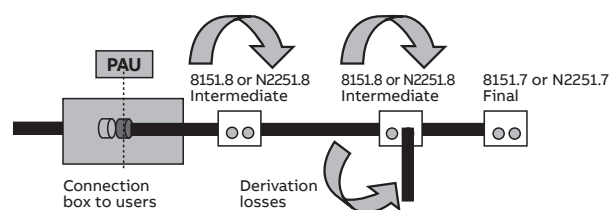

**Note:**

End of line impedance. If the distribution equipment requires outlets with end of line resistors, 8151.7/N2251.7 outlets must be used or add to 8151.3/N2251.3 outlets a termination resistor to close the line.

**Note:**

It is recommended to avoid installing more than 2 intermediate outlets per line.

Code			8151.3 N2251.3	8151.7 N2251.7	8151.8 N2251.8	8152.7
Installation			Final		Intermediate	Final
Connection			Screw terminal and clamp			
Output connectors		C1	IEC male Ø 9.52 mm			
		C2	IEC female Ø 9.52 mm			
		C3	-			F female
Frequency range	MHz	E/S	5 - 2400	5 - 2400		5 - 2500
		C1	5 - 862	5 - 2400		5 - 68 / 125 - 862
		C2	930 - 2400	5 - 2400		87,5 - 108
		C3		-		950 - 2500
Basic loss	dB ±TOL	FM	0,2 ±0,1	3,7 ±0,3	10,0 ±1,0	2,0
		TV	1,0 ±0,5	4,0 ±0,5	10,0 ±1,0	2,7
		SAT	1,2 ±0,6	5,0 ±1,2	12,0 ±2,0	2,3
Through loss	dB ±0,5	FM	-	-	2,5 ±0,5	-
		TV	-	-	2,5 ±0,7	-
		SAT	-	-	3,0 ±1,0	-
Directivity	dB	FM	-	-	>20,0	-
		TV	-	-	>12,0	-
		SAT	-	-	>5,0	-
Isolation	dB	FM	>45	>20	>45	>24,3
		TV	>14	>20	>30	>15
		SAT	>14	>14	>28	>15
Selectivity	dB	FM	-	-	-	>15
		TV-R	>15	-	-	>15
		SAT	>15	-	-	>15
Return loss	dB	VR	>25	>16	>13	>7,6
		FM	>25	>16	>13	>10
		TV	>14	>16	>12	>7,6
		SAT	>10	>9	>12	>8,2
DC path	V <sub>max</sub>		24 max			24 max
	mA		500 max			500 max
	Tono		22 KHz/DiSEqC			22 KHz/DiSEqC

## Telephone outlets

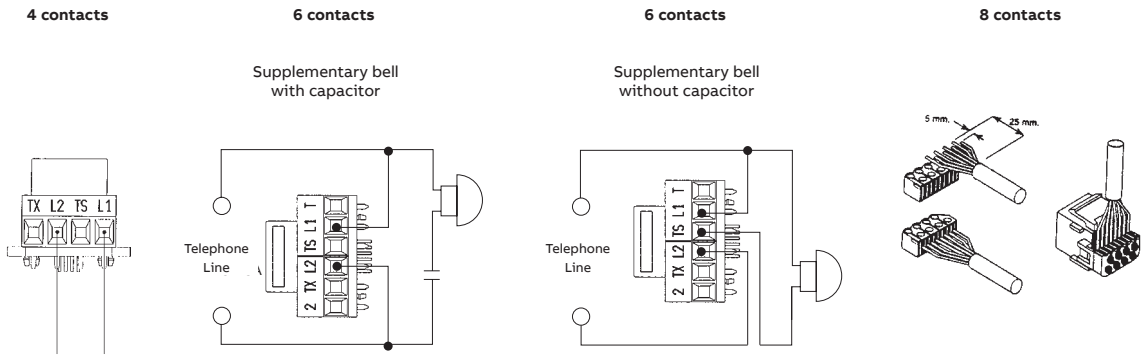

**Connections for special services:**

Special services are understood to be those which need the installation of a subscriber other than the normal one, either in terms of number of wires or connections in the telephone outlet, or in both cases at the same time.

**These services may be:**

Reversed Call (between a main telephone and another extension), Shared Line (two subscribers per terminal), Blocked Dialling by Fee Indicator, Supplementary bell (with and without capacitor), Call transfers, Connection for Fax., Connection for Modem, etc.

**Connections:**

The connection of each of the appliances to the telephone outlet (either to the PRC or private outlet) must be specified by the manufacturer of the appliance in question. However, Electro-mechanical supplementary bell are connected according to the following diagrams.

The references Niessen 8117.3, 2117.8 XX, 2117.8 XX, 2217.8 XX, 2217.8 XX, 2017.3 (terminal access bases, TAB) are supplied with an 8-contact connector that complies with the Standard ISO 8877, without terminating resistor.

Primary ISDN access: Used as elements, cable (in point-to-point configuration), the network termination equipment at primary speed (TR1p, component supplied and owned by the ISDN service provider). If using shielded cables, the connection to the termination equipment shall be fixed with a terminal block with connection to the shield of each pair. Both shield connections can be joined. Optionally an 8-contact connector can be used.

## Female RJ45 Connector Device

2018.6 & AM33322-AN

### 1.- Preparing the Cable

**1.1.-** Put the cable into the hole of cap.



**1.2.-** Cut approximately 5 cm. off the jacket



**1.3.-** Open approx. 10 cm of the jacket with a cutter cord or another tool.



**1.4.-** Cut the jacket



**1.5.-** Cut the mesh (if it has one) and the cord at the same level of the jacket.



### 2.- Preparing the Conductors

**2.1.-** Select the adequate wiring scheme (568A or 568B) and place the pairs in a straight line.

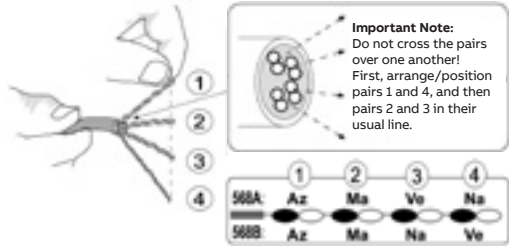

**Important Note:**  
Do not cross the pairs over one another!  
First, arrange/position pairs 1 and 4, and then pairs 2 and 3 in their usual line.

**2.2.-** Position each of the four pairs in the holes of the end piece.



**2.3.-** Set the cover to the module.



**2.4.-** Cut the excess wires.



### 3.- Technical specifications

- Wiring sticker: T568A & T568B
- Winsertion force: 20N max. (IEC 60603-7-4)
- Retention strength: 7.7kg.
- Operating temperature: -10C° — 60C°
- In compliance with ANA/TIA/EIS 568 B-2 standard

## RJ45 Cat. 5E female connector

2018.5

**1.-** Remove the back cap from the connector. Strip approx. 5cm off the jacket and discard the cable cutter cord.

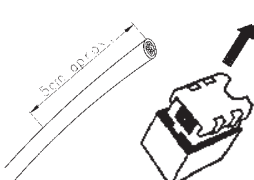

**2.-** Remove the back cap from the connector. Strip approx. 5cm off the jacket and discard the cable cutter cord.

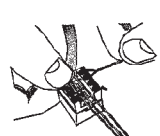

**2a.-** Wiring according to T568A:

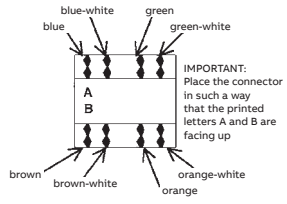

**IMPORTANT:** Place the connector in such a way that the printed letters A and B are facing up

**2b.-** Wiring according to T568B:

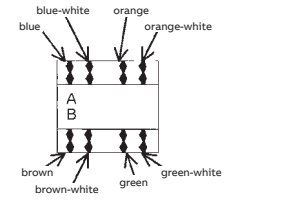

**3.-** Push the cables against the end of the slot and cut them flush to the connector. Use an IBDN 110, BIX, KRONE wiring tool, or a similar type 110 tool.

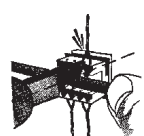

**4.-** Mount the connector cap.



# VDI connectors

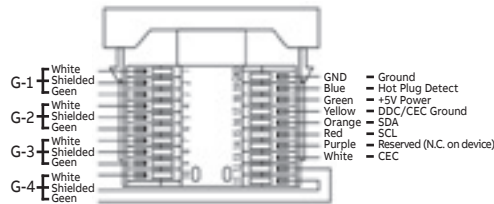
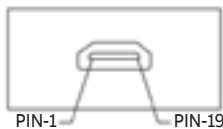
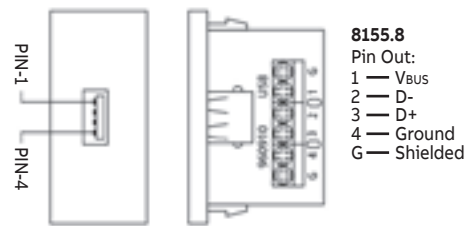
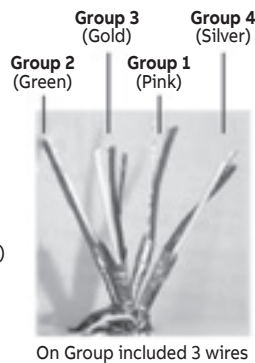
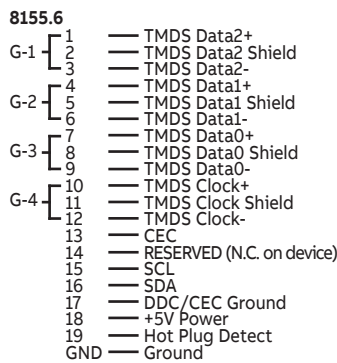
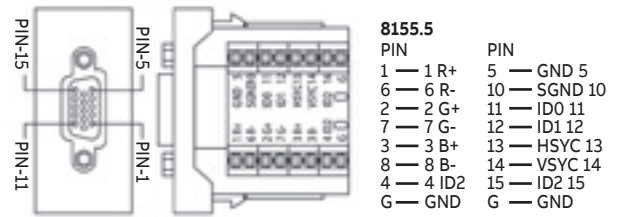
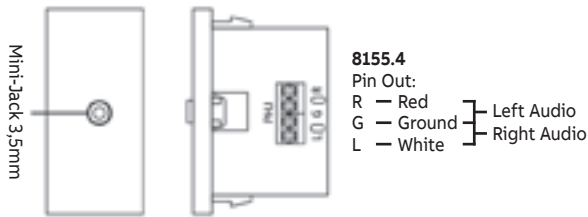
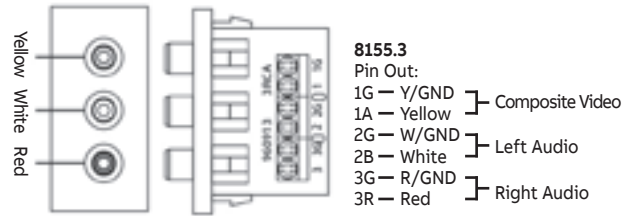
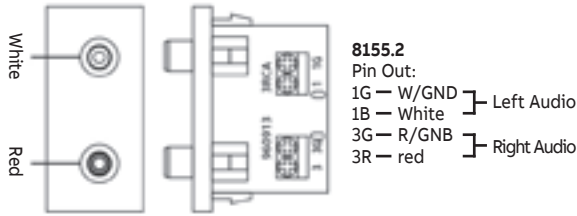

**Note:**  
Using a strap for fixing the cable to the board it is recommended to avoid disconnections. For this the plates have two through-holes at its rear end.



# Rotatory dimmer

Reference	Types of lamps					Power	Switchable
	incandescent	halogen transformer-electromechanical	halogen transformer-electronic	fluorescent lamp	LED		
2260.2	☺	☹	☹	☹	☹	60-400 W	☹
8160*	☺	☺	☹	☹	☹	20-500 W / VA	☺
8160.2	☺	☺	☺	☹	☺	2-100 W / VA LEDi 10-250 W / VA	☺
8160.3	☺	☺	☹	☹	☹	200-1000 W / VA	☺
8160.5	☺	☺	☹	☹	☹	60-400 W / VA	☺
8160.7	☺	☹	☺	☹	☹	40-420 W / VA	☺
8160.9	☹	☹	☹	☺	☹	700 W / VA	☹
8160.8	☺	☺	☺	☹	☹	60-420 W / VA	☺ Regulated with ref. 8161.8
8161.8	Auxiliary component, does not bear load. Up to 5 units connected.						☺

\* Valid for small motors of 300 VA

## Rotatory dimmer, RL, 20-500 W

8160

230 V~ / 50 Hz.  
 ☺ 20-500W  
 ☺ 20-500VA  
 Motors up to 300 VA

- Mechanism valid for cover and button Ref: 5560, 8260.2, 8460.2 and 8560.2
- Protection against short circuit: T3, 15H
- Protection against overload: electronic
- Range of ambient temperature: from 0 to +35°C
- Triac regulator

**Fig. 1**

**Fig. 2**

\* If you wish to fit a night guide light use the 8102.5

**Note:**  
 The nominal power depends on the ambient temperature. In addition, when calculating the nominal power note the transformer losses (20%).

## Rotatory dimmer, LED, 2-100 W

8160.2

**Fig. 1**



**Fig. 2**

Lamp Type	Dimmer Settings			Min. Light
	①	②	③	
LEDi 230 V~	2 W / VA, 100 W / VA	A	20	☺ min
LEDi	2 W / VA, 100 W / VA	A	20	
LEDi	10 W / VA, 250 W / VA	A	-	☺ min
LEDi 230 V~	2 W / VA, 100 W / VA	B	-	
LEDi	2 W / VA, 100 W / VA	B	-	
LEDi	10 W / VA, 250 W / VA	B	-	
230 V~	10 W, 250 W	B	-	
230 V~	10 W, 250 W	B	-	

**Note:**  
 The nominal power depends on the ambient temperature. In addition, when calculating the nominal power note the transformer losses (20%).

## Rotatory dimmer, RL, 200-700 W

(Incan. + halog. electromagnetic transformer). 8160.3

230 V~ / 50 Hz.  
 200-1000W  
 200-1000VA

- Mechanism valid for cover and button Ref: 5560, 8260.2, 8460.2 and 8560.2
- Calibrated fuse T-6.3H Time-delayed
- Protection against short circuit: T 6.3 H
- Range of ambient temperature: 0 - +35°C

**Fig. 1**



**Fig. 2**

**Note:**  
 The nominal power depends on the ambient temperature. In addition, when calculating the nominal power note the transformer losses (20%).

\* If you wish to fit a night guide light use the 8102.5

## Rotatory dimmer, RL, 60-400 W

8160.5

230 V~ / 50 Hz.  
 60-400 W  
 60-400 VA

- 6A complementary circuit switch.
- Mechanism valid for cover and button of ref. 5560, 8260.2, 8460.2 and 8560.2
- Nominal current - switch: 6 A
- Stray current protection: EN 55014
- Minimum load: 60 VA
- Protection against short circuit: T3, 15H
- Maximum protection against short circuit: 10 A
- Range of ambient temperature: from 0 to +35°C



**Fig. 1**

**Fig. 2**

**Note:**  
 The nominal power depends on the ambient temperature. In addition, when calculating the nominal power note the transformer losses (20%).

## Rotatory dimmer, RC, 40-420 W

8160.7

230 V~ / 50 Hz.  
 40-420 W  
 40-420 VA

- Mechanism valid for cover and button of ref. 5560, 8260.2, 8460.2 and 8560.2
- Types of loads: incandescent and/or halogen lamps at 230V and/or halogen with electronic transformer.
- Protection against short circuit: electronic
- Protection against overload: electronic
- Range of ambient temperature: 0 - +35°C

**Fig. 1**

**Fig. 2**

**Note:**  
 The nominal power depends on the ambient temperature. In addition, when calculating the nominal power note the transformer losses.

\* If you wish to fit a night guide light use the 8102.5

## Rotatory dimmer, RLC, 60-420 W & Rotatory dimmer remote control

8160.8 & 8161.8

230 V~ / 50 Hz

☼ 60-420 W

☼ 60-420 VA

☼ 60-420 VA

- Mechanism valid for cover and button Ref: 5560, 8260.2, 8460.2 and 8560.2

- The principal mechanism (8160.8) may be connected to up to 5 auxiliary elements (8161.8) which also regulate the load.

- Range of ambient temperature: 0 to +35°C

- Maximum number of auxiliary elements with an 8160.8: 5 units

- Maximum length of cable 100 m.

- Range of ambient temperature: 0 to +35°C

- Mechanism valid for cover and button Ref: 5560, 8260.2, 8460.2

\* The connection N is only necessary if a night guide light is used in the regulator.

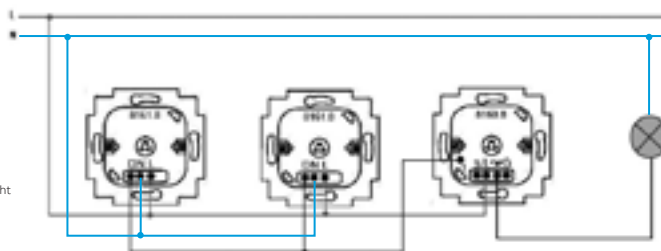

**Note:**

The nominal power depends on the ambient temperature.

In addition, when calculating the nominal power note the losses of the conventional (20%) and electronic (5%) transformers.

## Rotatory dimmer, 1-10Vdc

8160.9

230 V~ / 50 Hz.

☼ 700 VA

- Mechanism valid for cover and button of ref. 5560, 8260.2, 8460.2 and 8560.2

- Valid for fluorescent lights with dimmable electronic ballast.

- Power: 700 VA

- Control voltage: 0/1 - 10 V DC

- Ballast control max. current: 50 mA DC.

- The night guide light must not be installed with this regulator.

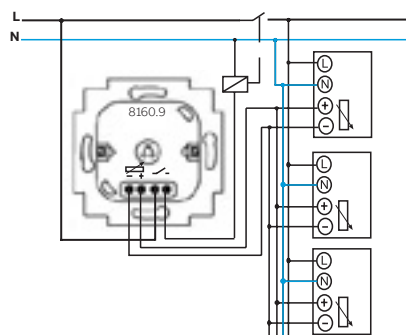
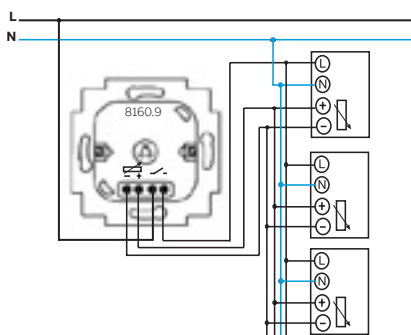

## Rotatory dimmer remote control

8130

230 V~ / 50 Hz; ±10%  
 ⚡ 60-450 W  
 ⚡ 60-450 VA  
 ⚡ 60-450 VA

- Two-wire connection.
- Enables two operating modes selected with the front potentiometer: Regulator and Switch Modes.
- Range of ambient temperature: from 0 to +35°C.
- For manual operation exclusively, use the buttons Ref.: 8530, 8430, 8230 and 5530. (Fig. 2).

**Fig. 1**

**Fig. 2**

\* If you wish to fit a night guide light, use the 8104.5

Note:  
 The nominal power depends on the ambient temperature. In addition, when calculating the nominal power note the losses of the conventional (20%) and electronic (5%) transformer.

## Universal push dimmer 40-450W

8160.1

Mains voltage: 127 V~ / 60 Hz  
 220 V~ / 50 Hz  
 Power: - at 220 V~ / 50 Hz: ⚡ 40 - 450 W  
 ⚡ 40 - 400 VA

Its special characteristics enable convenient remote control using conventional buttons, deriving one conductor only, and thus simplifying the electrical installations as the traditional switched installations can be replaced.

**Short press:**  
 If the regulator was switched off, with a short press the maximum lighting is always connected.  
 If the regulator is switched on, with a short press it is disconnected.  
 A short press is understood to be between 50 ms and 400 ms.

**Long press:**  
 If the regulator was switched off, with a long press, it is connected from minimum lighting and continues the regulation until the button is released.  
 If the regulator was switched off, with a long press, the regulation process starts from the point it was at and until the button is released.  
 A long press is understood to be greater than 400 ms.

Protection against overcurrents: With calibrated fuse Code T-2A. It is supplied with a spare.  
 Protection against erroneous connections: With electronic device. From min. to max. 3.8 seconds.  
 Night guide display: With red LED.  
 Operating temperature: 0° to 30°C.  
 Suppression of interference according to Standards: UNE-20507 and UNE-21806, EN 55014 and EN 60555.

\* If you want a night guide light, use the 8104.5

## Rotatory DALI dimmer & Rotatory DALI dimmer with power supply

8161.4 & 8161.5

8161.5	
Nominal voltage (through the DALI external power supply)	9,5 – 22,5 V =
Power consumption (depending on the colour of the guide light)	7 – 15 mA
Connection for electronic	protection
Maximum number of DALI service units that can be connected (depending on the external power supply)	64
Service temperature	0 °C – +35 °C
Protection class	IP20
Maximum cable length in the system	300 m
Number of colours of the guide light	18 + disconnected

8161.4	
Nominal voltage	230 V~ ±10 %; 50/60 Hz
Power consumption	7 – 15 mA
Gap voltage. Output voltage	15,5 V =
Maximum usable current	75 mA
Connection for electronic	protection
Maximum number of DALI service units that can be connected	37
Service temperature	0 °C – +35 °C
Protection class	IP20
Maximum cable length in the system	300 m
Number of colours of the guide light	18 + disconnected



## Rotatory DALI dimmer & Rotatory DALI dimmer with power supply

8161.4 & 8161.5

### Operation

#### 1- Attenuation speed:



Fig. 1:

Slow rotation of the control element:  
– Precision setting with up to 254 levels of luminosity.

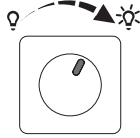

Fig. 2:

Quick rotation of the control element:  
– Large changes in luminosity to reach the desired setting rapidly.

#### 2- Adjusting the basic luminosity:

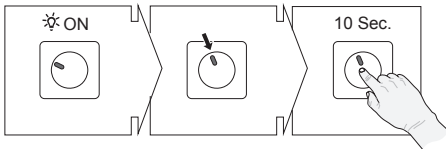

Fig. 3:

To set the basic luminosity, turn the control element slowly.

1. Switch on the lighting.
2. Adjust the lighting.
3. Press the control element for 10 seconds.  
– Once the configuration has been carried out, the load will blink once.

#### 3- Deleting the basic luminosity:

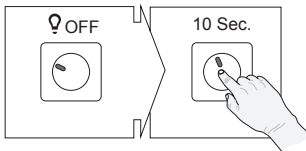

Fig. 4:

To delete the basic luminosity, turn the control element slowly.

1. Turn off the lighting.  
Press the control element for 10 seconds.  
– Once the configuration has been carried out, the load will blink once.

#### 4- Switching on with the memory function:

The DALI potentiometers always switch on the lighting with the last value of luminosity set (memory function). This function overwrites the manual setting of the luminosity connection.

#### 5- Modifying the connection luminosity:

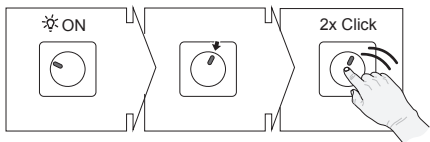

Fig. 5:

To adjust an established luminosity connection the following points must be executed:

1. Switch on the lighting.
2. Adjust the lighting.
3. Double click quickly on the control element.  
– Once the configuration has been carried out, the load will blink twice.  
The memory function overwrites the luminosity connection established (connection with the last luminosity value it had before the disconnection).



#### Note:

If the lighting is disconnected after pressing twice is because the interval between the first and second time the button was pressed too long.

#### 6- Deleting the connection luminosity:

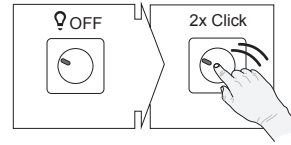

Fig. 6:

To delete an established luminosity connection the following points must be executed:

1. Switch on the lighting.
2. Double click quickly on the control element.  
– Once the configuration has been carried out, the load will blink twice.  
The memory function works again after deleting the luminosity connection established (connection with the last luminosity value it had before the disconnection).

#### 7- Adjusting the colour of the guide light:



Fig. 7:

To change the colour of the connection light, do the following:

1. Turn off the lighting (load).
2. Press the control element, hold it down and rotate it quickly three times from one side to the other.
3. Release the control element.  
– The guide light blinks 3 times.
4. Turn the control element to choose the colour of the LED.
5. Confirm the colour selected by pressing the control element briefly.  
– Once the configuration has been carried out, the guide light will blink 3 times.

#### 8- Changing the Power On level (optional setting)



Fig. 8:

The modification of the Power On level (luminosity connection after a grid failure) achieves a standard luminosity or disconnects all the service equipment connected with the luminosity value it had before the power cut.

To modify the Power On level, do the following:

1. Turn off the lighting (load).
2. Press the control element, hold it down and rotate it quickly three times from one side to the other.  
– The guide light blinks 3 times.
3. Release the control element.
4. Press the control element for 10 seconds.  
– After the configuration has been carried out, the lighting (load) will blink once and the guide light will blink 3 times.

The DALI service units will now be connected now with the return of the grid voltage with the last luminosity value set.

#### 9- Operation in various control stations

The DALI service units can be operated from various control stations. The luminosity is always taken from the last potentiometer used. This is valid for the rest of the configuration, such as the basic luminosity and the memory function.

The colour of the guide light has to be selected individually for each DALI potentiometer in an installation.

## Rotatory DALI dimmer & Rotatory DALI dimmer with power supply 8161.4 & 8161.5

### Electric connection

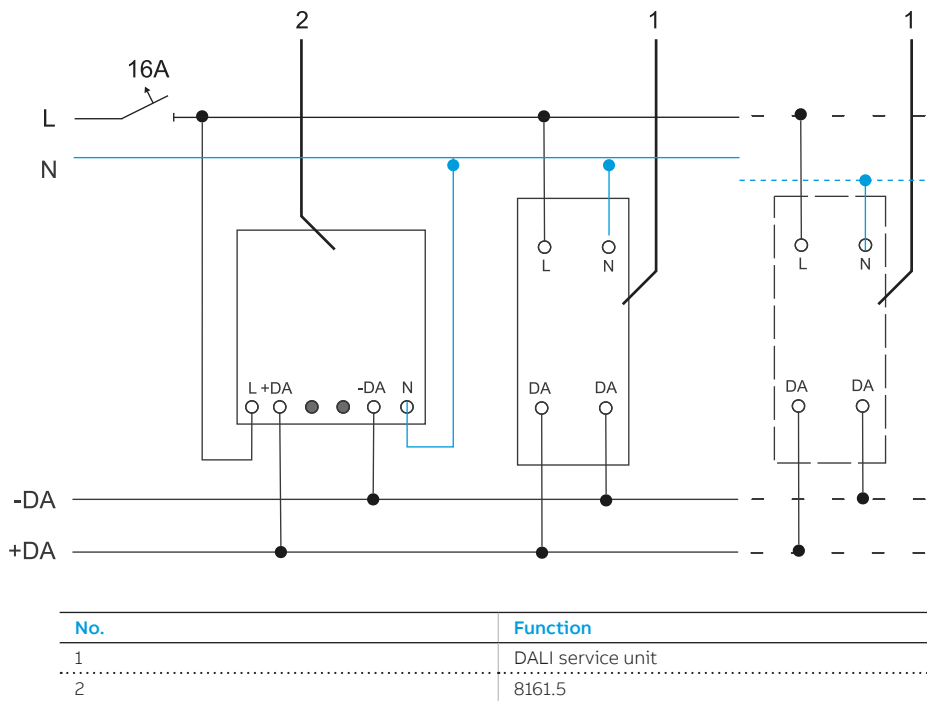
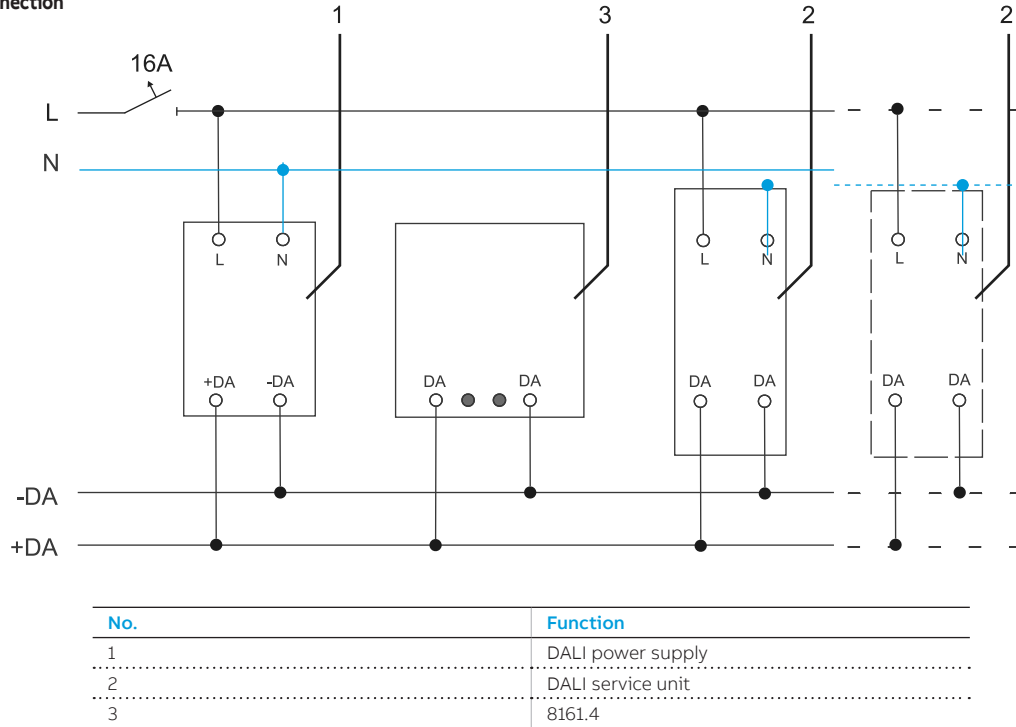

### Note:

- » If the potentiometer DALI 8161.4 is used in installations with a DALI power supply, terminals L and N cannot be occupied. The device is supplied directly with current from the bus.
- » Up to 3 DALI 8161.4 and 5 DALI 8161.5 potentiometers can be operated in parallel. For this purpose, observe the power consumption permitted.
- » When the DALI service units e.g., EVG are connected, observe the indications of the corresponding manufacturer.
- » The DALI control line and the power supply line can be found in a shared NYM cable.
- » Multi-phase service is permitted.

## Universal single relay time delayed switch

8130.1

230 V~ / 50 Hz; ±10%  
 ⚡ 2300 W  
 ⚡ 2300 VA  
 ⚡ 2300 VA  
 ⚡ 2300 VA

- Enables two operating modes selected with the front potentiometer: Switch Mode and Time-delayed Mode (30-300 s).
- For all types of loads.
- Range of ambient temperature: from 0 to +35°C.
- For manual operation exclusively, use the buttons Ref.: 8530, 8430, 8230 and 5530. (Fig. 2).

**Fig. 1**

8130.1 with auxiliary button 8104.5

**Fig. 2**

\* If you want to fit a night guide light, use the 8104.5.

## Universal double relay time delayed switch

8130.2

230 V~ / 50 Hz; ±10%  
 ⚡ 2 x 700 W  
 ⚡ 2 x 700 VA  
 ⚡ 2 x 700 VA  
 ⚡ 2 x 700 VA  
 Ⓜ 2 x 700 VA

- Enables two operating modes selected with the front potentiometer: Double switch mode and time-delayed disconnection mode of load 2, after the disconnection of load 1 (30-300 s).
- For all types of loads.
- Range of ambient temperature: from 0 to +35°C.
- For manual operation exclusively, use the buttons Ref.: 8530, 8430, 8230 and 5530. (Fig. 2) for time-delayed mode only.

**Fig. 1**

8130.2 with auxiliary buttons (8144.2, 8104.5) and two lamps.

**Fig. 2**

8130.2 with an auxiliary button (8104.5), a lamp and a motor. To control combinations of light and fans in bathrooms.

**Fig. 3**

\* If you want to fit a night guide light, use the 8104.5.

## Time delayed switch with relay

8162

- Power supply: 230 V~ / 50 Hz
- Maximum power:
  - ☀ 1.000 W
  - ⚡ 1.000 VA for  $\cos \varphi = 0,6$
  - ⚡ 650 VA

The time-delayed switch is an electronic mechanism that automatically disconnects the component controlled, within an adjustable time interval.

It is activated manually by pressing the button directly.  
Activation by remote control is with conventional auxiliary buttons.

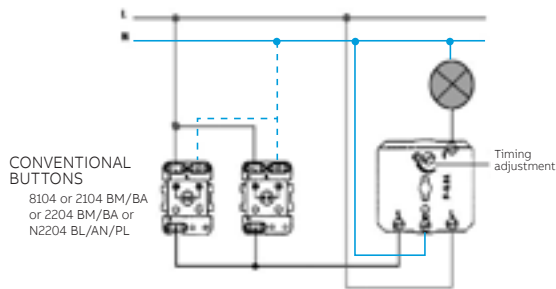

\* If you want to fit a night guide light, use the 8104.5.

- Protection against overcurrents: With calibrated fuse Code T5A. It is supplied with a spare.
- Protection against erroneous connections: With electronic device.
- Regulation time: From 10 s to 10 min.
- Night guide display: With red LED.
- Operating temperature: 0° to 40°C.
- Suppression of interference according to Standards: UNE-20507 and UNE-21806, EN 55014 and EN 60555.

## Time delayed switch with triac

8162.1

**Technical data:**

- Power supply: 230V~ ±10% / 50Hz
- Maximum power:
  - ☀ 40-500W for
  - ⚡ 40-400VA for
  - ⚡ 40-100VA for
- Protection against overcurrents: With calibrated fuse F-3, 15H. It is supplied with a spare.

Protection against erroneous connections: with electronic device.  
Regulation time: From 10 s to 10 min. (±10%).  
Night guide display: With red LED.  
Operating temperature: 0 to 40°C.

**Manufactured in accordance with the standards:**  
UNE-EN-60669-1 • UNE-EN-60669-2-1 • UNE-EN-60699-2-3

**Operation:** The time-delayed switch is an electronic mechanism that automatically disconnects the component controlled, within an adjustable time interval.

It is activated by pressing the button directly.

The desired margin of time for the disconnection of the device is regulated using the adjusting screw, indicated in Figure 1. The margin of time that can be set ranges between 10 seconds and 10 minutes (±10%).

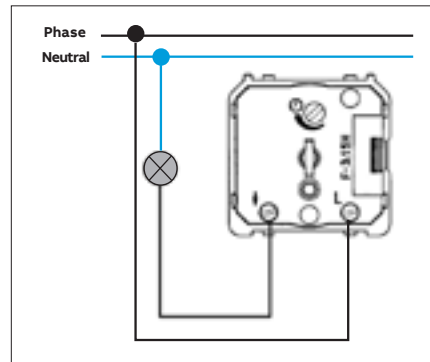

fig.1

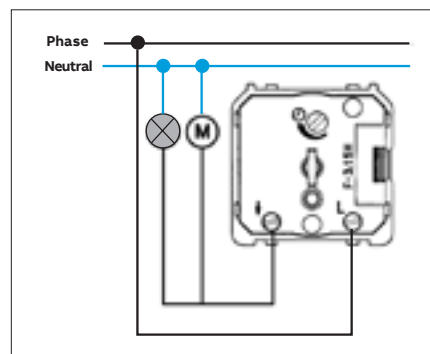



fig.2



## MOS-Fet switch for motion sensor

### Switch 8141.3

**Switch 8141.3**

Nominal voltage: 230 V~ 50 Hz.  
 Minimum nominal power: 60 W/VA  
 Maximum nominal power: 420 W/VA   
 Permitted load: incandescent lamps, halogen lamps at 230 V and halogen lamps with conventional and electronic transformers.  
 Protected against overloads and short circuit.

Operating temperature: From 0°C to 35°C.  
 Protection against short circuits with fuse Code M-4 A.

**Note:**

**Do not use the mechanism 8141.3 with contactors; in these cases use the 8141.4.**

**An auxiliary button (8104) can be connected, if you wish to operate the load manually.**

**Note: To use the 8141.3 in parallel, make sure the minimum load is increased by: no. of devices x 60 W**

In these applications, the light sources must be outside the detection area to prevent the disconnection due to a Sensor Switch being interpreted as a thermal variation by the other Sensor Switch, causing an unwanted connection.

\* If you want to fit a night guide light, use the 8104.5.

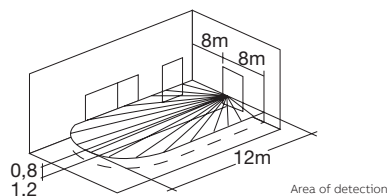
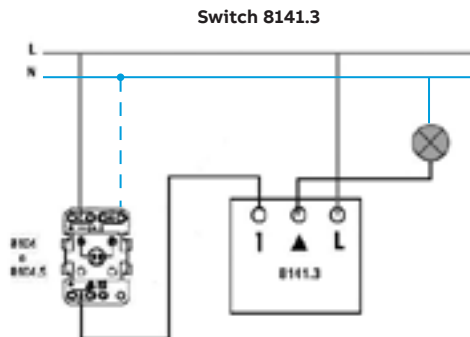

## Relay switch for motion sensor

### Switch 8141.4

Nominal voltage: 230 V~ / 50 Hz.  
 Maximum power: 700 W / VA  
 $3 A \cos \varphi = 0,5$   
 Permitted load:   
 All types of loads.  
 Operating temperature: From 0°C to 35°C

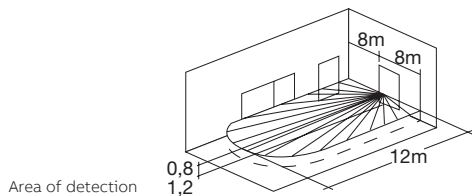
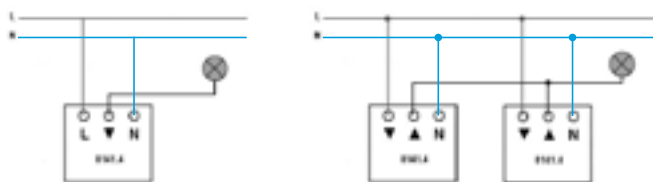

In these applications, the light sources must be outside the detection area to prevent the disconnection due to a Sensor Switch being interpreted as a thermal variation by the other Sensor Switch, causing an unwanted connection.

## Relay switch

8161

230 V~ / 50 Hz  
For all types of loads  
Power 2300 W/VA

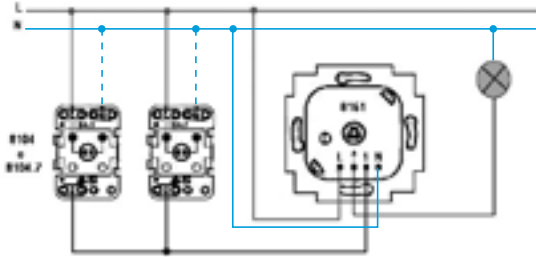

### Installation with auxiliary buttons

Device 8161 can be operated with auxiliary buttons. In these cases, the following aspects have to be taken into account:

- To avoid switching faults, the power supply lines of the motor and the auxiliary elements must not be in the same cable or next to each other (the minimum distance must be 5 cm).

The following auxiliary elements can be used:

- Conventional mechanical buttons with or without potential-free terminals.

### \* Attention:

If you want to fit a night guide light, use the 8104.5

To ensure proper operation, **separate the switching lines from the auxiliary activation lines (in different conduits).**

Can be combined with the IR button, with the programmer 8165.3 and with the presence sensor 9511.

## Relay switch for blinds

8161.2

Power 700W/VA  
I nominal - 3A casφ 0,5  
Power consumption ≤ 1W  
Max I per aux. input ≤ 3 mA

View of the whole unit

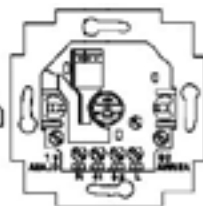
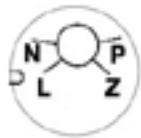

Individual control

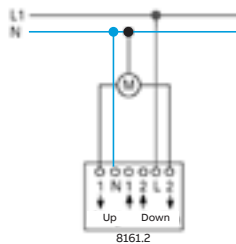

Centralised control

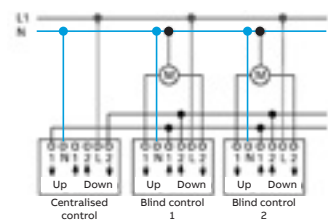

The IR button 8439.XX and the programmer 8165.3 can control a group of blind motors by operating the auxiliary inputs ("1" and "2") of the blind control device. Using a two-pole switch for blinds, the group of blinds can be moved manually or the sensor can be activated for periods of absence.

The recessed device 8161.2 is used to control:

- » Blinds with mobile slats.
- » Rolling blinds.
- » Awnings.
- » Closures with motorised domes or vaults, etc.

In this instruction manual the term "blind" or "blinds" as synonyms of the applications mentioned in the above paragraph.

Mechanism that can be combined with the programmer 8165.3

### Service modes

#### Normal service (N) = factory setting

Example of use: "normal" activation of the blind.

One short press activates the order of actuation that activates the blind to its final position (up or down). A long press (holding it down) activates a regulation command. The output will remain permanently connected throughout the setting using the control element/extension.

If the regulation lasts more than three minutes, the recessed application will be disconnected.

#### Regulation of slats (L)

Example of use: "normal" activation of the blind and regulation of slats in small stages. The short press is identical to that of normal service. The output is regulated in steps during adjustment using the control element/extension. After the eighth step or 2 seconds the adjustment ends.

#### "Central" (Z)

Example of use: a recessed control blind application is used as a central unit for other blinds. Each press (short or long) of this central unit is interpreted and converted into a 3-minute activation command. This ensures that all the subordinate blinds reach the final position.

#### Programming (P)

Example of use: in the event of a command to lower, the blind must automatically be lowered and the slats regulated.

## Timer control element + Cover plate for timer control element

8165.31 + 8565.3

Loads that are usually automated/programmed:

- » Porch lights
- » Garden lights
- » Lights in corridors in schools, universities, shops, etc.
- » Blinds in a house
- » Shop awnings
- » Alarm activation
- » Heating or air conditioning
- » A small wake-up alarm (next to the bell)

For all these applications there are two construction types for the function:

- 8161+8165.31+8565.3:

To function as a relay switch.

- 8161.2+8165.31+8565.3:

To function as a relay switch for blinds, awnings, etc. Enables slats to be regulated, all the blinds to be centralised from one point and awnings to be operated.

**See diagrams of relay switches.**

### Service modes

The control element has three service modes that you can select freely.

- "MANUAL" (symbol )= The automatic connection intervals, and the luminosity and twilight functions (with the blinds) are not executed. Exclusive control with the buttons ▼ or ▲.

RAISE blind ▲

Short press:

- The blind moves toward the final upper position.
- When pressed again, the blind stops.

Long press:

- The blind is raised while the button is being pressed.

LOWER blind ▼

Short press:

- The blind moves toward the final lower position.
- When pressed again, the blind stops.

Long press:

- The blind is lowered while the button is being pressed.

- "AUTOMATIC" (symbol **AUTO**) = Automatic control according to the selected programme: Astro, day-week, connection times. Manual control with the buttons ▼ or ▲ is also possible.

- "HOLIDAYS" (symbol )= control as in automatic service. A random number generator moves the connection intervals up to 30 minutes each day to simulate the presence of a person in the home. Manual control with the buttons ▼ or ▲ is also possible.

### Types of connection

The control element can work with three different types of connec-

tion: "daily clock newspaper", "weekly clock" or "weekly clock with Astro device".

- **Daily clock:** When programming the connection times, the day of the week cannot be selected. Thus, the times you programme are repeated every day.

- **Weekly clock:** When programming the connection times, the days of the week are available (1 for Monday up to 7 for Sunday.) Thus it can be programmed differently for each day of the week.

- **Weekly clock with Astro:** Together with the programming of the days of the week, it is possible to activate the Astro function with each connection time.

### Indications on the display

1 Current weekday / info line.

2 Info line / date.

3 Operating mode.

4 Time / switching time.



5 Display on the blind insert: Arrows up down during movement time;

Display on the light insert:

OFF / light value in %;

Display on the relay insert: ON / OFF.



Button	Function	In setting mode	Adjusting values	Reset to factory setting
	Calling up menu level and switching to setting mode	Return to operating mode		In operating mode press all buttons of the rocker switch simultaneously for approx. 5 seconds.
	Blind UP/ Light ON (brighter)/ Electric load ON	Select menu item	Adjust values	
	Blind DOWN/ Light OFF (darker)/ Electric load OFF			
<b>OK</b>	Switching operating modes, Switching times today, Displaying sensor values, Confirmation.	Select menu	Accept value	

## Link for button with battery and wireless switch actuator

8531.X & 8130.4

### 1- Selecting the functioning of the button with battery

The battery transmitter must have Switch operation mode (mode 2) selected.

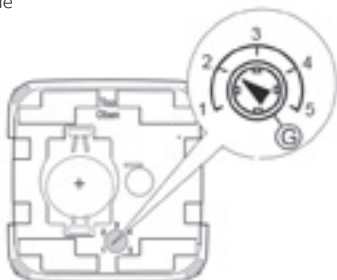

### 2- Configuring the wireless receiver actuator

The wireless receiver actuator basically offers two operating modes:  
a) Switch mode: Potentiometer position "INT"  
b) Time-delayed switch mode: We can time the disconnection of the actuator to the desired time, 3 s, 1 min, 5 min, 15 min.

To select the actuator operating mode, turn the potentiometer so that it points to the corresponding position.

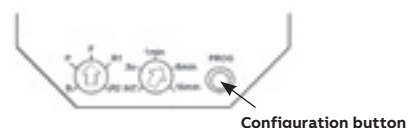

## Link for button with battery and wireless switch actuator

8531.X & 8130.4

### 2.1.- Configuring a link between transmitter and receiver channel of the wireless actuator.

Details are provided below on the association between a transmitter (wireless button, wireless touch control, wireless motion sensor, etc.), and the receiver channel of the wireless actuator.

Turn the potentiometer of the wireless actuator to the position "P". The LED of the configuration button will blink slowly in red.

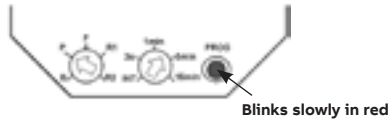

### 2.2.- Press the configuration button; the LED of the configuration button will blink quickly in red.



At this moment the wireless actuator is waiting to accept a link with a transmitter channel. (wireless button, wireless touch control, wireless motion sensor, etc.).

### 2.3.- Linking with the transmitter channel:

- to link with the button with battery, press the lower part of the button briefly. The LED of the button will remain red for a few seconds and go off.
- to link with a touch control.
- wireless motion sensor.

### 2.4.- Place the transmitter and receiver in operation mode:

- Turn the potentiometer of the battery to position "3"

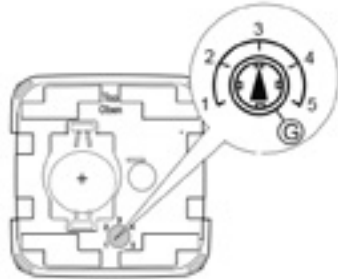

- Turn the potentiometer of the chip to position "F"

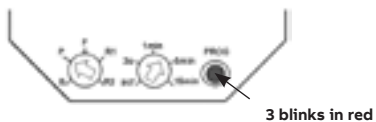
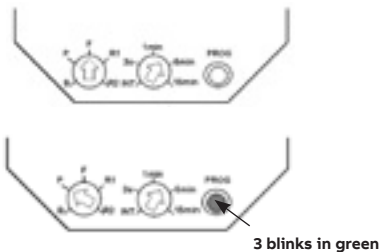

### 2.5.- To act on the load: Short and long presses turn on/off.

### 3- Deleting a link from the receiver channel of the wireless actuator

#### 3.1.- Turn the potentiometer of the wireless actuator to the position "Rst 1", link erase mode.



#### 3.2.- Press the configuration button for approximately 8-10 seconds; The LED of the configuration button will blink quickly in red.

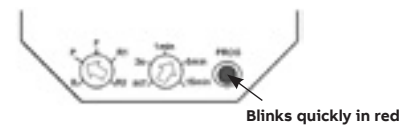

#### 3.3.- Turn the potentiometer of the wireless actuator to the position "Rst 2", link erase mode. If the link has been deleted successfully, the wireless actuator will leave configuration mode and the configuration button will blink in green 3 times.

#### 3.4.- Press the configuration button for 4 seconds; The LED of the configuration button will blink quickly in red.

#### 3.5.- If the link has been deleted successfully, the wireless actuator will leave configuration mode and the configuration button will blink in green 3 times.

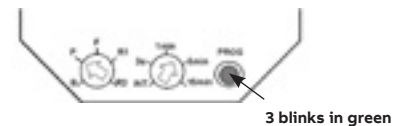

If the link has not been deleted successfully, the wireless actuator will leave configuration mode and the configuration button will blink in red 3 times.

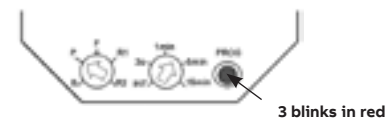

Similarly if after one minute there is no attempt to establish an association for the deleted link, the wireless actuator will leave configuration mode automatically.



## Link for button with battery and wireless dimming actuator

8531.X & 8130.5

### 1- Selecting the functioning of the button with battery

The battery transmitter must have regulation operation mode (mode 4) selected.

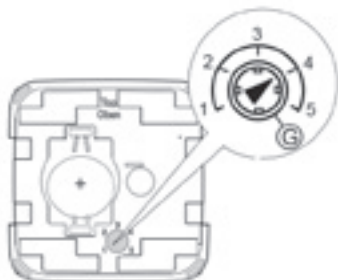

### 2- Configuring the wireless receiver actuator

The wireless receiver actuator basically offers two operating modes:

- a) Switch mode: Potentiometer position "INT"
  - b) Time-delayed switch mode: We can time the disconnection of the actuator to the desired time, 3 s, 1 min, 5 min, 15 min.
- To select the actuator operating mode, turn the potentiometer so that it points to the corresponding position.



### 2.1.- Configuring a link between transmitter and receiver channel of the wireless actuator.

Details are provided below on the association between a transmitter (wireless button, wireless touch control, wireless motion sensor, etc.), and the receiver channel of the wireless actuator.

Turn the potentiometer of the wireless actuator to the position "P". The LED of the configuration button will blink slowly in red.



2.2.- Press the configuration button; the LED of the configuration button will blink quickly in red.



At this moment the wireless actuator is waiting to accept a link with an transmitter channel. (wireless button, wireless touch control, wireless motion sensor, etc.).

- 2.3.- Linking with the transmitter channel:
- to link with the button with battery, press the lower part of the button briefly. The LED of the button will remain red for a few seconds and go off.
  - to link with a touch control.
  - wireless motion sensor.

2.4.- Place the transmitter and receiver in operation mode:

- Turn the potentiometer of the battery to position "3"

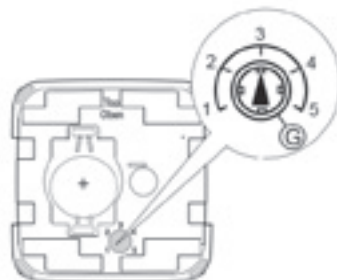

- Turn the potentiometer of the chip to position "F"



- 2.5.- To act on the load:
- Short press up, turn on
  - Short press down, turn off
  - Long press up, regulate upward
  - Long press down, regulate upward

### 3- Deleting a link from the receiver channel of the wireless actuator

3.1.- Turn the potentiometer of the wireless actuator to the position "Rst 1", link erase mode.



3.2.- Press the configuration button for approximately 8-10 seconds; The LED of the configuration button will blink quickly in red.



3.3.- Press the configuration button for 4 seconds; The LED of the configuration button will blink quickly in red.

## Link for button with battery and wireless blind actuator

8531.X & 8130.7

### 1- Selecting the functioning of the button with battery

The battery transmitter must have blinds operation mode (mode 1) selected.

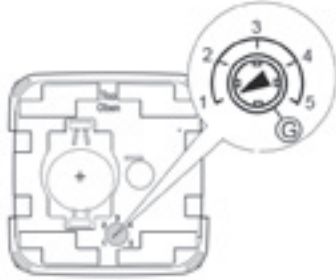

### 2- Configuring the wireless receiver actuator

The wireless receiver actuator basically offers two operating modes:  
 a) Switch mode: Potentiometer position "INT"  
 b) Time-delayed switch mode: We can time the disconnection of the actuator to the desired time, 3 s, 1 min, 5 min, 15 min.  
 To select the actuator operating mode, turn the potentiometer so that it points to the corresponding position.



Configuration button

### 2.1.- Configuration of a link between transmitter and receiver channel of the wireless actuator.

Details are provided below on the association between a transmitter (wireless button, wireless touch control, wireless motion sensor, etc.), and the receiver channel of the wireless actuator.

Turn the potentiometer of the wireless actuator to the position "P1". The LED of the configuration button will blink slowly in red.



Blinks slowly in red

2.2.- To link with the button with battery, press the upper part of the button briefly. The LED of the button will remain green for a few seconds and go off.



Blinks quickly in red

At this moment the wireless actuator is waiting to accept a link with an transmitter channel. (wireless button, wireless touch control, wireless motion sensor, etc.).

2.3.- Turn the potentiometer of the wireless actuator to the position "P2". The LED of the configuration button will blink slowly in red.

2.4.- To link with the button with battery, press the lower part of the button briefly. The LED of the button will remain green for a few seconds and go off.

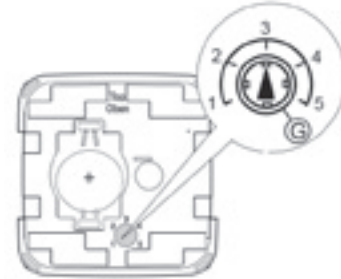

3 blinks in green



3 blinks in red

2.5.- Place the transmitter and receiver in operation mode:

- Turn the potentiometer of the battery to position "3" (image of dial instructions)

- Turn the potentiometer of the chip to position "F" (image of chip)

2.5-To act on the load:

Short press: If the blind is moving, it will stop. And if the blind is stopped, it will be raised/lowered one step or the slats rotated.

Long press: Raises/lowers the blind for the programmed time, with the selector with the electronic mechanism.

### 3- Deleting a link from the receiver channel of the wireless actuator

3.1.- Turn the potentiometer of the wireless actuator to the position "Rst 1", link erase mode.



LED in red

3.2.- Press the configuration button for approximately 8-10 seconds; The LED of the configuration button will blink quickly in red.



Blinks quickly in red

3.4.- Press the configuration button for 4 seconds; The LED of the configuration button will blink quickly in red.

### Wireless switch actuator

8130.4

230 V~ / 50 Hz  
 ☀ 2300 W / VA  
 ⚡ 2300 W / VA  
 ⚡ 2300 W / VA  
 ⚡ 1000 VA

- Transmission frequency: 868 MHz.
- Allows two operating modes:
  - Switch and time-delayed from 3 s to 15 min.
- One auxiliary input and one relay output.
- It has a potentiometer to select the operating modes and for configuration.
- Dimensions: 47 mm. x 48 mm. x 22 mm.

### Wireless dimming actuator

8130.5

230 V~ / 50 Hz ±10%  
 ☀ 25-350 W / VA  
 ⚡ 25-350 W / VA  
 ⚡ 25-350 W / VA

- Transmission frequency: 868 MHz.
- Allows 4 operating modes:
  - Universal, type C loads, L loads and ESL loads.
- An auxiliary input and adjustable output.
- It has a potentiometer to select the operating modes and for configuration.
- Dimensions: 47 mm x 48 mm x 30 mm
- Suitable for most low consumption LED lamps with phase-cut dimmers.

### Wireless blind actuator

8130.7

230 V~ / 50 Hz ±10%

- Allows two operating modes:
  - 2 independent relays:
    - 2 x 700 W/VA.
    - Nominal current 3AX.
- Use of contactors in installations with fluorescents is recommended.
- Blinds: - 700 W/VA
  - 3AX

Installation of 2 Loads

Installation of Blinds

### Wireless DIN-rail actuator

8130.6

230 V~ / 50 Hz  
 ☀ 2300 W / VA  
 ⚡ 2300 W / VA  
 ⚡ 2300 W / VA  
 ⚡ 1000 VA

- Transmission frequency: 868 MHz.
- Allows two operating modes:
  - Switch and time-delayed from 3 s to 30 min.
- It has a potentiometer to select the operating modes and for configuration.

### 4 position rotatory switch

8154

4 positions and 4 circuits.  
 The connection must be made with "Faston" type terminals.

		SEQUENCE OF CONNECTIONS			
		0	1	2	3
CIRCUITS	1	●	●	●	●
	2	●	●	●	●
	3	●	●	●	●
	4	●	●	●	●

# Digital room thermostat

## 8140.5

**Technical data:**

**Power supply:** 230 V~ ± 10%, 50 Hz for ref. 8140.5  
 127 V~ ± 10%, 60 Hz for ref. 8840.5  
**Consumption:** < 1 W

**Usage temperature:** From 0°C to 50°C.  
 » Accuracy of the measurement: ± 2°C (± 1°C with calibration)  
 » Resolution: 0.1°C.

**Control output:** Voltage-free relay contacts (NO)  
 » Maximum load: 3 A cos φ = 0.5

**Operating mode of the output relay:**  
 » Hysteresis: 0.5°C.  
 » Pulse width modulation: With a difference of ± 4°C compared to the setpoint temperature, variable from 100% to 0% modulation.

This control makes it possible to control heating and cooling devices (not simultaneously) using its internal electronic thermostat. The thermostat can be calibrated in situ.

» **Nocturnal operating mode “☾”:**  
 Based on establishing a difference between day and night temperatures (from 0°C to 5°C) with the purpose of saving energy.

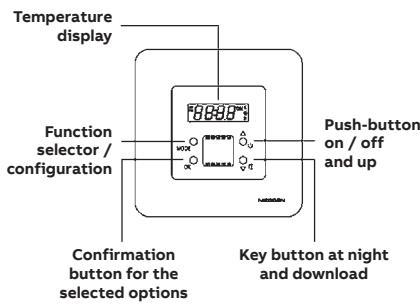

**Connection diagram:**

For heating and cooling installations with non-potential-free input.

For heating and cooling installations WITH potential-free input.

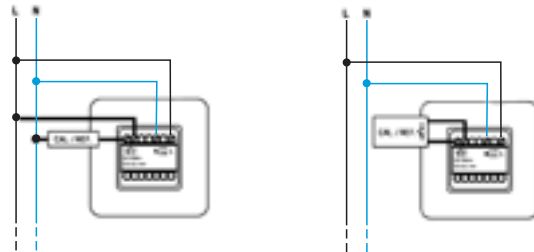

- » **Winter mode “☀”:**  
Selected when the unit controlled is a heating unit.
  - » **Summer mode “☁”:**  
Selected when the unit controlled is an air conditioning unit.
  - » **Temperature regulation by hysteresis:**  
In this operating mode of the output, the unit to be controlled is working constantly until it reaches the setpoint temperature, at which point it is disconnected and will not be re-activated until the ambient temperature is more than 0.5°C from the setpoint.
  - » **Temperature regulation by pulse width:**  
With this configuration of the output type, the unit to be controlled is working constantly up to ± 4°C of the setpoint temperature. From this moment, a cyclical series of switching the unit on/off (varying the ratio of time ON-OFF) until the setpoint temperature is reached. The use of pulse width regulation is especially recommended for electrical heating, heat pumps and electrothermic actuators.
- Attention:** To regulate between hysteresis and pulse width, the thermostat must not be on, in other words the “ON” must not be shown on the display.

In cases in which it is important to avoid a frequent change between switching on and off, for example in gas boilers, temperature regulation by hysteresis should be used, which is selected by default in the thermostat.

# Floor thermostat

## 8140.9

**1. Technical data**

**Voltage:** 230V~ +/-10% 50-60Hz  
**Load power:** 2.300W.  
**Load type:** floor heating resistor.  
**Control temperature:** +5°C to +45°C (Set point).  
**OFF state:** at OFF position, the thermostat is off, so that it does not address the temperature measured by the floor temperature probe. The relay output contact is open.  
**Temperature accuracy:** 0,5°C.  
**Hysteresis:** 0,5°C.  
**Floor temperature sensor:** NTC, 10KΩ at 25°C, -40°C to 80°C. Double isolated cable, 4m length.  
**LED light indication:** red and green  
**Ambient temperature:** -20°C to 45°C

**2. Installation**

In order to get the better temperature measurement performance possible at the floor thermostat installation, it is recommended:

- Install the thermostat higher than 1m height from the floor.
- Do not install the thermostat near other heat or cold sources.
- Keep the floor temperature sensor away from interference sources or power circuits.
- Check the floor temperature sensor is correctly connected.

**3. Connection**

**Important:** Disconnect the mains voltage power when installing. Work on the 230 V supply system may only be performed by specialist staff! Disconnect main power supply prior to installation and/or disassembly!

**4. Operation**

The temperature set point can be adjusted by the rotary knob on the front of the thermostat, from +5°C to +45°C.

LED light in the front, indicates the following:

- Red color: Temperature set point is higher than measured temperature at floor sensor. Relay output contact is closed.
- Green color: Temperature set point is lower than measured temperature at floor sensor. Relay output contact is open.
- LED off: Thermostat is OFF state (disconnected).
- Blinking red color: (a) The floor temperature sensor would not be connected or (b) the temperature read by the floor temperature sensor is below -40°C. Relay output contact is closed.

**5. Guarantee**

This product is subject to the guarantee offered in the selling general terms of ABB in each country.

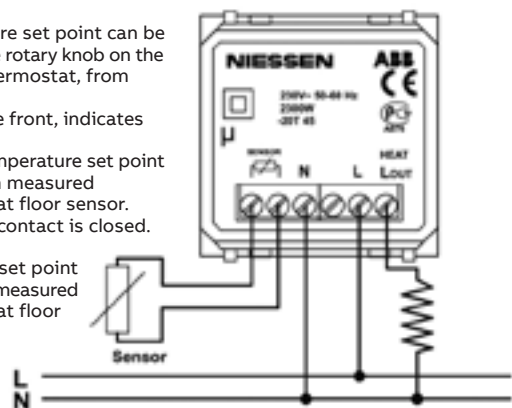



## LED signaling light

8180.1

230 V~ / 50 Hz.

- » Suppression of interference according to standards UNE-21806 and EN-55014
- » At a distance of 1 metre, it provides a light flux greater than 2 lumen.

The indicators will light up provided they are connected to the grid voltage and this maintains its nominal voltage value. These electronic mechanisms do not have rechargeable batteries or auxiliary energy sources, for cases in which the grid voltage falls below the nominal value or 0 V.

The device is installed with a universal box for recessed mounting, with the same electrical connections shown in the figure. Disconnect the grid voltage while installing the device.

### Connection of the Indicator light.

(Figure 11)

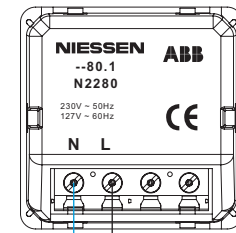

Connection of the device



## LED DND/MUR signaling light

8180.2

230 V~ / 50 Hz.

- » Suppression of interference according to standards UNE-21806 and EN-55014
- » At a distance of 1 metre, it provides a light flux greater than 2 lumen.

The pass/wait indicator is a device that is connected to the grid voltage and is able to indicate with a green or red LED light, the wait or pass where it is located. Installed in conjunction with a conventional switch, it makes it possible to have an indicator to indicate free or restricted passage, as relevant at any time (Figure 1).

In addition it can be installed with a switch that has three possibilities, thus allowing standby status, signalling free passage, and restricted passage (Figure 2).

### Connection of pass/wait indicator.

(Figure 1)

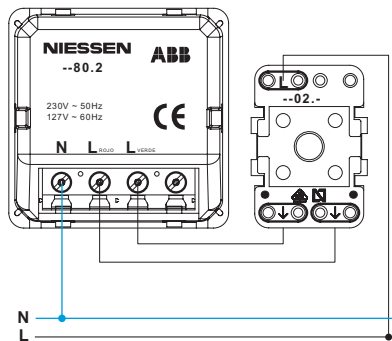

Connection of the device

N

L

### Connection of pass/wait indicator.

(Figure 2)

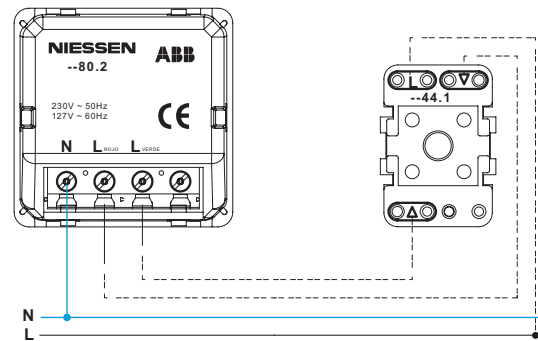

Connection of the device

N

L

## Beacon LED light

8181.2

### 1.- Introduction

The standard marker light is an autonomous indication device, with a battery for accumulating electrical energy, which guarantees the correct indication lighting of the communication routes of buildings in the event there is a power cut or when this falls below 70% of its nominal value (230 V).

### 2.- Technical Specifications 230 V~ / 50 Hz.

- » Alert indication: This can be selected with the selector.
  - lighting in blue or
  - lighting in white
- » Emergency lighting: high luminosity white.
- » Nickel-Metal Hydride (NI-MH) battery, which currently have the lowest environmental impact.
- » Autonomy: 3 hours, of which 1 h at maximum lighting. 2 h at lower lighting.

**Remote control:** Allows any type of component standardised regarding voltages.

- » Compliant with the following regulations:
  - RD 2816/1982 (BOE 6-11-92): General regulation of the police. Art. 15.2
  - RD 314/2006 (BOE 28-03-06) Technical Building Code Section SU4. Sec. 2.2 Position and characteristics of lights. Sec. 2.3 Installation characteristics.
  - REBT 2002, ITC-BT-28, section 5-g. UNE-EN60598-2-22
- » Suppression of interference according to standards UNE-21806 and EN-55014.
- » At a distance of 1 metre, it provides a light flux greater than 2 lumen.

## Beacon LED light

### Autonomous LED marker light. 8181.2

#### 3.- Installation

- » Connect, fit and secure the marker lights to the box (square or circular with 60 mm between screws).
- » For greater protection in public premises, the external part of the unit can be affixed with two screws, thus the external parts of the unit are secured more firmly, thus protecting against vandalism.

See assembly in Figures 1, 2 and 3:

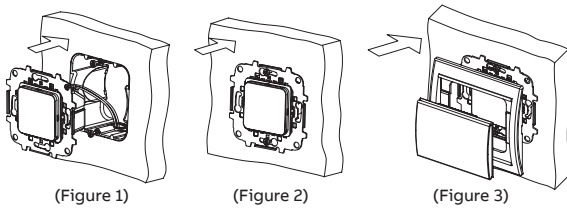

- » Separate the diffuser support from the cover to be able to secure it to the marker light with the screws.

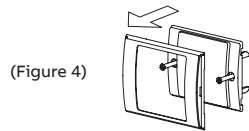

- » Once the beacon has been secured to the box, position the frame and secure the diffuser support to the marker light.

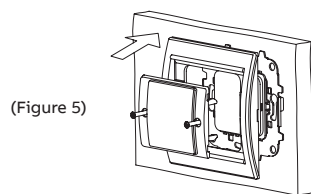

- » Fit the cover and the trim onto the diffuser support.

(Figure 6)

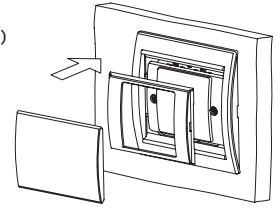

#### 4.- Connection

The device is installed with its universal box for recessed mounting, with the same electrical connections shown in the figure.

Disconnect the grid voltage while installing the device.

(Figure 7)

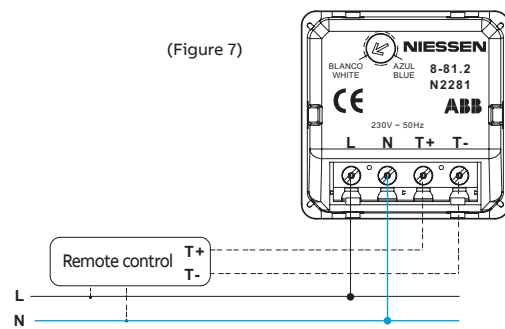

Connection of the device

\* The voltage of the remote controls may be 9, 13 or 24 Vdc.

## Electronic bell

### N2224.-XX

#### 1. Technical data

##### Power Supply

- N2224.1: 127V~ ; 60Hz
- N2224: 230 V~ ; 50-60 Hz

#### 2. Mounting and connection scheme

##### 2.1. Connection

**Important:** Disconnect the mains when installing.

Connection with Niessen push buttons

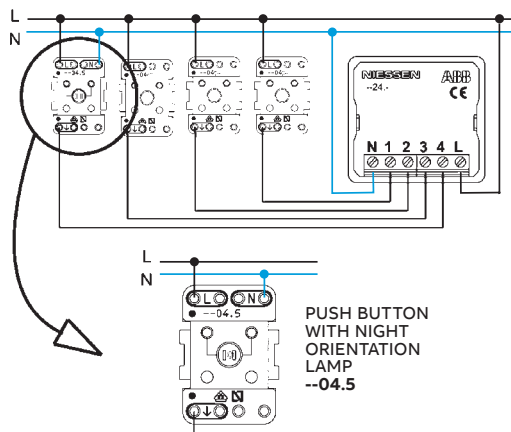

#### 3. Operation

The bell can be connected to 4 push buttons maximum, with a different melody for each one of them.

#### 4. Warranty

This product is subject to the warranty offered in the general conditions of sale of ABB in each country.

Connection with conventional push buttons

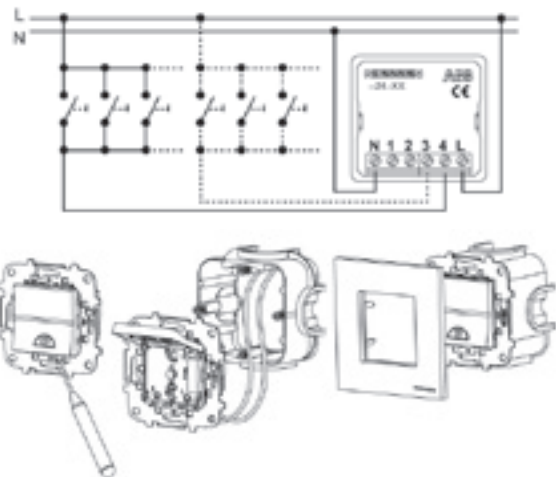

## FM stereo receiver with alarm module

9368 & 9368.7

**1. Technical data**

**Rated voltage:**  
 - 9368: 230 V~; ±15%; 50-60 Hz  
 - 9368.7: 127 V~; ±15%; 50-60 Hz

**Max. consumption:** 100 mA

**Stand-by consumption ref. 9368 and 9368.7 (\*):** 0,2 W.

**Stand-by consumption ref. (9368 or 9368.7) + 9368.3 (\*):** 0,5 W.  
 (\*) With the display illumination at minimum.

**Maximum output power:** 2+2 W; <1% distortion (16 W)

**Speaker impedance:** 16 W (2+2 W audio)

**2. Wiring diagram:**

(\*) FM RECEPTION  
 The FM indoor antenna that incorporates the module 9368 or 9368.7, uses the electrical network to improve reception. If the reception is not quite right, you can connect an external FM antenna (thin wire or coaxial wire) in the connectors enabled for it.

**3. Mounting:**

1.- Mounting plate  
 2.- Insert 9368/9368.7  
 3.- Frame  
 4.- Cover plate - 8586

9368.3  
Audio input/output module + USB and Bluetooth® (OPTIONAL)

## Auxiliary module

9368.3

**1. Technical data**

**Power supply through AUX.:** 9 V

**Maximum consumption:** 175 ~ 200 mA

**Consumption stand-by:** 0.4 W

**Headphones impedance:** 16 ~ 600 Ω (25 + 25 mW audio phones)

**Bluetooth®:** Bluetooth® v2.1 2.4GHz IEEE 802.15.1  
 Maximum reach from the module 9368.3 to user's Bluetooth® device: 10 m.

**2. Wiring diagram:**

9368, 9368.7 or 9308.2  
Wall module

9368: 230 V~; ±15%; 50-60 Hz  
 9368.7: 127 V~; ±15%; 50-60 Hz  
 9368.2: 127/230 V~; ±15%; 50-60 Hz

9368.3: Input/output module of audio + USB and Bluetooth®

**3. Mounting:**

1.- Mounting plate  
 2.- Insert 9368.3  
 3.- Frame  
 4.- Cover plate - 8586.3

**REAR VIEW**

**FRONT VIEW**

USB socket (max. 100 mA; 5 V)

Audio input (MP3, discman, PC...)

Headphone socket

9368.3: Input/output module of audio + USB and Bluetooth®

# Radio & Bluetooth multiroom module + Remote control module

9368.1 & 9368.2

### 1. Technical Data

**Power supply:**

230 V~ / 127 V~; ±15%; 50-60 Hz

**Bluetooth®:**

Bluetooth® v2.1 2.4GHz IEEE 802.15.1  
 Maximum reach from the ceiling module  
 9368.1 to user's Bluetooth® device: 10 m.

**Maximum power consumption:**

200 mA

**Consumption stand-by:**

0.3 W

**Communication data:**

ZigBee 2.4GHz IEEE 802.15.4

**Antenna impedance:**

75 Ω

**Maximum power headphone output**

6+6 W; <1% distortion (4 Ω)

**Minimum impedance of headphones:**

4 Ω (6+6 W audio)

### 2. Wiring diagram:

BUS MULTIROOM is only necessary if there is more than one room in the house and/or you want to connect the rooms in the house.

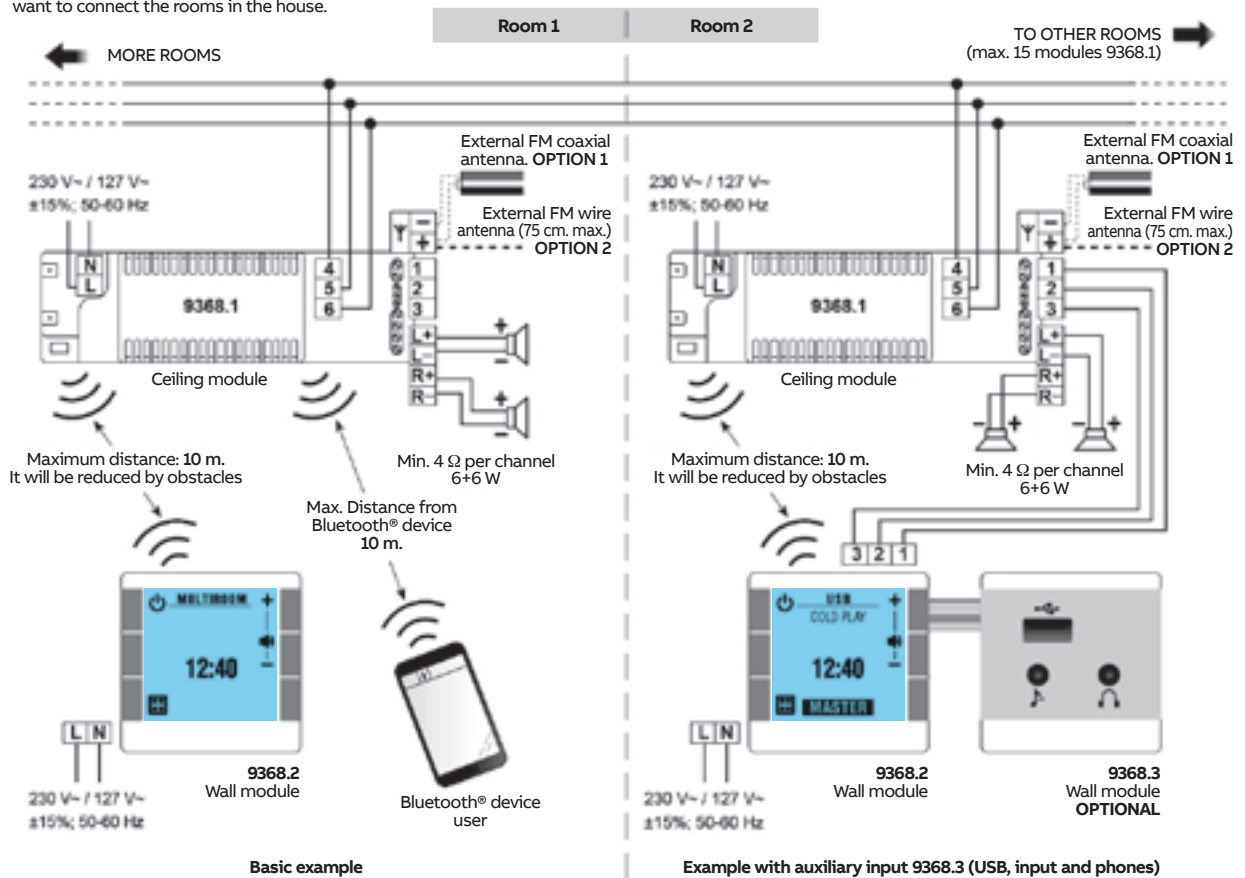

**NOTE:** Because these devices are radio frequency and to avoid interference, you should not install modules of the same reference or any other RF equipment that could interfere less than 1 m. away. It should be noted that any obstacle between the devices, can significantly reduce the distance range between them.

### 3. Mounting:

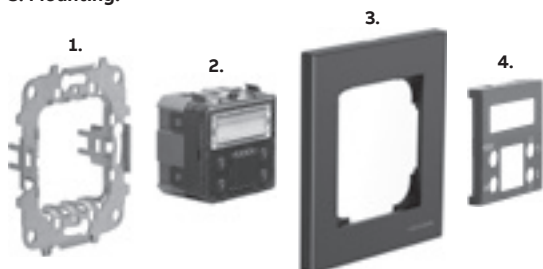

1. Mounting plate
2. Insert - 9368 / 9368.7
3. Frame
4. Cover plate - 8586



# Sound amplifier - Connection to multiroom module

9335.1 - 9368.1

Wiring diagram of 9368.1 module to 9335.1 sound amplifier

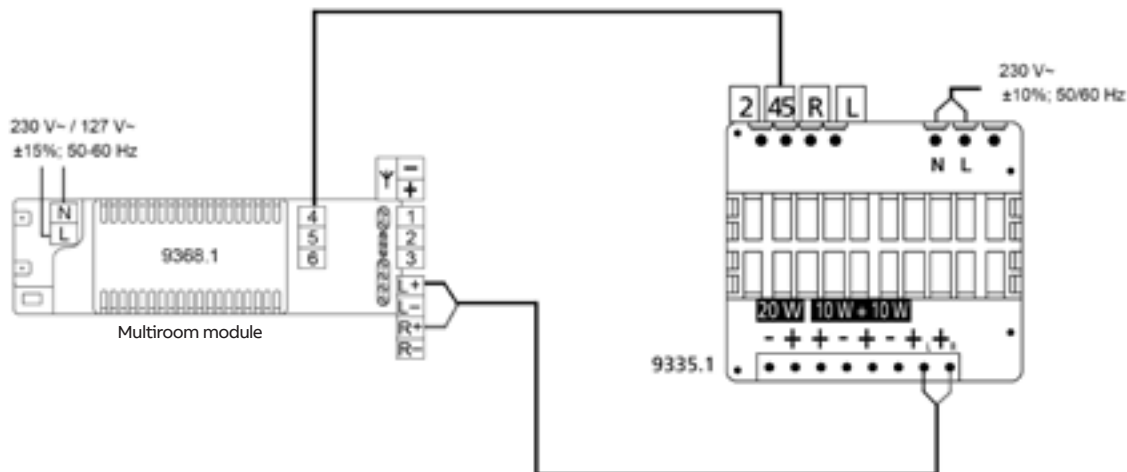

Wiring diagram for 9329.1 loudspeakers to 9335.1 sound amplifier

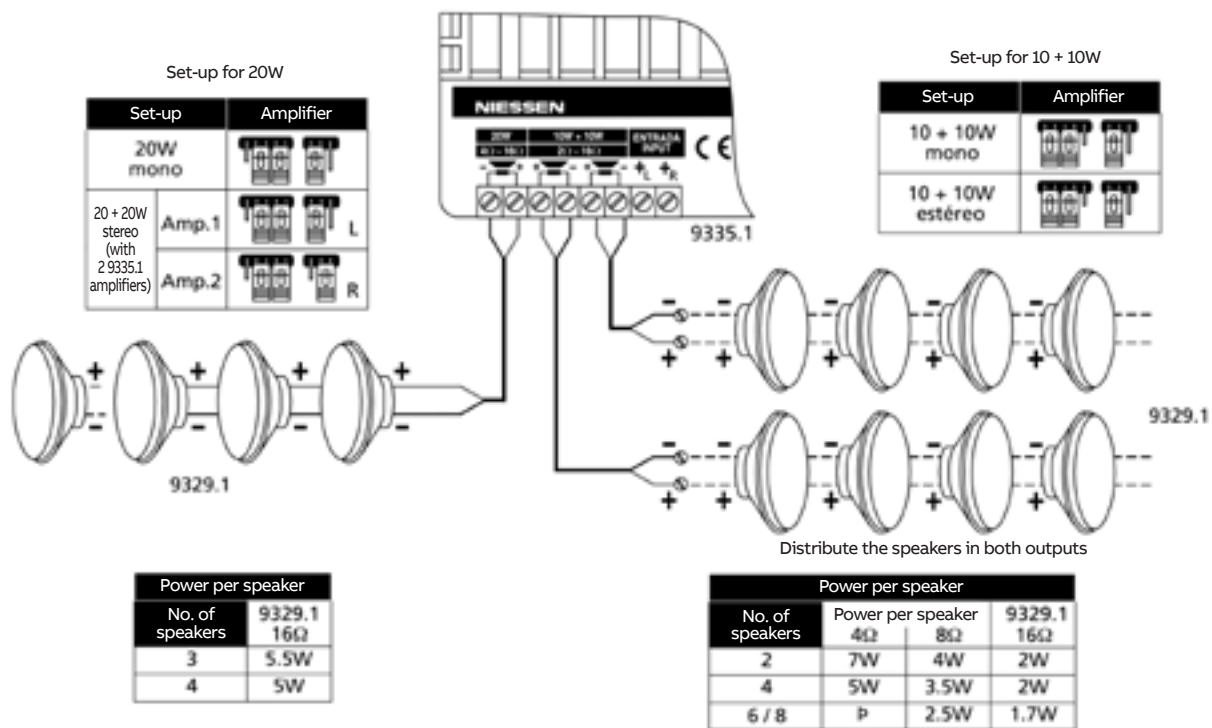

## Dimensions

### Sky Niessen

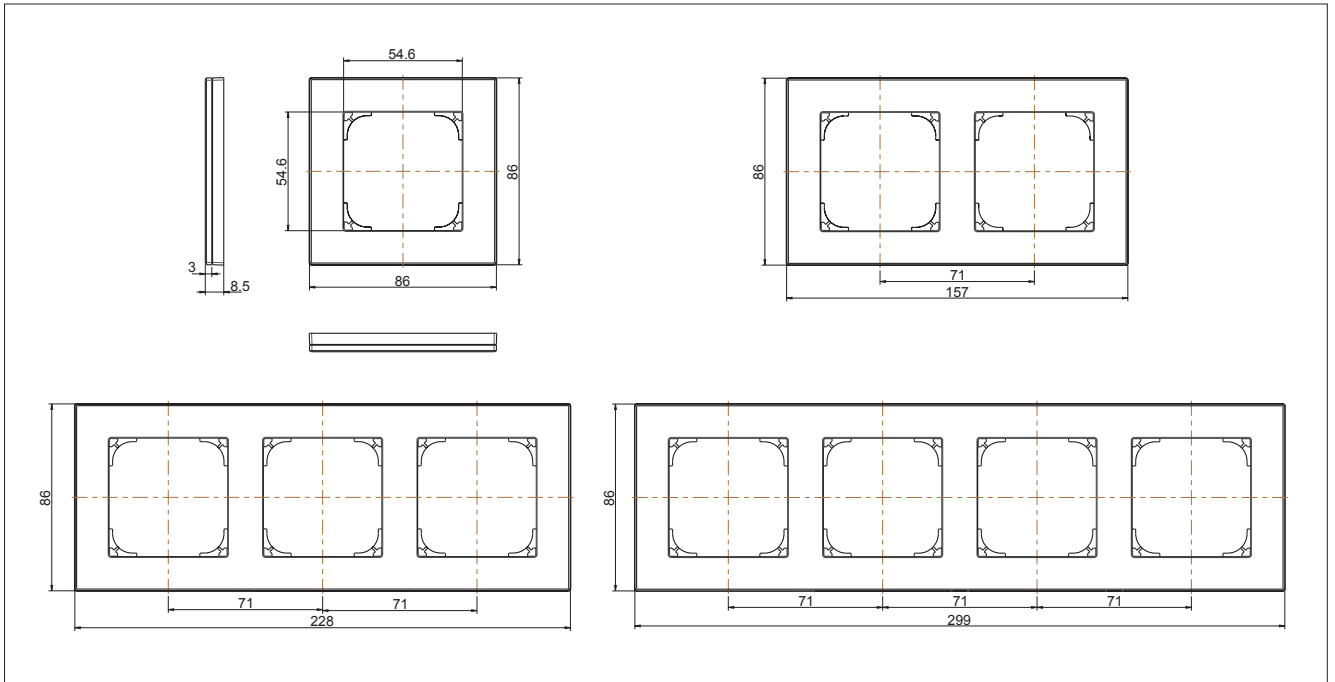

### Skymoon

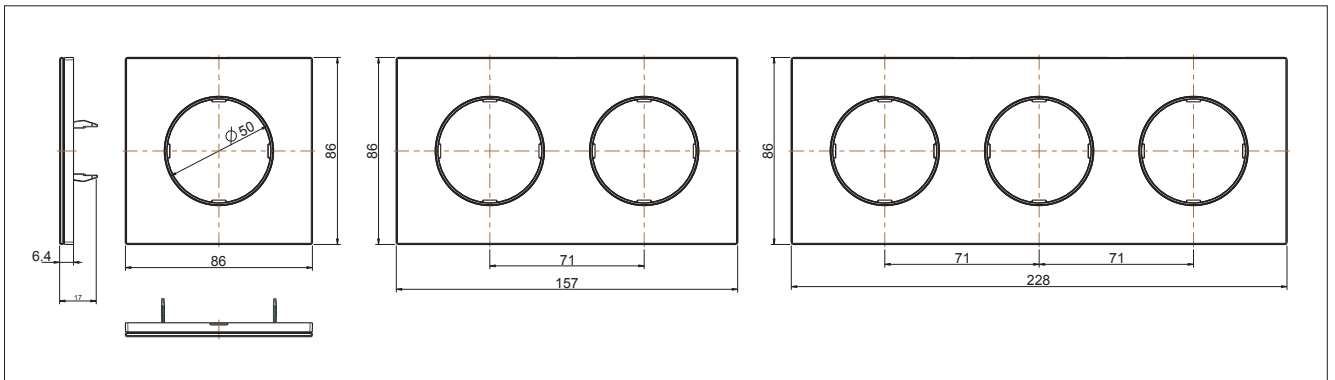

### Boxes for flush mounting

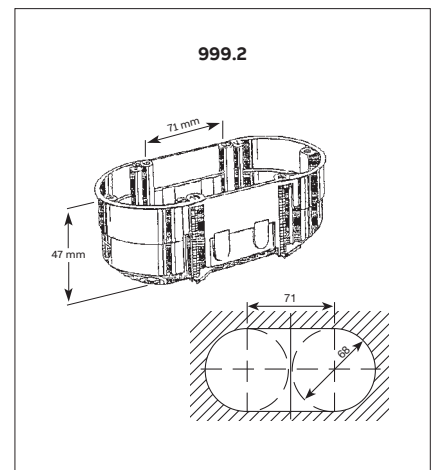
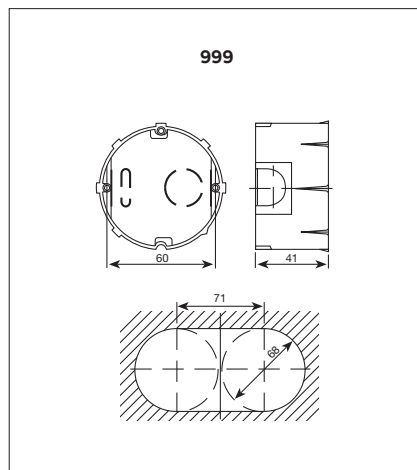
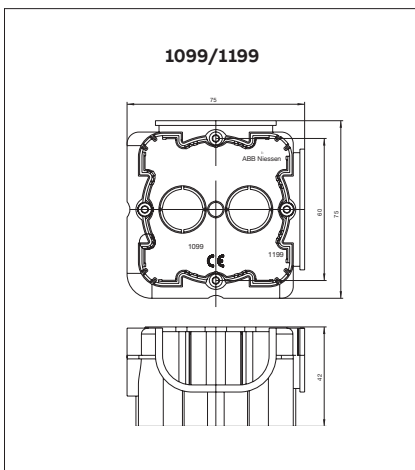



# Notes

A large rectangular area filled with a fine grid of dotted lines, intended for writing notes.

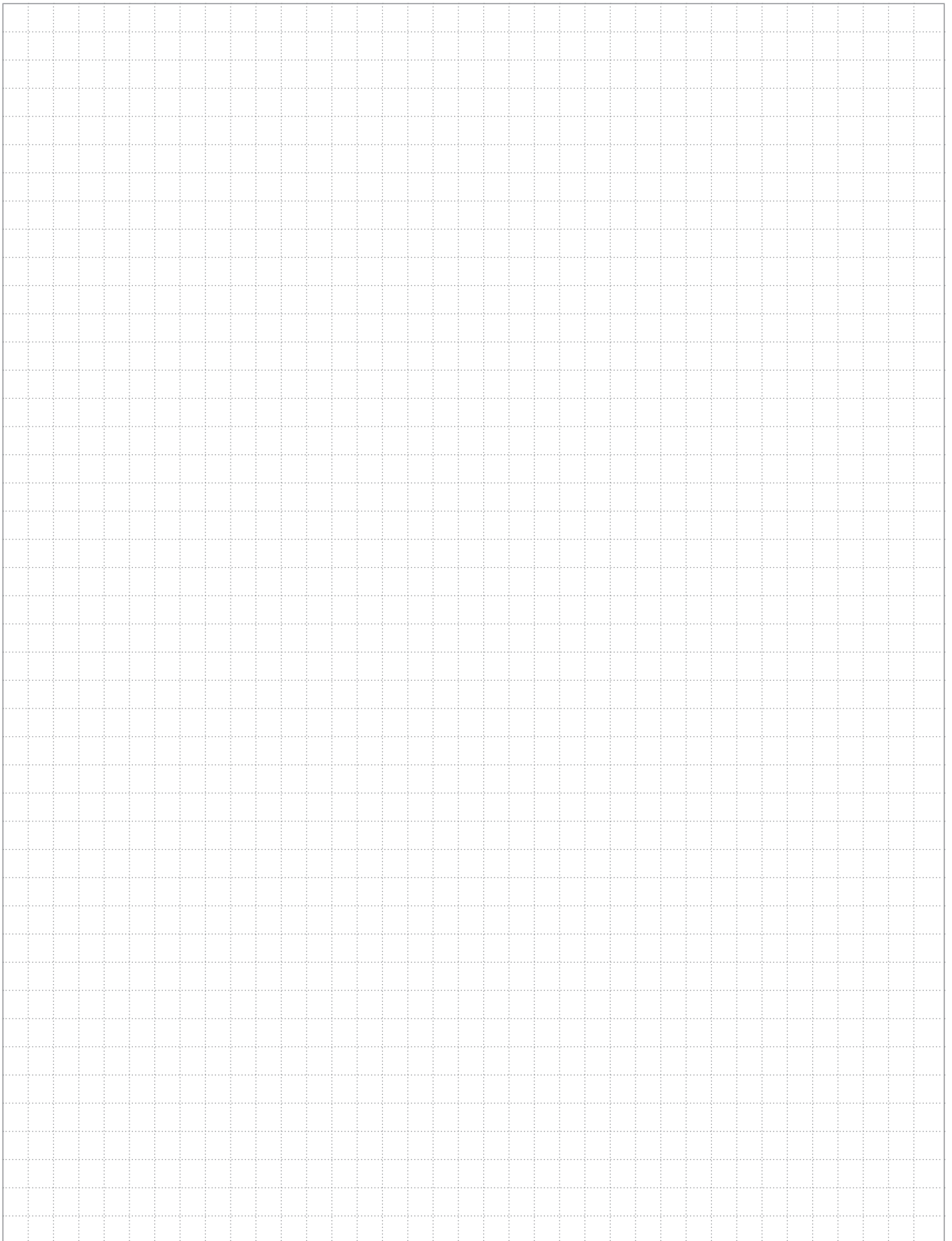



---

**Asea Brown Boveri, S.A.**  
**Low Voltage Products - Niessen**

Pol. Ind. de Aranguren, 6  
20180 OIARTZUN  
Spain  
Tel.: +34 943 260 101  
Fax: +34 943 260 240  
[www.abb.es/niessen](http://www.abb.es/niessen)

