

# Electrical installation solutions for buildings

## Legislation & requirements

### Index

Legislation & requirements	16/2
Checklist for emergency lighting system design	16/8
Spacing data	16/9
Euro pictogram format	16/16
ISO 7010 format	16/18

# Technical reference

## Legislation & requirements

### 01 Emergency lighting technical reference

The requirement for emergency lighting originates from the Fire Precautions Act 1971 and was further enforced by the Fire Precautions (Workplace) Regulations 1997 (Amended 1999).

The Regulatory Reform (Fire Safety) Order, FSO came into force in October 2006 and now replaces all previous fire safety legislation.

The key considerations from the Fire Safety Order are:

- The FSO creates one simple fire safety legislative control for all workplaces/non-domestic premises
- Control is fire risk assessment based, with the responsibility for fire safety resting with the 'responsible person' for the premises
- All persons inside the building/in the vicinity who might be affected by a fire must be protected
- Employees will be required to act upon the fire risk assessment, make remedial arrangements accordingly and maintain the fire precautions

- Failure to comply with the rules would be a breach of law, with the consequence of enforcement or prohibition notices being served

The fire safety risk assessment is a legal requirement, and where a site has 5 or more employees the risk assessment must be documented.

Fire certificates under the Fire Precautions Act 1971 are now no longer valid. Guidance documents on the new Fire Safety legislation have been published and the appropriate ones must be consulted as part of the overall fire risk assessment.

Other important legislation and regulations, such as The Buildings Regulations and The Health and Safety "Safety Signs and Signals" Regulations 1996, also have a requirement for emergency lighting and must be considered as part of the design and specification.



02 Figure A.  
Exit sign boards have a maximum viewing distance defined as 100 x the height of the sign (h), in metres

03 Figure B.  
For illuminated exit signs, the maximum viewing distance is defined as 200 x the height of the sign (h), in metres

The Regulatory Reform (Fire Safety) Order, FSO came into force in October 2006 and has replaced all previous fire safety legislation.

The requirement for emergency lighting originates from the Fire Precautions Act 1971 and was further enforced by the Fire Precautions (Workplace) Regulations 1997 (Amended 1999).

The key considerations from the Fire Safety Order are:

- The FSO creates one simple fire safety legislative control for all workplaces/non-domestic premises
- Control is fire risk assessment based, with the responsibility for fire safety resting with the 'responsible person' for the premises
- All persons inside the building/in the vicinity who might be affected by a fire must be protected
- Employees will be required to act upon the fire risk assessment, make remedial arrangements accordingly and maintain the fire precautions
- Failure to comply with the rules would be a breach of law, with the consequence of enforcement or prohibition notices being served

The fire safety risk assessment is a legal requirement, and where a site has 5 or more employees the risk assessment must be documented.

Fire certificates under the Fire Precautions Act 1971 are now no longer valid. Guidance documents on the new Fire Safety legislation have been published and the appropriate ones must be consulted as part of the overall fire risk assessment.

Other important legislation and regulations, such as The Buildings Regulations and The Health and Safety "Safety Signs and Signals" Regulations 1996, also have a requirement for emergency lighting and must be considered as part of the design and specification. A number of standards have been devised to provide guidance on application of emergency lighting in line with legislative requirements, and to determine the quality of product to be specified.

The major standards to be considered when designing a high-level emergency lighting system are:

- **BS 5266-1, BS EN 1838:2013, BS 5266-8**  
These sections of the standards set the guidelines for installation of emergency lighting, where to locate emergency luminaires and exit signs and the minimum lighting levels required. Note that BS 5266-7 has been superseded by BS EN 1838:2013.
- **BS EN 60598.2.22**  
This is the product standard which establishes the performance requirements of emergency lighting luminaires and internally illuminated exit signs

#### • IEC 62034

This standard defines the requirement for automated testing systems for emergency lighting

#### • Lighting Industry Association & ICEL

Guides and registration schemes provided by the Industry Committee for Emergency Lighting which define enhanced performance requirements for the differing types of emergency lighting, backed by independent testing

#### Exit signs

Designated legend formats  
European pictogram format SI341 signs are acceptable, as are ISO 7010 format signs, although there should not be a mixture of both within an installation.



ISO 7010



EU-format, SI-341

Text only signs are no longer acceptable and should have been withdrawn.



SI-341: UK legislation,  
Statutory Instrument 341

#### Maximum viewing distances

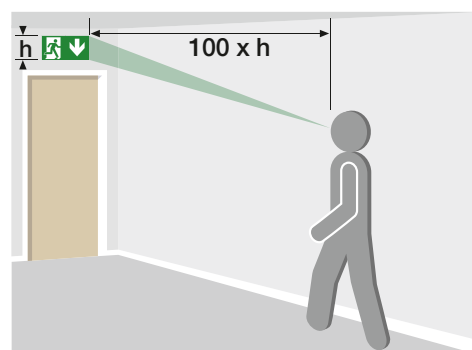

02

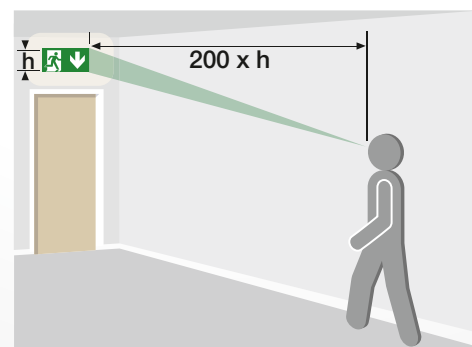

03



# Technical reference

## Legislation & requirements

- 01 Near an exit door
- 02 New stairs and changes of level
- 03 Near each piece of fire-fighting equipment or manual call point
- 04 Near changes in direction
- 05 Near each piece of fire-fighting equipment or manual call point
- 06 Near each First Aid point

### General requirements for emergency lighting (BS 5266-1, BS EN 1838:2013, BS 5266-8)

If emergency lighting is required it should:

- Indicate the escape routes clearly with exit signs so there is no doubt which is the way out
- Ensure fire safety equipment such as fire alarm call-points, fire extinguishers etc can be located
- Illuminate escape routes, and open areas used in escape routes so that obstacles can be avoided
- Provide illumination for high risk task areas to allow the processes to be shut down safely

Any point on an escape route or leading to it must have an exit sign so that direction of travel is never in doubt. Internally illuminated exit signs offer the most effective method of achieving the requirement, and have a viewing distance twice that of exit signboards - see below.

Note: where exit sign boards are installed, these must now have 5 lux illuminance on the sign to meet the requirements on BS 5266 / EN 1838 - for practical purposes unachievable through use of converted mains luminaires.

### Points of emphasis

An escape route luminaire shall be positioned to give emphasis on potential danger points, as well as for safety and fire equipment.

- Near all emergency exit doors
- At changes of direction along the escape route, to illuminate in both directions
- At intersection of corridors, to illuminate in both directions
- At changes in level to avoid tripping
- Near stairs, so stair flights are directly lit
- Near each piece of firefighting equipment or manual call point, to a level of 5 lux in the vertical.
- Near first aid points, to a level of 5 lux in the vertical
- At externally illuminated exit signs and other safety signs, which identify a hazard
- Near escape route equipment in place for disabled people
- Near refuges and two-way telephone positions for the disabled
- Near 'disabled toilet' alarm call positions
- Near to each final exit on the inside
- Near to the final exit externally, to a place of safety
- Near is defined as 'within 2 m' in the horizontal.

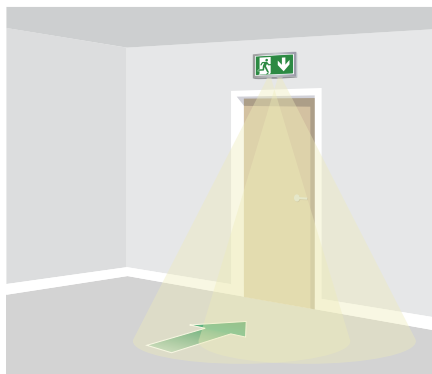

01

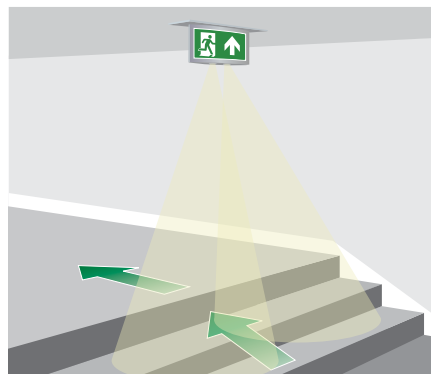

02

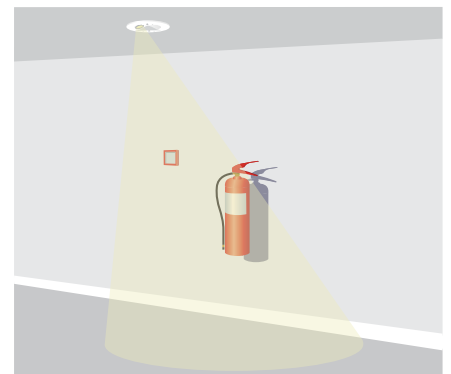

03

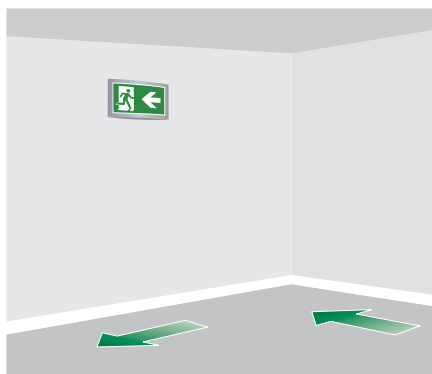

04

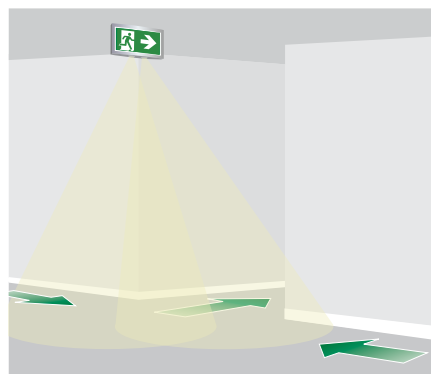

05

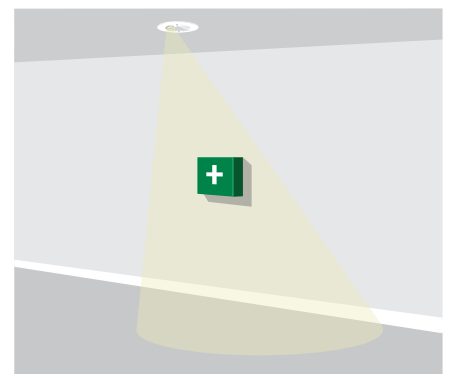

06

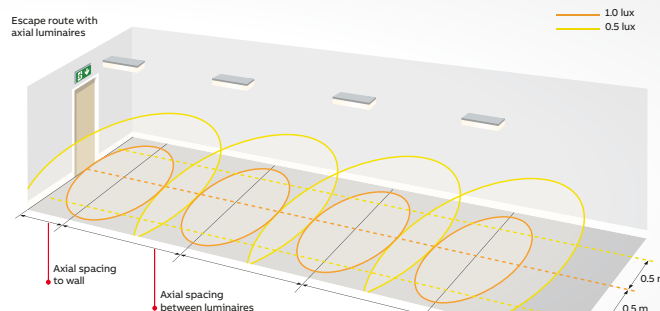
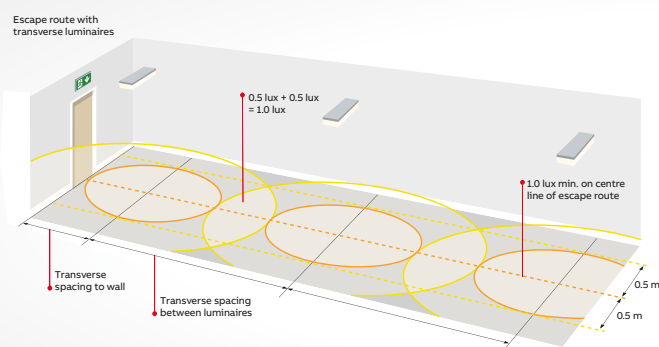

07

07 Escape routes with transverse and axial luminaires

08 Core areas

In addition to these points of emphasis, the following need to be considered when planning emergency lighting.

#### Escape routes

A defined escape route of 2 m width must be illuminated to a minimum of 1 lux along the centre line (see below).

#### Open areas (anti panic)

Open areas must be illuminated to 0.5 lux minimum in the core area (see below right). This also applies to areas with undefined escape routes, in halls or areas greater than 60 m<sup>2</sup>.

#### High risk task areas

This refers to areas normally associated with moving machinery, dangerous materials or processes, and other areas of high risk where hazards may continue after mains lighting failure.

Illuminance levels should be maintained at 10% (or over) of the normal lighting level or 15 lux, provided within 0.5 seconds, to allow for safe egress and/or termination of processes. For high risk task areas, the lux requirement is calculated at the plane of the task rather than floor level.

#### Additional areas

Additional areas not part of the escape route still require illumination as people may be located there and/or measures may be required to ensure the safety of persons or processes. These areas include kitchens, first aid/operating rooms, lifts, refuge areas, escalators and moving walkways, toilets larger than 8 m<sup>2</sup> (or smaller without borrowed light), disabled toilets, small lobbies and pedestrian routes within covered car parks.

#### System integrity

All compartments should include two or more emergency luminaires to counter the risk of emergency luminaire failure.

#### Luminaire mounting height

Emergency luminaires should be mounted at least 2 m above the floor. There is no upper limit but luminaires should be fitted below smoke level if there is a significant risk of floor illumination being affected.

#### Stand-by lighting

If stand-by lighting is used as emergency lighting it should conform to all the requirements of emergency lighting.

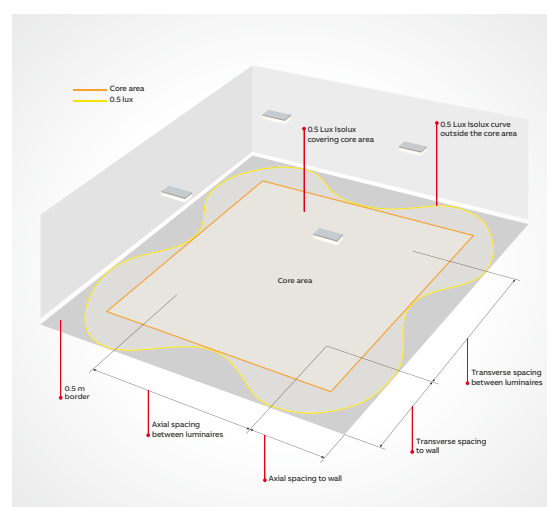

08

# Technical reference

## Legislation & requirements

### Specific location requirements

BS 5266 stipulates light levels, response and duration times for specific locations within premises, and for specific activities, including:

- Kitchens
- First aid rooms
- Examination and treatment rooms
- Refuge areas for the mobility impaired
- Plant rooms, switch rooms and emergency winding facilities for lifts
- Reception areas
- Crash bars or security devices at exit doors
- Inspection of the condition of fire control and indicating equipment

A table showing the illuminance recommendation for these specific locations and requirements can be found in BS 5266-1.

### Emergency lighting systems

There is a varied range of emergency lighting available to suit different budgets, decors, building requirements, colours and specifications. The types and categories available for specification are:

#### Types of emergency lighting

##### • Self-contained

Each luminaire contains a battery and electronic circuitry to charge batteries and operate the lamp

##### • Slave

Luminaires are powered from a central system

##### • Conversions

Almost any mains fluorescent luminaire can be converted for emergency use. Emergi-Lite is registered to ICEL to undertake emergency lighting conversions at our head office facility in Leeds, UK

#### Categories of emergency lighting

##### • Non-maintained (NM)

Luminaires operate when the mains fail

##### • Maintained (M)

Luminaires operate when the mains fail, but can also be operated if required using

a switch when the mains supply is healthy

##### • Combined Non-maintained (CNM)

The luminaire contains more than one lamp, one of which is mains operated, the other is for emergency use only. When the mains is healthy one or more lamps operate, but should the mains fail the emergency lamp operates

##### • Combined Maintained

Similar to combined non-maintained, but when the mains supply is healthy both lamps operate, whereas on mains failure only one lamp operates

CE marking alone on an emergency lamp does not necessarily imply that the product will work in an emergency situation. All emergency lighting must be designed and manufactured to meet the requirements of BS EN 60598.2.22, the established product standard.

Emergency lighting products may be independently certified and approved as a means of proving quality in the product, thereby giving an enhanced level of assurance to the installer, and greater confidence and less risk in the work he performs. Emergency lighting independently tested and carrying the approval of a recognised national standards body, such as the BSI Kitemark or European ENEC mark, serves this purpose.

#### Testing and maintenance of emergency lighting

Fire legislation requires the safety systems within a building to be tested and maintained to ensure correct working order.

The major standards for emergency lighting establish the testing requirement, and that testing and maintenance should be done by a "competent person" (trained, with appropriate skills and experience).

Automated testing solutions are available to assist with the testing requirement, such as the Self-Test, IR2 infra-red and Naveo®Pro addressable testing solutions available from Emergi-Lite (see pages 72-77 of this catalogue for



more details on these solutions).

For automated testing solutions, IEC 62034 provides specific guidance for luminaire testing, including:

- Testing should be undertaken during periods of low risk
  - Tests should be performed at the appropriate times for the correct duration
  - Testing should prove the emergency circuit operates correctly, and that the battery powers the luminaire for the duration of the test
- Results of the test should be reliably indicated

Within the IEC 62034 Standard, test systems for both self-contained and centrally powered emergency lighting systems are covered.

# Technical reference

## Checklist for emergency lighting system design

### Checklist for emergency lighting system design

Point	Establish	Action
1	Establish position of fire equipment, position of hazards such as steps, each of changes of direction, stairs, first aid points etc.	Provide an emergency luminaire near (within 2 m horizontally) of these points of emphasis.
2	Establish designated exit doors, points on escape routes or where a sign is required to make the exit obvious.	Provide exit signs with arrows if necessary, observing the maximum viewing distances of the exit sign type.
3	Establish the need for external escape lighting.	Provide emergency luminaires so that people can proceed outside to a place of safety.
4	Establish the escape routes and establish mounting heights of luminaires and exit signs.	Position luminaires along parts of the escape route not already illuminated near the above points to provide 1 lux minimum along the centre line and 0.5 lux minimum in the 1 m central band. Use published data in the form of spacing tables for the luminaires to determine the positions taking into account the mounting height.
5	Establish the open areas used as escape routes and other open areas larger than 60 m <sup>2</sup> and establish mounting heights of luminaires above the floor.	Provide 0.5 lux minimum in the core area. Use published data (as above) to determine the positions.
6	Establish the position of lifts, escalators, toilets, control/plant rooms, pedestrian walkways in covered car parks.	Provide emergency luminaires in all of these areas.
7	Establish the location of any first aid point or fire equipment not on an escape route or open area.	Provide 5 lux emergency illuminance on the floor in the vicinity of the point. This also applies for a first aid room.
8	Establish the toilet areas.	Provide emergency lighting for toilets larger than 8 m <sup>2</sup> , as if they were open areas. For toilets smaller than 8 m <sup>2</sup> , unless illuminated by borrowed emergency light from another area, provide at least one emergency luminaire. Provide emergency lighting to all disabled toilets.
9	Establish any small lobbies with no borrowed light.	Provide emergency lighting.
10	Establish any central power supply (if used) is in an area of low risk away from other switchgear or plant.	Position the central power supply in its own room in fire-proof construction.
<b>If the building use is known:</b>		
11	Establish any need for stand-by lighting.	Provide generators as required. If the response time is longer than 5 seconds, then transitional, alternative or additional emergency lighting must be provided.
12	Establish any special needs for the occupants such as impaired mobility or impaired sight.	Provide additional emergency lighting to reduce the risk to those people to help them evacuate the premises. This applies to designated refuge areas (which may require the provision of emergency voice communication).
13	Establish the location of any high risk task areas and the normal lighting illuminance (lux) in these areas.	Provide 10% of the normal illuminance (lux) or 15 lux minimum.
14	Establish if there are any dust or dirt problems.	Allow a service factor as appropriate. 0.8 is allowed for normal areas, but for dusty environments 0.5 may be required, or alternatively instigate a regular cleaning procedure.
15	Establish any local regulations.	Provide emergency lighting to comply with the regulations.
16	Establish if there is any dimmable lighting and shopping malls.	Provide maintained emergency lighting.
17	Establish whether people would be "unfamiliar" with the escape routes.	Provide maintained exit signs.
18	Establish the use of the premises: <ul style="list-style-type: none"> <li>• entertainment (including temporary such as licensed evening dance at a school)</li> <li>• sleeping risk</li> <li>• residential special care</li> <li>• non-residential care</li> <li>• public access non-residential</li> <li>• industrial</li> <li>• multi-storey dwelling over 10 storeys</li> </ul> Note : because the duration times are varied, it is customary in the UK to use	Recommended Minimum Duration: <ul style="list-style-type: none"> <li>3 hr</li> <li>3 hr</li> <li>3 hr</li> <li>1 hr</li> <li>1 hr</li> <li>1 hr</li> <li>3 hr</li> <li>3 hr</li> </ul>

Note: for points 5 and 6 the luminaires positioned near points of emphasis can be moved slightly within the 2 m horizontal tolerance to fit in with the spacing or array of emergency luminaires in the escape route or open area. This checklist is for guidance purposes only and does not form an exhaustive list of all requirements to standards and legislation, which should be reviewed when undertaking emergency lighting system design. '60Hz' option available on request, please contact Emergi-Lite . Please refer to ICEL (Industry Committee for Emergency Lighting) for updates and/or additional information [www.ICEL.co.uk]



# Technical reference

## Spacing data

In the UK, Building Regulation 2000 : B1 covers the provision of safe and effective means of escape from a building.

**Approved Document B (2000) (ADB) is a published guide to the Building Regulations, which specifies that standards for the installation of escape lighting should be according to BS 5266 Part 1.**

BS 5266 Part 1 is the umbrella standard which refers to EN 1838 (BS 5266 Part 7), defining emergency lighting levels of minimum 1.0 lux on the centre line of an escape route, and 0.5 lux minimum for open areas larger than 60m<sup>2</sup>.

British Standards are recognised worldwide, or are commonly used as the basis of local standards. NFPA 101 Life Safety Code standards require an average of 10.8 lux with not less than 1.1 lux at any point for escape routes.

We recommend that a copy of relevant local standards are obtained prior to any design work. We are pleased to supply data for any of our luminaires in LUMDAT format, for use with Relux or similar lighting packages.

We offer the following data for guidance to assist with design work to BS 5266 requirements. Data is shown for a selection of luminaires, for a typical 2.5 metre ceiling height.

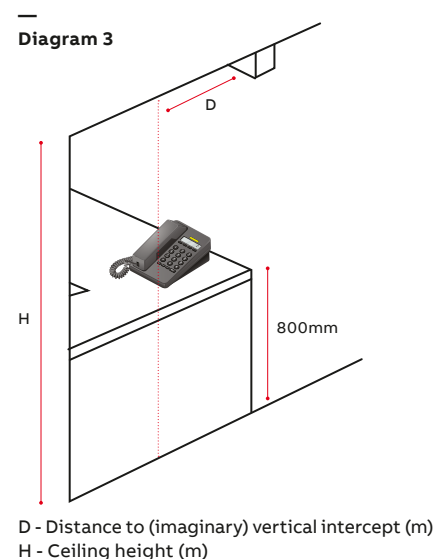
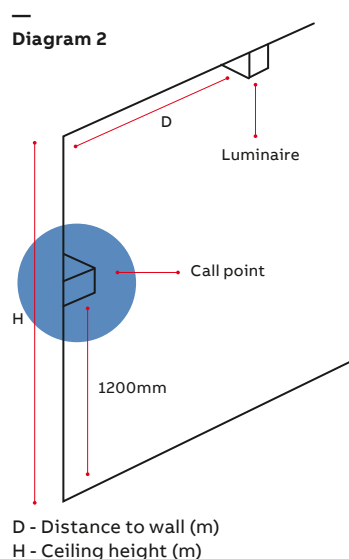
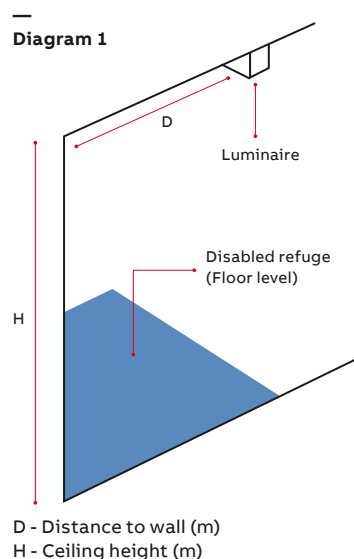

# Technical reference

## Spacing data

### Serenga SR2, emergency spot light

#### Point of emphasis - Disabled refuge see diagram 1

h (m)		Minimum lux
<b>Self-contained</b>		
2.5	1.6	7.2
2.8	1.8	7.2
3.2	1.9	6.3
3.7	2.1	5.5
4.0	2.3	5.05
<b>Slave 230V</b>		
2.5	1.5	8.2
2.8	1.7	7.1
3.2	2	6.6
3.7	2.3	5.9
4.0	2.4	5.7

### Serenga SR2, emergency spot light

#### Point of emphasis - Call point see diagram 2

h (m)		Minimum lux
<b>Self-contained</b>		
2.5	1.5	15.5
2.8	1.7	12.7
3.2	1.9	8.15
3.7	2.1	5.56
4.0	-	-
<b>Slave 230V</b>		
2.5	1.5	17.8
2.8	1.75	13.3
3.2	2	9.5
3.7	2.4	6.64
4.0	2.4	5.7





### Serenga SR2, emergency spot light

#### Point of emphasis - Telephone see diagram 3

h (m)		Minimum lux
<b>Self-contained</b>		
2.5	1	24.6
2.8	1.1	20.4
3.2	1.2	14.1
3.7	1.5	9.7
4.0	1.9	7.58
<b>Slave 230V</b>		
2.5	1	28.3
2.8	1.15	21.4
3.2	1.4	15.2
3.7	1.5	11.2
4.0	1.75	9.06

### Serenga SR2, wall mount Lens G

#### Self contained and Slave (1.0 lux) Slave (1.0 lux)

h (m)					
<b>Distance to escape route centre (t)</b>					
	<b>1m</b>		<b>1.5m</b>		
0.5	1.5	3.7	1.7	5.0	
1.0	1.6	4.0	1.6	5.7	
1.5	1.5	3.6	2.5	5.8	
2.0	1.2	3.5	2.5	5.6	
2.5	0.0	1.8	2.3	5.3	
3.0	0.0	0.0	2.0	5.0	
3.5	0.0	0.0	1.1	3.3	

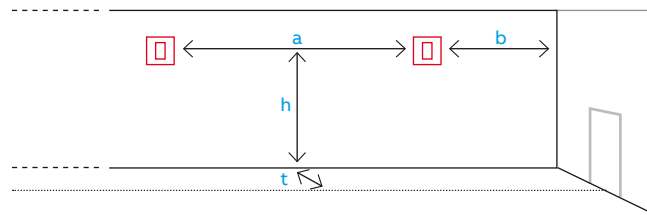

# Technical reference

## Spacing data

Serenga 2, escape route lighting - lens A

h (m)				
<b>Self Contained (1.0 lux)</b>				
2.0	1.8	4.9	6.4	18.8
2.5	1.3	5.3	6.4	19.4
3.0	1.0	5.0	3.9	18.3
3.5	0.9	3.9	3.6	16.6
4.0	0.9	3.1	2.5	15.6
<b>Slave (1.0 lux)</b>				
2.0	2.0	5.2	7.0	19.7
2.5	1.6	5.6	6.9	20.8
3.0	1.2	5.5	4.8	20.0
3.5	1.1	4.8	4.0	19.7
4.0	1.0	3.7	3.2	16.8

Serenga 2, escape route lighting - lens B

h (m)				
<b>Self Contained (1.0 lux)</b>				
4.5	1.6	4.2	6.9	17.4
5.0	1.6	4.4	7.1	18.3
5.5	1.6	4.5	7.3	19.1
6.0	1.6	4.6	7.1	19.8
6.5	1.5	4.7	7.2	20.3
7.0	1.4	4.7	7.0	20.5
7.5	1.3	4.7	7.0	20.7
8.0	1.1	4.6	6.7	20.7
<b>Slave (1.0 lux)</b>				
4.5	1.7	4.4	7.4	17.8
5.0	1.7	4.6	7.7	19.0
5.5	1.8	4.7	7.8	19.9
6.0	1.7	4.9	7.6	20.7
6.5	1.6	5.0	7.7	21.3
7.0	1.6	5.0	7.7	21.8
7.5	1.5	5.0	7.5	22.0
8.0	1.4	5.0	7.4	22.1

Serenga 2, escape route lighting - lens C

h (m)				
<b>Self Contained (1.0 lux)</b>				
8.5	2.0	5.8	7.1	17.0
9.0	1.9	5.8	7.3	17.7
9.5	1.7	5.9	7.4	18.3
10.0	1.2	5.9	7.5	18.9
10.5	0.0	6.0	0.0	14.1
11.0	0.0	5.2	0.0	12.6
11.5	0.0	4.5	0.0	12.2
12.0	0.0	4.0	0.0	12.0
<b>Slave (1.0 lux)</b>				
8.5	2.1	6.1	7.6	17.4
9.0	2.1	6.2	7.8	18.1
9.5	2.0	6.2	7.9	18.8
10.0	1.9	6.2	8.1	19.4
10.5	1.5	6.3	7.9	20.0
11.0	0.4	6.4	8.0	20.6
11.5	0.0	6.4	0.0	14.0
12.0	0.0	5.2	0.0	13.3

Serenga 2, open area- lens D

h (m)				
<b>Self Contained (0.5 lux)</b>				
2.0	3.9	8.1	3.9	8.1
2.5	4.6	10.0	4.6	10.0
3.0	5.4	11.6	5.4	11.6
3.5	6.0	13.2	6.0	13.2
4.0	6.6	14.8	6.6	14.8
<b>Slave (0.5 lux)</b>				
2.0	3.9	8.2	3.9	8.2
2.5	4.6	10.0	4.6	10.0
3.0	5.4	11.8	5.4	11.8
3.5	6.3	13.4	6.3	13.4
4.0	6.9	15.0	6.9	15.0

Serenga 2, open area - lens E

h (m)				
<b>Self Contained (0.5 lux)</b>				
4.5	5.0	11.0	5.0	11.0
5.0	5.3	12.0	5.3	12.0
5.5	5.5	12.9	5.5	12.9
6.0	5.8	13.7	5.8	13.7
6.5	5.6	14.4	5.6	14.4
7.0	4.2	14.3	4.2	14.3
7.5	3.6	14.1	3.6	14.1
8.0	3.2	14.1	3.2	14.1
<b>Slave (0.5 lux)</b>				
4.5	5.0	11.2	5.0	11.2
5.0	5.3	12.2	5.3	12.2
5.5	5.7	13.1	5.7	13.1
6.0	6.0	14.0	6.0	14.0
6.5	6.0	14.7	6.0	14.7
7.0	8.8	15.5	8.8	15.5
7.5	4.5	15.3	4.5	15.3
8.0	4.1	15.2	4.1	15.2

Serenga 2, open area - lens F

h (m)				
<b>Self Contained (0.5 lux)</b>				
8.5	4.7	11.4	4.7	11.4
9.0	4.8	11.7	4.8	11.7
9.5	4.8	12.0	4.8	12.0
10.0	5.1	12.4	5.1	12.4
10.5	5.1	12.7	5.1	12.7
11.0	5.1	12.9	5.1	12.9
11.5	5.1	13.2	5.1	13.2
12.0	5.3	13.5	5.3	13.5
<b>Slave (0.5 lux)</b>				
8.5	4.9	11.8	4.9	11.8
9.0	5.0	12.1	5.0	12.1
9.5	5.0	12.5	5.0	12.5
10.0	5.3	12.8	5.3	12.8
10.5	5.3	13.1	5.3	13.1
11.0	5.4	13.5	5.4	13.5
11.5	5.6	13.7	5.6	13.7
12.0	5.6	14.0	5.6	14.0

# Technical reference

## Spacing data

### Daylite Prismatic LED 251 Lm

h (m)				
<b>Escape</b>				
2.0	3.5	7.3	1.6	5.5
2.5	4.2	8.8	1.5	4.6
3.0	5.0	10.3	1.1	4.6
4.0	-	13.4	-	3.6
<b>Open</b>				
2.0	3.7	7.6	2.7	6.9
2.5	4.4	9.3	2.3	7.5
3.0	5.2	10.9	2.3	7.8
4.0	6.7	13.8	1.8	6.6

### Daylite Opal LED 214 Lm

h (m)				
<b>Escape</b>				
2.0	3.1	7.8	2.8	7.0
2.5	3.3	8.4	2.9	7.6
3.0	3.3	8.9	3.0	8.0
4.0	3.2	9.4	2.8	8.3
<b>Open</b>				
2.0	3.9	9.6	3.5	8.7
2.5	4.2	10.5	3.8	9.5
3.0	4.4	11.3	4.0	10.2
4.0	4.7	12.4	4.2	11.1

### Daylite Silverscape Prismatic LED 241 Lm

h (m)				
<b>Escape</b>				
2.0	3.6	7.6	2.6	6.5
2.5	3.9	9.2	2.9	7.1
3.0	4.4	10.7	1.5	7.7
4.0	-	12.0	-	4.6
<b>Open</b>				
2.0	3.8	8.0	3.3	7.5
2.5	4.6	9.6	3.6	8.5
3.0	5.3	11.3	3.8	9.5
4.0	6.0	14.4	2.3	10.6

### Cordona Prismatic LED 207 Lm S/C EM

h (m)				
<b>Escape</b>				
2.0	2.9	7.3	2.9	7.3
2.5	3.1	7.9	3.1	7.9
3.0	3.1	8.3	3.1	8.3
4.0	3.1	8.8	3.1	8.8
<b>Open</b>				
2.0	3.7	9.1	3.7	9.1
2.5	3.9	9.9	3.9	9.9
3.0	4.2	10.6	4.2	10.6
4.0	4.4	11.6	4.4	11.6

### Cordona & Camarque Opal LED 1830 Lm Slave

h (m)				
<b>Escape</b>				
2.0	5.7	13.8	5.7	13.8
2.5	6.3	15.3	6.3	15.3
3.0	6.8	16.5	6.8	16.4
4.0	7.6	18.8	7.6	18.7
<b>Open</b>				
2.0	6.9	16.7	6.9	16.6
2.5	7.6	18.3	7.6	18.3
3.0	8.2	20.1	8.2	20.0
4.0	9.4	22.8	9.4	22.8

### Cordona Prismatic LED 2355 Lm Slave

h (m)				
<b>Escape</b>				
2.0	5.8	14.3	5.8	14.1
2.5	6.5	15.7	6.6	15.5
3.0	7.1	16.8	7.1	16.9
4.0	8.0	19.7	7.9	19.7
<b>Open</b>				
2.0	7.2	17.0	7.1	16.9
2.5	7.8	18.9	7.7	18.7
3.0	8.4	20.8	8.5	20.4
4.0	9.9	23.4	9.9	23.3

### Cordona & Camarque Opal LED 207 Lm S/C EM

h (m)				
<b>Escape</b>				
2.0	2.9	7.3	2.9	7.3
2.5	3.1	7.9	3.1	7.9
3.0	3.1	8.3	3.1	8.3
4.0	3.1	8.8	3.1	8.8
<b>Open</b>				
2.0	3.7	9.1	3.7	9.1
2.5	3.9	9.9	3.9	9.9
3.0	4.2	10.6	4.2	10.6
4.0	4.4	11.6	4.4	11.6

### Weather force opal LED 207 Lm

h (m)				
<b>Escape</b>				
2.0	2.9	7.5	2.7	6.9
2.5	3.0	8.0	2.9	7.5
3.0	3.0	8.3	2.9	7.8
4.0	2.8	8.6	2.7	8.2
<b>Open</b>				
2.0	3.7	9.4	3.5	8.7
2.5	4.0	10.2	3.8	9.4
3.0	4.2	10.8	3.9	10.0
4.0	4.3	11.6	4.1	10.9

# Technical reference

## Spacing data

### PrimEvo XT100E & XT100ST

h (m)	
2.00	2.49 6.57 6.92 7.19 2.57
2.50	2.50 6.93 7.17 7.34 2.56
3.00	2.39 7.11 7.28 7.40 2.43
3.50	2.14 7.12 7.22 7.32 2.17
4.00	1.68 6.96 6.99 7.07 1.72

### PrimEvo TW220E

h (m)	
2.50	5.39 11.75 6.85 2.03 0.86
3.00	6.47 14.11 8.22 2.44 1.04
3.50	7.15 16.04 9.26 2.66 1.18
4.00	7.57 17.69 9.89 2.87 1.28
4.50	7.94 19.15 10.44 3.14 1.36
5.00	7.93 20.15 10.87 3.39 1.42

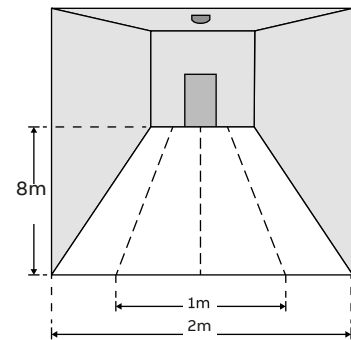

### PrimEvo RS100E/RS100ST and SM100E/SM100ST

h (m)	
2.00	1.34 3.41 6.14 9.41 4.10
2.50	1.40 3.69 6.87 10.66 4.44
3.00	1.50 3.81 7.44 11.53 4.69
3.50	1.55 3.91 7.85 12.28 4.90
4.00	1.53 4.10 8.15 12.86 5.17

### Indulux Double Sided LED IND3LS5DS & CTIND3LS5DS

h (m)	
<b>Self contained 1hr (MF 0.8 - 1.0 lux)</b>	
2.5	3.89 10.70 2.39 6.31
3.0	3.81 10.91 2.36 6.60
3.5	3.62 10.94 2.23 6.74
4.0	3.25 10.82 1.96 6.74
4.5	2.50 10.54 1.49 6.59
5.0	0.19 10.09 0.32 6.28
5.5	- 8.54 - 5.78
6.0	- 6.80 - 4.22
6.5	- 3.74 - 2.98
7.0	- 0.94 - 1.20

### Indulux Single Sided LED IND3LS5 & CTIND3LS5

h (m)	
<b>Self contained 1hr (MF 0.8 - 1.0 lux)</b>	
2.5	3.50 9.24 3.01 7.70
3.0	3.56 9.65 3.11 8.19
3.5	3.54 9.92 3.13 8.54
4.0	3.43 10.06 3.07 8.76
4.5	3.25 10.09 2.94 8.89
5.0	2.96 10.02 2.71 8.90
5.5	2.56 9.82 2.37 8.80
6.0	1.94 9.50 1.84 8.60
6.5	0.77 9.08 0.84 8.27
7.0	- 8.51 - 7.81

### Indulux Double sided LED IND1LS5DS & IND1LS5DSLTC

h (m)	
<b>Slave 1hr (MF 0.8 - 1.0 lux)</b>	
2.5	5.37 14.17 3.16 7.89
3.0	5.49 14.73 3.30 8.46
3.5	5.51 15.11 3.38 8.90
4.0	5.45 15.36 3.37 9.22
4.5	5.31 15.48 3.29 9.44
5.0	5.10 15.47 3.14 9.55
5.5	4.74 15.35 2.88 9.55
6.0	4.21 15.14 2.50 9.46
6.5	2.14 14.80 1.93 9.25

### Indulux Single sided LED IND1LS5 & IND1LSLTC

h (m)	
<b>Slave 1hr (MF 0.8 - 1.0 lux)</b>	
2.5	4.62 11.80 3.83 9.46
3.0	4.82 12.50 4.07 10.22
3.5	4.95 13.04 4.25 10.85
4.0	5.03 13.48 4.36 11.37
4.5	5.04 13.82 4.42 11.79
5.0	5.00 14.05 4.43 12.10
5.5	4.90 14.20 4.38 12.33
6.0	4.74 14.28 4.28 12.50

# Technical reference

## Spacing data

### Hyled, escape route lighting



h (m)	Self Contained (1.0 lux) 3hr			
2.0	1.8	5.3	3.7	8.2
2.5	1.7	5.2	4.5	8.9
3.0	1.7	5.0	5.2	11.3
3.5	1.8	4.9	5.9	12.9
4.0	2.0	4.9	6.5	14.4
5.0	2.3	5.3	8.2	17.3
6.0	2.5	5.9	9.4	20.2
7.0	2.6	6.5	10.6	23.0
8.0	2.7	7.0	11.7	25.8
9.0	2.7	7.5	12.7	28.3
10.0	2.5	7.8	13.6	30.7
11.0	1.7	8.0	14.0	33.0
h (m)	Slave (1.0 lux)			
2.0	1.9	5.4	3.9	8.2
2.5	2.4	6.8	4.9	10.4
3.0	2.8	8.3	5.7	12.5
3.5	2.8	8.3	6.4	14.2
4.0	2.7	8.2	7.0	15.8
5.0	2.7	7.8	8.5	18.8
6.0	3.0	7.8	9.8	22.0
7.0	3.4	7.9	11.5	24.9
8.0	3.5	8.5	12.6	27.7
9.0	3.8	9.1	14.2	30.6
10.0	4.0	9.7	15.2	33.6
11.0	4.2	10.3	16.8	36.4
12.0	4.3	10.8	17.6	39.2
13.0	4.4	11.3	19.1	41.8
14.0	4.2	11.8	19.9	44.4
15.0	4.0	12.1	20.5	46.8
16.0	3.7	12.4	21.1	49.2
17.0	3.0	12.6	21.6	51.5
18.0	1.6	12.5	21.3	53.7

### Hyled, open area



h (m)	Self Contained (0.5 lux) 3hr			
2.0	3.4	7.6	3.4	9.6
2.5	4.2	9.1	4.2	9.1
3.0	4.8	10.7	4.8	10.7
3.5	5.2	12.0	5.2	12.0
4.0	5.6	13.3	5.6	13.3
5.0	6.3	15.3	6.3	15.3
6.0	6.8	16.8	6.8	16.8
7.0	7.1	18.1	7.1	18.1
8.0	7.4	19.2	7.4	19.2
9.0	7.5	20.1	7.5	20.1
10.0	7.2	20.9	7.2	20.9
11.0	6.3	21.5	6.3	21.5
h (m)	Slave (0.5 lux)			
2.0	3.6	7.7	3.6	7.7
2.5	4.5	9.7	4.5	9.7
3.0	5.2	11.7	5.2	11.7
3.5	6.1	13.3	6.1	13.3
4.0	6.8	14.5	6.8	14.8
5.0	7.8	17.7	7.8	17.7
6.0	8.7	20.4	8.7	20.4
7.0	9.5	22.5	9.5	22.5
8.0	10.1	24.4	10.1	24.4
9.0	10.6	25.9	10.6	25.9
10.0	11.0	27.3	11.0	27.3
11.0	11.3	28.5	11.3	28.5
12.0	11.9	29.7	11.9	29.7
13.0	12.0	30.7	12.0	30.7
14.0	12.1	31.7	12.1	31.7
15.0	11.6	32.6	11.6	32.6
16.0	11.1	33.2	11.1	33.2
17.0	10.6	33.8	10.6	33.8
18.0	7.6	34.2	7.6	34.2

### Ovano, XT200M3H & XT201M3H



h (m)	XT200M3H			
2.0	3.11	7.53	3.29	7.50
2.5	3.35	8.34	3.49	8.37
3.0	3.48	8.98	3.62	8.93
3.5	3.51	9.47	3.68	9.37
4.0	3.47	9.79	3.65	9.70
h (m)	XT201M3H			
2.0	3.24	7.98	2.05	5.04
2.5	3.56	8.71	2.34	5.38
3.0	3.77	9.35	2.60	5.87
3.5	3.90	9.98	2.80	6.48
4.0	3.99	10.43	2.94	7.02

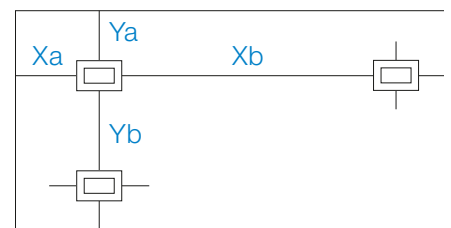

# Technical reference

## Spacing data

Lutia ceiling mount Open area



h (m)	Ya	Yb	Xa	Xb
<b>Self Contained 3 hrs (0.5 lux)</b>				
2.0	1.50	3.40	3.00	6.40
2.5	1.40	3.60	4.00	8.00
3.0	1.60	4.00	4.10	10.00
3.5	1.60	4.40	5.00	11.00
4.0	1.50	4.40	5.50	12.00
5.0	1.50	4.40	6.00	15.00
6.0	1.50	4.40	6.50	16.00
<b>Slave (0.5 lux)</b>				
2.0	1.70	4.00	3.00	7.00
2.5	2.00	4.60	3.50	8.00
3.0	2.00	5.00	5.00	10.00
3.5	2.20	5.20	5.00	10.00
4.0	2.30	5.40	6.00	13.00
5.0	2.30	6.20	7.50	15.00
6.0	2.20	6.20	8.00	18.00
7.0	2.20	6.60	8.00	18.00

Lutia ceiling mount escape route



h (m)	Ya	Yb	Xa	Xb
<b>Self Contained 3 hrs (1.0 lux)</b>				
2.0	1.1	3.2	3.8	8.5
2.5	1.0	3.0	4.5	9.9
3.0	1.0	3.0	5.0	11.3
3.5	1.1	2.9	5.5	12.6
4.0	1.1	2.9	5.8	13.8
5.0	1.0	3.0	5.7	15.6
6.0	0.7	3.0	5.2	16.3
<b>Slave (1.0 lux)</b>				
2.0	1.7	4.5	4.3	9.7
2.5	1.6	4.7	5.0	11.2
3.0	1.6	4.3	5.7	12.6
3.5	1.5	4.4	6.3	14.1
4.0	1.5	4.4	7.0	15.4
5.0	1.5	4.2	7.9	18.1
6.0	1.5	4.3	8.4	20.4
7.0	1.4	4.4	8.3	22.3

MirEvo Twinspot, escape route lighting

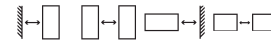

h (m)	Ya	Yb	Xa	Xb
<b>Self Contained 3 hrs (1.0 lux)</b>				
2.0	2.98	6.71	3.23	7.29
2.5	3.56	8.08	3.78	8.58
3.0	4.06	9.02	4.01	9.29
3.5	4.51	9.90	4.19	9.87
4.0	4.90	10.90	4.35	10.38
<b>Slave (1.0 lux)</b>				
2.0	3.02	6.75	3.26	7.34
2.5	3.69	8.28	3.94	8.91
3.0	4.16	9.25	4.19	9.62
3.5	4.63	10.08	4.40	10.22
4.0	5.05	11.03	4.57	10.75

Lutia wall mount Open area



h (m)	Yb	Xa	Xb
<b>Self Contained 3 hrs (0.5 lux)</b>			
2.0	1.70	2.50	6.00
2.5	1.70	3.50	8.00
3.0	2.00	4.00	9.00
3.5	2.10	5.30	10.00
4.0	2.10	6.00	14.00
5.0	2.40	6.70	15.00
<b>Slave (0.5 lux)</b>			
2.0	1.90	3.00	7.00
2.5	2.20	4.00	10.00
3.0	2.40	5.00	10.00
3.5	2.60	5.00	10.00
4.0	2.70	6.50	14.00
5.0	2.90	8.00	16.00
6.0	3.10	9.00	18.00
7.0	3.30	9.00	18.00

Lutia wall mount escape route

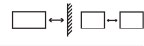

h (m)	Xa	Xb
<b>Self Contained 3 hrs (1.0 lux) Yc = 1m</b>		
2.0	3.50	7.80
2.5	4.10	9.40
3.0	4.60	10.00
3.5	5.00	12.00
4.0	5.20	12.80
5.0	5.30	14.20
6.0	4.60	14.40
<b>Slave (1.0 lux)</b>		
2.0	4.0	8.8
2.5	4.7	10.4
3.0	5.4	12.0
3.5	5.9	13.4
4.0	6.5	14.6
5.0	7.2	17.0
6.0	7.4	19.0
7.0	7.4	20.4

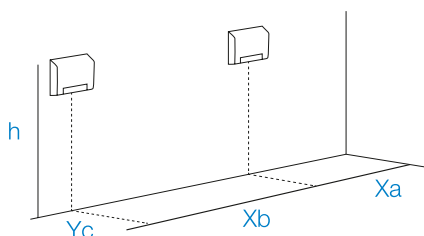
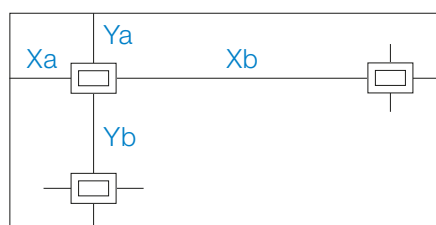

# Legends guide

## Euro pictogram format

### Single sided & safety equipment signs

Model	Serenga SER		Horizon OH		Aqualux OW / STF	
	Screen printed (curved)	Screen printed (normal)	Screen printed	Perspex screen printed	Screen printed (back-lit)	Self-adhesive (edge-lit)
	-	-	-	-	-	-
	SER-SC012	SER-SN012	XE02H	XE20HS	XE02W	RSE2W
	SER-SC010	SER-SN010	XE03H	XE30HS	XE03W	RSE3W
	SER-SC011	SER-SN011	XE06H	XE60HS	XE06W	RSE6W
	SER-SC013	SER-SN013	XE05H	XE50HS	XE05W	RSE5W
	SER-SC802	SER-SN802	XLF-SN802	XLF802HS	XLF802W	-
	SER-SC803	SER-SN803	XLF-SN803	XLF803HS	XLF803W	-

Model	Navigator Compact VE / DVE
	Screen printed
	XE02V31
	XE03V31
	XE06V31
	XE05V31

Model	Silver-Scape RB	Weatherforce DV	Weatherforce B / WA	Day-Lite Ex-cel XXW	Guideway 22	Guideway 32m
Format	Screen printed	Double sided fitted	Self-adhesive sticker	Self-adhesive sticker	Screen printed	Screen printed
	-	-	RSE120	RSE23560X	-	-
	XE02A31	-	RSE2120	RSE2X	XE02EG22	XE02EG32
	XE03A31	-	RSE3120	RSE3X	XE03EG22	XE03EG32
	XE06A31	-	RSE6120	RSE6X	XE06EG22	XE06EG32
	XE05A31	-	RSE5120	RSE5X	XE05EG22	XE05EG32

The standard 'Signs Directive' format is shown above. Other legend formats with different arrow directions, HTM65 format (below), BS 5499 mixed 'image/word' and foreign language variants are available by special request.









# Legends guide

## Euro pictogram format

### Double sided signs







Model	Horizon OH
Format	Panel screen printed
	-
	XE36HD
	XE55HD







Model	Silver-Scape RB	Weatherforce DV
Format	Screen printed	Double sided fitted
	XE02/2A32	(Suffix) XE22
	XE03/6A32	(Suffix) XE36
	XE05/5A32	(Suffix) XE55







# Legends Guide

## ISO 7010 format

### Single sided

Model	Serenga SER		Horizon OH		Aqualux OW / STF	
Format	Screen printed (curved)	Screen printed (normal)	Screen printed	Panel screen printed	Screen printed (back-lit)	Self-adhesive (edge-lit)
	-	-	-	-	-	-
	SER-SCN12	SER-SNN12	XEN2H	XEN20HS	XEN2W	RSEN2W
	SER-SCN10	SER-SNN10	XEN3H	XEN30HS	XEN3W	RSEN3W
	SER-SCN11	SER-SNN11	XEN6H	XEN60HS	XEN6W	RSEN6W
	SER-SCN13	SER-SNN13	XEN5H	XEN50HS	XEN5W	RSEN5W
<b>Arabic legend format</b>						
	SER-SCB01	SER-SNB01	XB01H	XB01HS	On request	XB01HS





Model	Navigator Compact VE / DVE		Silver-Scape RB	
Format			Screen printed	Screen printed
			-	-
			XEN2V31	XEN2A31
			XEN3V31	XEN3A31
			XEN6V31	XEN6A31
			XEN5V31	XEN5A31
<b>Arabic legend format</b>				
			XB01V31	XB01A31

Model	Weatherforce DV	Weatherforce B /WA	Day-Lite Ex-cel XXW	Guideway 22m	Guideway 32
Format	Double sided fitted	Self-adhesive sticker	Self-adhesive sticker	Screen printed	Screen printed
	-	-	RSEN23560X	-	-
	-	RSEN2120	RSEN2X	XEN2EG22	XEN2EG32
	-	RSEN3120	RSEN3X	XEN3EG22	XEN3EG32
	-	RSEN6120	RSEN6X	XEN6EG22	XEN6EG32
	-	RSEN5120	RSEN5X	XEN5EG22	XEN5EG32
<b>Arabic legend format</b>					
	XB10DV32	RSB1X	RSB1X	XBN1EG22	XBN1EG32



# Legends guide

## ISO 7010 format

### Single sided (Flag mounted)

Model	Guideway 22m
Format	Screen printed
	XEN602EG22
	XEN603EG22
	XEN606EG22
	XEN605EG22

### Double sided signs

Model	Silver-Scape RB	Weatherforce DV
Format	Screen printed	Double sided fitted
	XEN2/2A32	XEN2/2DV32
	XEN3/6A32	XEN3/6DV32
	XEN5/5A32	XEN5/5DV32

