



Ventiladores helicoidales tubulares con camisa con tratamiento anticorrosión por cataforésis y pintura poliéster, hélice de aluminio equilibrada dinámicamente, motor monofásico (TCBB) o trifásico (TCBT), IP65 (1), Clase F (2), con protector térmico incorporado (3), caja de bornes fuera del flujo de aire conteniendo el condensador en los modelos monofásicos.

- (1) Modelos 250, 315, 355 y 400: Motor de rotor exterior IP54. Modelos 4/710 y 800: IP55.
(2) Temperatura de trabajo: de -40° a +70°C, excepto modelos 250, 315, 355, 400, /4-710 y 800 (hasta +40°C).
(3) Excepto modelos /4-710 y 800.

Motores

De 2, 4 u 6 polos, según versiones.
Regulables por tensión con autotransformador, excepto modelos /4-560/H, /4-630, 710 y T/800.
Modelos trifásicos regulables por convertidor de frecuencia.
Tensión de alimentación
Monofásicos 230V-50Hz
Trifásicos 230/400V-50Hz ó 400V-50Hz
(Ver cuadro de características)

Otros datos

Sentido del aire Hélice-Motor (flujo B).
Motor-Hélice (flujo A), bajo demanda.
Bajo demanda, motores trifásicos de 2 velocidades, 4/8 polos, para Ø de 450 a 800.

TCBT versiones ATEX

Bajo pedido, versiones antiexplosivas según la Directiva ATEX para modelos trifásicos:

Para trabajar a temperaturas de:

- 20°C a +55°C: modelos TCBT/4-315 a 630 mm
modelos TCBT/6-355 a 710 mm
- 20°C a +40°C: modelos TCBT/4-710 a 800 mm
modelos TCBT/6-800 mm

Motores IP55. Clase F.

- ATEX Antideflagrantes - Gas

Para modelos TCBT/4-710 y 800 mm

⊕ II 2G Ex d IIB T4

⊕ II 2G Ex d IIB+H2 T4 (con motor Ex d IIC T4)

En versión ATEX estándar, los motores antideflagrantes se entregan sin protección térmica.

Para utilizar con convertidor de frecuencia pedir motores antideflagrantes con protector térmico tipo PTC.

- ATEX Seguridad aumentada - Gas

- No disponibles TCBT/2-250/H 400V-50Hz
TCBT/4-250/H 400V-50Hz
TCBT/6-355/H 400V-50Hz
TCBT/6-400/H 400V-50Hz

Sí disponibles TCBT/6-400/H 230/400V-50Hz y tamaños mayores.

⊕ II 2G Ex e II T3

- ATEX - Polvo

Para modelos TCBT/4-710 y 800 mm.

Partículas en suspensión inflamables y polvo no conductor:

⊕ II 3D Ex tc IIB T125°C

Polvo conductor:

⊕ II 3D Ex tc IIIC T125°C (con motor IP65)

En versión ATEX estándar, los motores ATEX para polvo se entregan sin protección térmica.

Para utilizar con convertidor de frecuencia pedir motores ATEX para polvo con protector térmico tipo PTC.

Para seleccionar modelos TCBT ATEX, ver el programa de selección de producto EASYVENT. Los datos eléctricos de los modelos ATEX pueden variar respecto a los datos indicados en las tablas características. Consulte la disponibilidad de otras versiones de motores ATEX.



Resistencia a la corrosión

El conjunto camisa-soporte está protegido contra la corrosión mediante tratamiento por cataforésis + pintura poliéster. El diseño aerodinámico del soporte motor reduce el rozamiento al paso del aire.



Caja de bornes ubicada fuera del flujo del aire,

excepto en los modelos ATEX. Contiene el condensador en los modelos monofásicos. Prensaestopas PG-11.

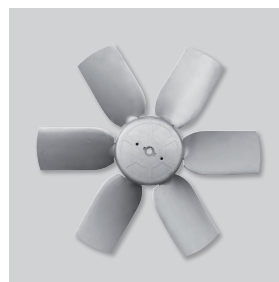

Hélice equilibrada dinámicamente,

según norma ISO 1940, para reducir el ruido y evitar vibraciones.

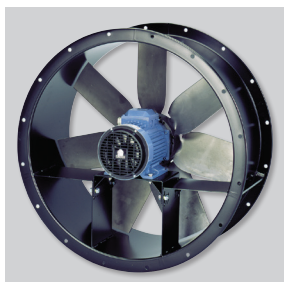

Configuración constructiva modelos /4-710 y 800.



Configuración constructiva modelos 250, 315, 355 y 400. (Excepto modelos 6-355, 6-400 y ATEX)

Aplicaciones específicas



Versiones

CARACTERÍSTICAS TÉCNICAS

Es imprescindible comprobar que las características eléctricas (voltaje, intensidad, frecuencia, etc.) del motor que aparecen en la placa del mismo son compatibles con las de la instalación.

Modelo	Velocidad (r.p.m.)	Ø Boca (mm)	Potencia absorbida máxima (W)	Intensidad máxima (A)		Nivel de presión sonora* (dB(A))	Caudal máximo (m³/h)	Peso (kg)	Regulador de tensión opcional		Convertidor de frecuencia opcional VFTM
				a 230 V	a 400 V				REB	RMB/T	
MONOFASICOS 2 POLOS											
TCBB/2-250/H	2680	250	123	0,5	–	62	1.680	8	–	–	–
MONOFASICOS 4 POLOS											
TCBB/4-250/H	1430	250	44	0,2	–	42	900	8	REB-1	RMB-1,5	–
TCBB/4-315/H	1435	315	105	0,6	–	52	1.990	11	REB-1	RMB-1,5	–
TCBB/4-355/H	1420	355	120	0,6	–	52	2.460	13,2	REB-2,5	RMB-1,5	–
TCBB/4-400/H	1410	400	277	1,1	–	60	5.050	15,5	REB-2,5	RMB-3,5	–
TCBB/4-450/H	1410	450	591	2,5	–	63	6.940	21	–	–	–
TCBB/4-500/H	1410	500	636	2,8	–	66	7.500	25	REB-5	RMB-3,5	–
TCBB/4-560/L	1405	560	1289	6	–	68	11.990	33	REB-10	RMB-8	–
TCBB/4-560/H	1400	560	1308	6	–	69	12.170	34,7	–	–	–
TCBB/4-630/L	1365	630	1707	7,5	–	70	15.980	40	–	–	–
MONOFASICOS 6 POLOS											
TCBB/6-355/H	880	355	92	0,4	–	46	2.160	13,2	REB-1	RMB-1,5	–
TCBB/6-400/H	870	400	118	0,5	–	48	2.820	15,5	REB-1	RMB-1,5	–
TCBB/6-500/H	920	500	226	1	–	57	5.250	24,8	REB-2,5	RMB-1,5	–
TCBB/6-560/L	930	560	375	1,6	–	60	7.810	33,5	REB-5	RMB-3,5	–
TCBB/6-630/L	920	630	514	2,1	–	60	10.410	38,5	REB-5	RMB-8	–
TCBB/6-710/L	930	710	849	4,2	–	62	14.480	46	–	–	–
TRIFASICOS 2 POLOS											
TCBT/2-250/H	2775	250	114	0,3	0,2	62	1.730	8	–	–	TRI-0,37
TRIFASICOS 4 POLOS											
TCBT/4-250/H	1470	250	42	0,3	0,2	42	900	8	–	RMT-1,5	TRI-0,37
TCBT/4-315/H	1445	315	99	0,5	0,3	51	1.950	11	–	RMT-1,5	TRI-0,37
TCBT/4-355/H	1415	355	117	0,5	0,3	52	2.470	13,2	–	RMT-1,5	TRI-0,37
TCBT/4-400/H	1410	400	268	0,9	0,5	60	4.950	15,5	–	RMT-1,5	TRI-0,37
TCBT/4-450/H	1405	450	526	1,9	1,1	63	6.650	21	–	RMT-2,5	TRI-0,55
TCBT/4-500/H	1420	500	641	2,6	1,5	66	7.590	25	–	RMT-2,5	TRI-0,55
TCBT/4-560/L	1415	560	1184	3,8	2,2	68	12.090	33	–	RMT-2,5	TRI-0,75
TCBT/4-560/H	1390	560	1348	4,2	2,4	69	13.370	34,7	–	–	TRI-1,1
TCBT/4-630/L	1410	630	1768	5,9	3,4	70	16.370	39	–	–	TRI-1,5
TCBT/4-630/H	1400	630	1940	6,2	3,6	70	17.030	40	–	–	TRI-1,5
TCBT/4-710/L	1435	710	2175	6,4	3,7	73	20.290	46	–	–	TRI-1,5
TCBT/4-710/H	1460	710	3441	10,6	6,1	73	26.420	54	–	–	TRI-3
TCBT/4-800/L	1460	800	3750	11,3	6,5	76	29.950	65	–	–	TRI-3
TCBT/4-800/K	1460	800	5177	–	8,8	76	34.950	68	–	–	TRI-4
TCBT/4-800/G	1470	800	6146	–	11,1	77	38.500	81	–	–	TRI-5,5
TCBT/4-800/H	1475	800	7688	–	13	78	42.490	89	–	–	TRI-5,5
TRIFASICOS 6 POLOS											
TCBT/6-355/H	900	355	97	0,4	0,2	47	2.250	13,2	–	RMT-1,5	TRI-0,37
TCBT/6-400/H	860	400	116	0,4	0,2	49	2.970	15,5	–	RMT-1,5	TRI-0,37
TCBT/6-450/H	940	450	161	0,7	0,4	54	4.020	20,7	–	RMT-1,5	TRI-0,37
TCBT/6-500/H	930	500	198	0,9	0,5	57	4.990	24,8	–	RMT-1,5	TRI-0,37
TCBT/6-560/H	920	560	363	1,4	0,8	60	7.630	33,5	–	RMT-2,5	TRI-0,55
TCBT/6-630/L	915	630	595	–	1,3	60	10.940	38	–	RMT-2,5	TRI-0,55
TCBT/6-630/H	950	630	906	–	2,7	62	13.610	38,5	–	RMT-5	TRI-1,1
TCBT/6-710/L	910	710	967	3,5	2,0	62	16.240	46	–	–	TRI-1,1
TCBT/6-710/H	910	710	1378	5,4	3,1	63	19.120	46	–	–	TRI-1,1
TCBT/6-800/L	965	800	1278	4,7	2,7	66	20.770	57	–	–	TRI-1,1
TCBT/6-800/K	975	800	1592	5,7	3,3	66	24.090	64	–	–	TRI-1,5
TCBT/6-800/G	975	800	1968	8,0	4,6	67	26.310	68	–	–	TRI-2,2
TCBT/6-800/H	970	800	2345	8,7	5	68	27.910	80	–	–	TRI-2,2

* Ver apartado de características acústicas.

REFERENCIA

T	C	B	T	/	4	-	4	0	0	/	H	-	B	4	0	0	V	5	0	Hz				
1	2	3	4		5		6				7		8	9				10						11

- 1 - **T**: Helicoidal tubular.
- 2 - **C**: Sigla de la serie.
- 3 - Tipo de hélice:
B: Ø 250 - Ø 400 Hélice de aluminio de álabes fijos.
Ø 450 - Ø 800 Hélice de aluminio de álabes orientables.
- 4 - Tipo de alimentación:
B: Monofásico
T: Trifásico
- 5 - Número de polos:
2: {aprox. 2800 r.p.m. - 50 Hz}
4: {aprox. 1400 r.p.m. - 50 Hz}
6: {aprox. 900 r.p.m. - 50 Hz}
- 6 - Diámetro nominal del ventilador en mm.
- 7 - Angulo de inclinación de los álabes.
- 8 - Sentido del aire:
A: Motor-Hélice
B: Hélice-Motor
- 9 - Tensión de alimentación:
230 V (monofásico)
230/400 V (trifásico)
400 V (trifásico)
- 10 - Variantes de servicio: 50 Hz
60 Hz
- 11 - Variantes de fabricación:
2 V: Motores de dos velocidades
4/8 polos de motor para los modelos Ø 450 hasta Ø 800 mm.
6/12 polos de motor para los modelos desde Ø 710 hasta Ø 800 mm.
C: Eliminación de condensaciones.
EX: Versiones antiexplosivas y antideflagrantes.

CONEXIÓN ELÉCTRICA



Tipo de red eléctrica	Tipo de motor	Conexión	Velocidad
MONOFÁSICA 220V 50Hz, 240V 50Hz	230V 50Hz	Según esquema del aparato	Rápida
TRIFÁSICA 220V 50Hz 240V 50Hz	230/400V 50Hz		Rápida
			Lenta*
TRIFÁSICA 380V 50Hz 415V 50Hz	230/400V 50Hz		Rápida
			Rápida
			Lenta*
	400V 50Hz		

* Para los modelos que admiten regulación en tensión mediante RMT

CARACTERÍSTICAS ACÚSTICAS

El nivel sonoro indicado en los cuadros de características técnicas y en las curvas características, corresponde a un valor de presión en dB(A), medido en campo libre a una distancia equivalente a tres veces el diámetro de la hélice con un mínimo de 1,5 metros y en el punto de máximo caudal.

Espectro de potencia sonora en dB(A) por banda de frecuencia en Hz y en el punto medio de la curva característica.

Modelo	63	125	250	500	1000	2000	4000	8000	LwA
/2-250/H	31	44	59	65	74	70	64	56	76

Modelo	63	125	250	500	1000	2000	4000	8000	LwA
/4-250/H	24	37	41	47	52	52	47	41	57
/4-315/H	40	51	45	53	59	59	51	43	63
/4-355/H	24	40	45	55	58	58	49	42	62
/4-400/H	46	53	59	66	69	69	66	58	74
/4-450/H	46	58	65	71	73	71	67	59	77
/4-500/H	50	62	69	75	76	75	70	62	81
/4-560/L	52	64	71	77	78	77	72	64	83
/4-560/H	53	65	72	78	79	78	73	65	84
/4-630/L	56	67	75	80	82	81	76	68	87
/4-630/H	56	67	75	80	82	81	76	68	87
/4-710/L	53	69	79	85	86	84	78	70	91
/4-710/H	60	72	79	85	86	85	80	72	91
/4-800/L	57	73	83	90	91	88	82	74	95
/4-800/K	63	75	82	88	90	88	84	76	94
/4-800/G	64	76	83	89	90	89	84	76	95
/4-800/H	66	77	84	90	92	91	86	78	96

Modelo	63	125	250	500	1000	2000	4000	8000	LwA
/6-355/H	31	42	49	55	57	55	51	43	61
/6-400/H	33	44	51	57	59	58	53	45	64
/6-450/H	40	51	58	63	64	62	56	48	69
/6-500/H	43	53	61	66	66	64	58	50	71
/6-560/L	46	57	64	69	70	67	61	53	74
/6-560/H	46	56	64	69	69	67	61	53	74
/6-630/L	49	59	66	71	72	70	64	56	77
/6-630/H	51	61	68	73	74	72	66	58	79
/6-710/L	52	62	69	75	75	73	67	59	80
/6-710/H	53	64	71	76	77	75	69	61	82
/6-800/L	51	66	76	79	79	76	69	61	84
/6-800/K	51	66	76	79	79	76	69	61	84
/6-800/G	56	67	74	79	80	78	72	64	85
/6-800/H	58	69	76	81	82	79	73	65	86

DIMENSIONES (mm)

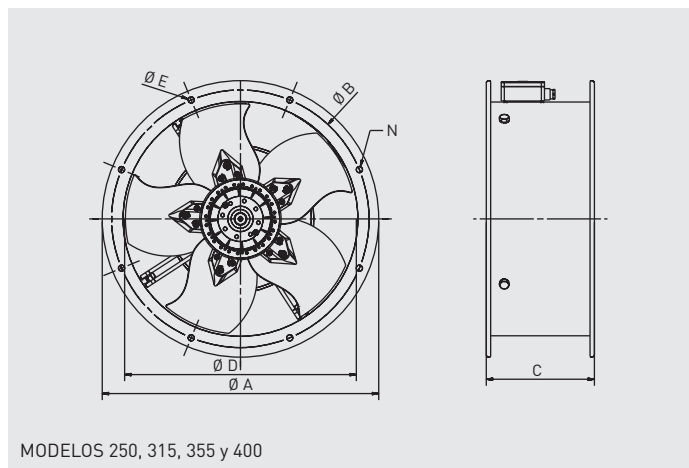

MODELOS 250, 315, 355 y 400

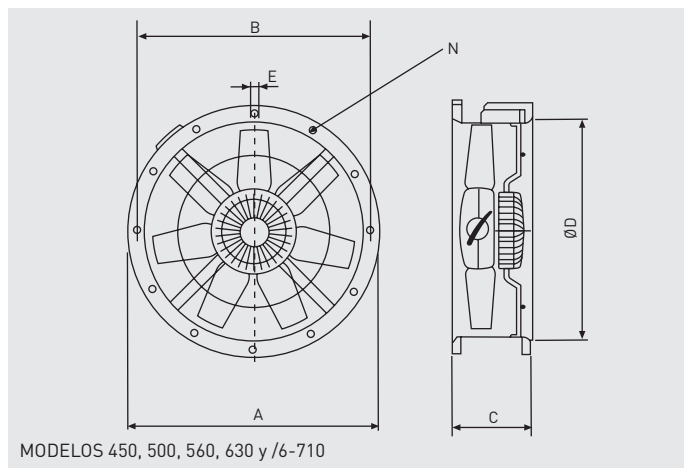

MODELOS 450, 500, 560, 630 y /6-710

Modelo	Ø A	Ø B	C	Ø D	Ø E	Núm. de taladros N
250	327	292	170	254	10	4
315	386	355	170	315	10	8
355	426	395	170	355	10	8
400 (6 polos)	487	450	170	400	12	8
400 (4 polos)	487	450	210	400	12	8
450	537	500	180	450	12	8
500	595	560	180	500	12	12
560	655	620	240	560	12	12
630	725	690	240	630	12	12
710 (6 polos)	806	770	240	710	12	16

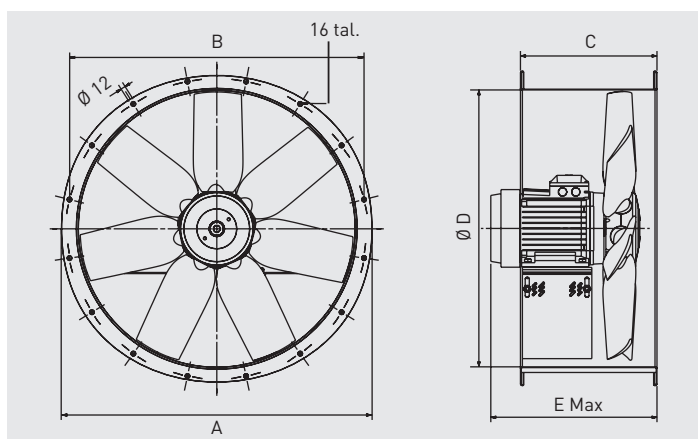

Modelo	Ø A	B	C	Ø D	E		
					4 polos	6 polos	8 polos
710/L (4 polos)	806	770	380	710	415	-	-
710/H (4 polos)	806	770	380	710	444	-	-
800/L	896	860	380	800	437	408	383
800/K	896	860	380	800	448	437	408
800/G	896	860	380	800	447 (5,5kW) 515 (7,5kW)	448	437
800/H	896	860	380	800	515	477	437

ACCESORIOS DE MONTAJE

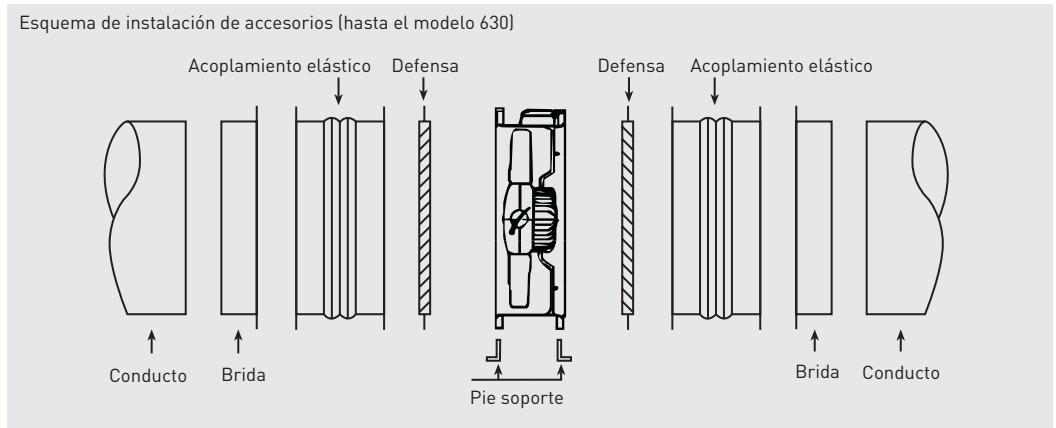

Modelo	Defensas		Bridas	Pie soporte	Embocadura-Defensa	Acoplamiento elástico	Acoplamiento elástico antiexplosivo (ATEX)
	Aspiración (lado hélice)	Descarga (lado motor)					
TCBB / TCBT 250	DEF-250 T	DEF-250 T	ARO BRIDA COMPACT-250	PIE-250	-	ACOP.BRIDA-250	ACOPEL EX 250/160 N
TCBB / TCBT 315	DEF-315 T	DEF-315 T	ARO BRIDA COMPACT-315	PIE-315	EMB-315 T	ACOP.BRIDA-315	ACOPEL EX 315/160 N
TCBB / TCBT 355	DEF-355 T	DEF-355 T	ARO BRIDA COMPACT-355	PIE-355	EMB-355 T	ACOP.BRIDA-355	ACOPEL EX 355/160 N
TCBB / TCBT 400	DEF-400 T	DEF-400 T	ARO BRIDA COMPACT-400	PIE-400	EMB-400 T	ACOP.BRIDA-400	ACOPEL EX 400/160 N
TCBB / TCBT 450	DEF-450 T	DEF-450 T	ARO BRIDA COMPACT-450	PIE-450	EMB-450 T	ACOP.BRIDA-450	ACOPEL EX 450/160 N
TCBB / TCBT 500	DEF-500 T	DEF-500 T	ARO BRIDA COMPACT-500	PIE-500	EMB-500 T	ACOP.BRIDA-500	ACOPEL EX 500/160 N
TCBB / TCBT 560	DEF-560 T	DEF-560 T	ARO BRIDA COMPACT-560	PIE-560	EMB-560 T	ACOP.BRIDA-560	ACOPEL EX 560/160 N
TCBB / TCBT 630	DEF-630 T	DEF-630 T	ARO BRIDA COMPACT-630	PIE-630	EMB-630 T	ACOP.BRIDA-630	ACOPEL EX 630/160 N
TCBT 4-710/H	DEF-710 T ASPIRACION	DEF-710 H-T DESCARGA	ARO BRIDA COMPACT-710	PIE-710	EMB-710 T	ACOP.BRIDA-710	ACOPEL EX 710/160 N
TCBT 4-710/L	DEF-710 T ASPIRACION	DEF-710 L-T DESCARGA	ARO BRIDA COMPACT-710	PIE-710	EMB-710 T	ACOP.BRIDA-710	ACOPEL EX 710/160 N
TCBB / TCBT 6-710	DEF-710 T ASPIRACION	DEF-710 T ASPIRACION	ARO BRIDA COMPACT-710	PIE-710	EMB-710 T	ACOP.BRIDA-710	ACOPEL EX 710/160 N
TCBT 800	DEF-800 T ASPIRACION	DEF.DESC.TGT/THGT-800*	ARO BRIDA COMPACT-800	PIE-800	EMB-800 T	ACOP.BRIDA-800	ACOPEL EX 800/160 N

* Para más información ver "accesorios de montaje".

ACCESORIOS ELÉCTRICOS



REB-1N / REB-2,5N
Reguladores electrónicos monofásicos.



REB-5 / REB-10
Reguladores electrónicos monofásicos.



RMB/RMT
Reguladores electromecánicos monofásicos y trifásicos.



VFTM TRI IP54
Convertidores de frecuencia para motores de 0,37 a 15 kW, 230-400V.



COM D/S
Conmutador estrella/ triángulo, para el arranque de los ventiladores trifásicos dotados de motor 400V.

CURVAS CARACTERÍSTICAS TCBB/TCBT

- q_v = Caudal en m^3/h y m^3/s .
- p_{sf} = Presión estática en mmcda y Pa.
- SFP: Factor específico de potencia en $W/m^3/s$.
- P: Potencia absorbida en W.
- Categoría de medición: C ó D, según modelos.
- Categoría de eficiencia: estática o total, según modelos.
- Eficiencia del ventilador sin mando de regulación de velocidad.
- Caudal de acuerdo a la Norma ISO 5801.
- Nivel de presión sonora en dB(A), medido en campo libre a una distancia equivalente a 3 veces el diámetro, con un mínimo de 1,5 m.

MC	Categoría de medición
EC	Categoría de eficiencia
VSD	Mando de regulación de velocidad: debe suministrarse con el ventilador
SR	Relación específica
η[%]	Eficiencia
N	Grado de eficiencia
[kW]	Potencia absorbida
[m³/h]	Caudal
[Pa]	Presión estática
[RPM]	Velocidad

CURVAS CARACTERÍSTICAS - MOTORES DE 2 POLOS

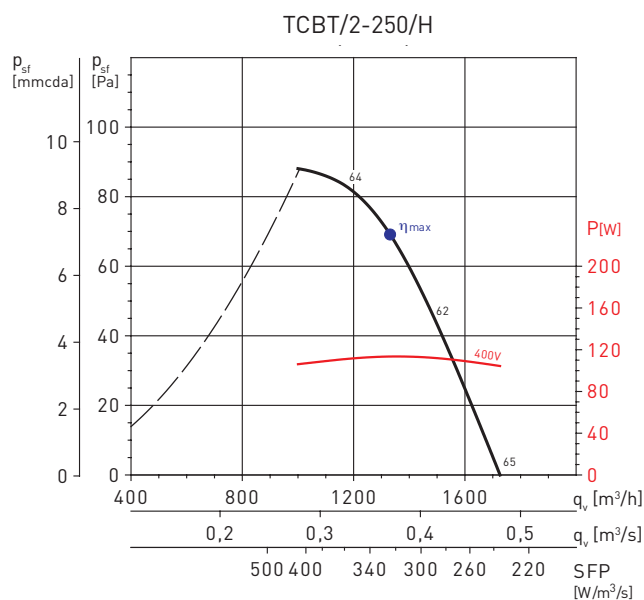
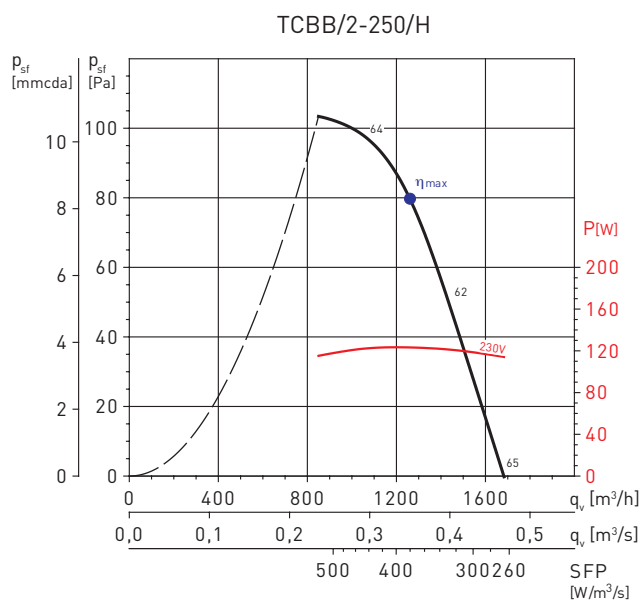

CURVAS CARACTERÍSTICAS - MOTORES DE 4 POLOS

TCBB/4-250/H

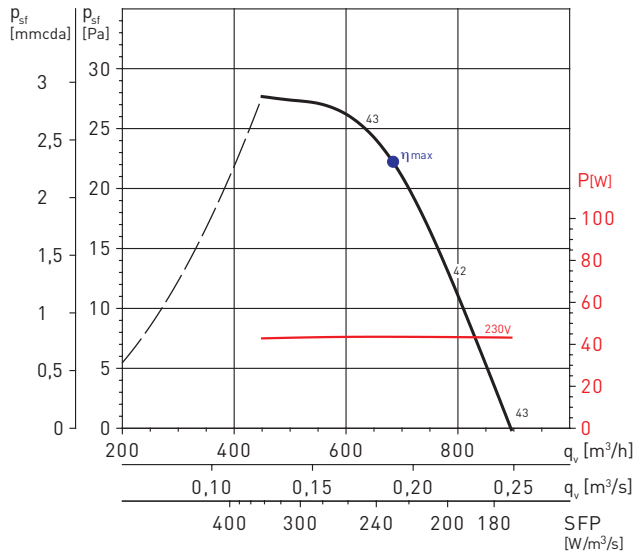

TCBB/4-315/H

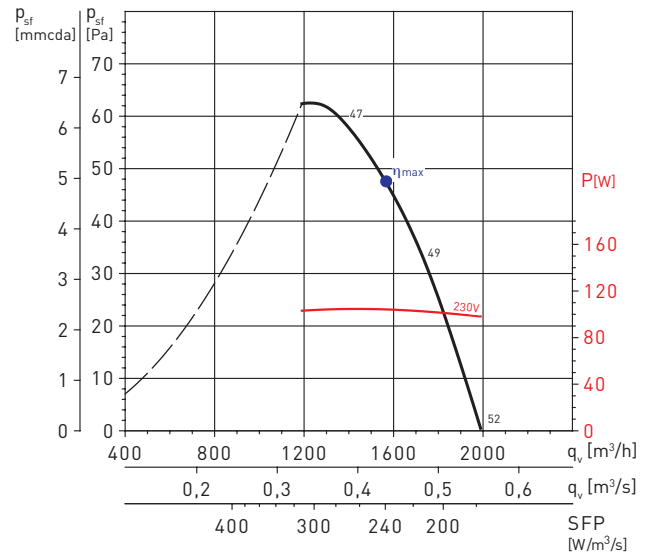

TCBB/4-355/H

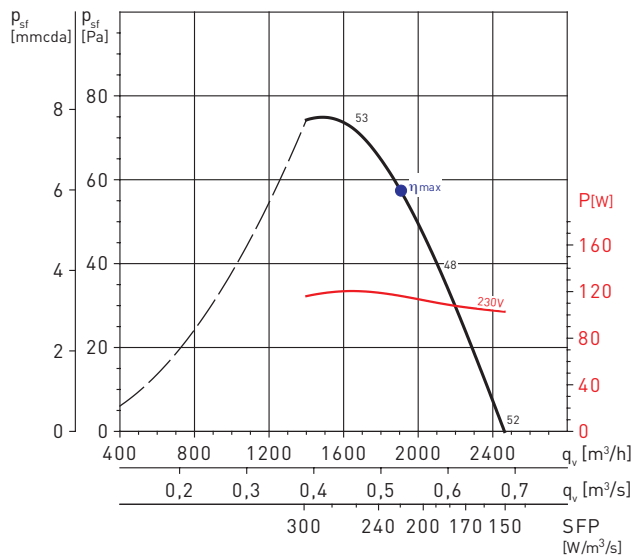

TCBB/4-400/H

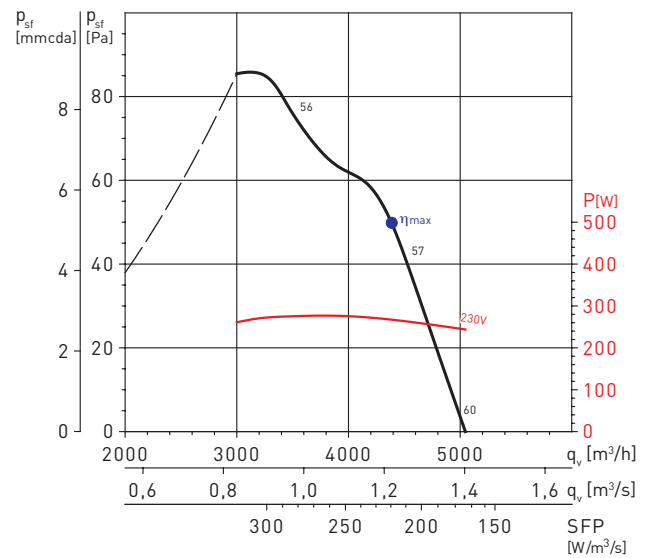

MC	EC	VSD	SR	η [%]	N	[kW]	[m^3/h]	[Pa]	[RPM]
D	Total	No	1	48,5	58,4	0,267	4386	106	1397

CURVAS CARACTERÍSTICAS - MOTORES DE 4 POLOS

TCBB/4-450/H

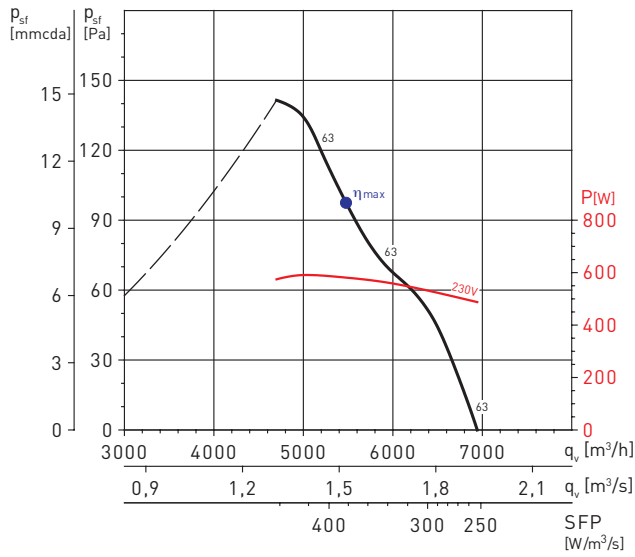

MC	EC	VSD	SR	η[%]	N	[kW]	[m³/h]	[Pa]	[RPM]
C	Static	No	1	32,3	40,1	0,582	4783	142	1368

TCBB/4-500/H

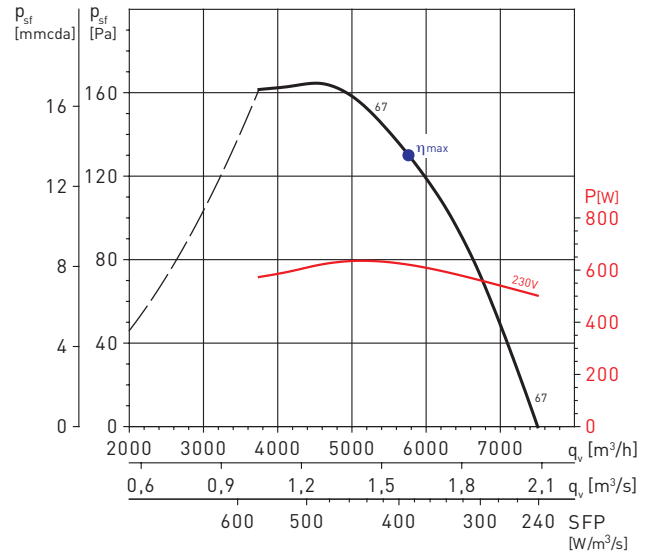

MC	EC	VSD	SR	η[%]	N	[kW]	[m³/h]	[Pa]	[RPM]
C	Static	No	1	34,5	42,1	0,636	5075	156	1367

TCBB/4-560/L

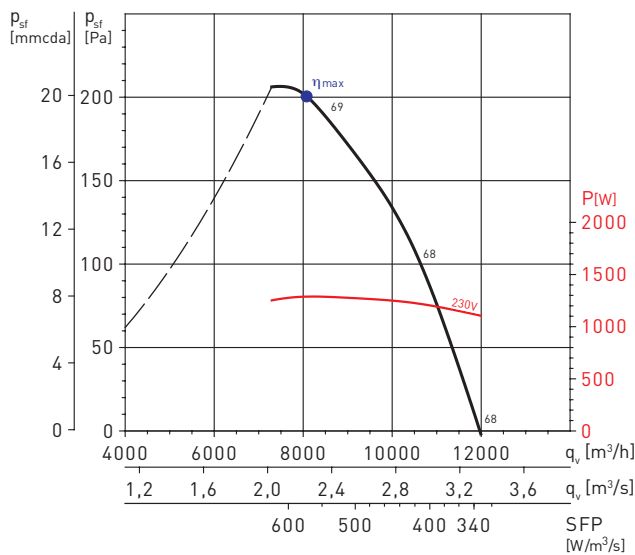

MC	EC	VSD	SR	η[%]	N	[kW]	[m³/h]	[Pa]	[RPM]
C	Static	No	1	34,7	40,3	1,288	8071	200	1382

TCBB/4-560/H

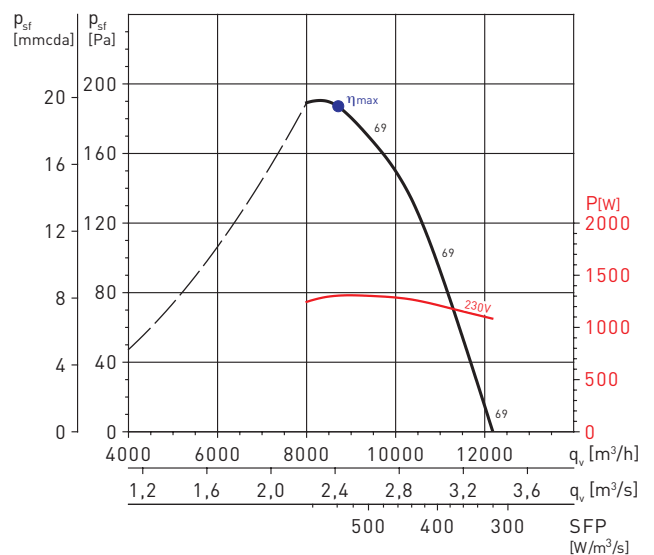

MC	EC	VSD	SR	η[%]	N	[kW]	[m³/h]	[Pa]	[RPM]
C	Static	No	1	34,6	40,2	1,305	8700	187	1370

CURVAS CARACTERÍSTICAS - MOTORES DE 4 POLOS

TCBB/4-630/L

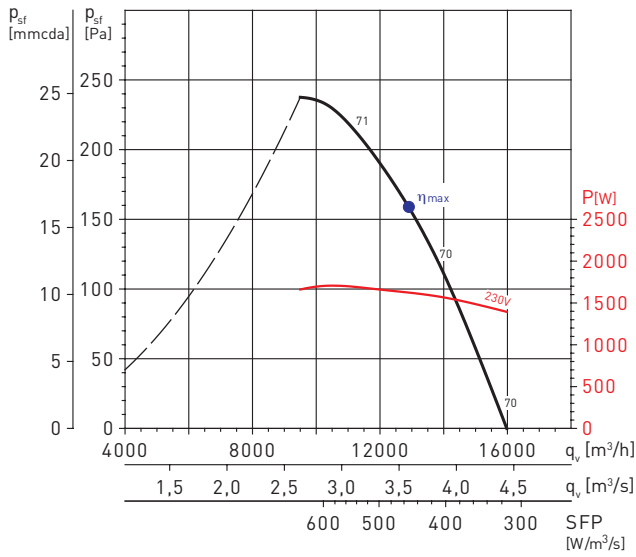

MC	EC	VSD	SR	η [%]	N	[kW]	[m³/h]	[Pa]	[RPM]
D	Total	No	1	53,4	58,4	1,624	12.896	241	1332

TCBT/4-250/H

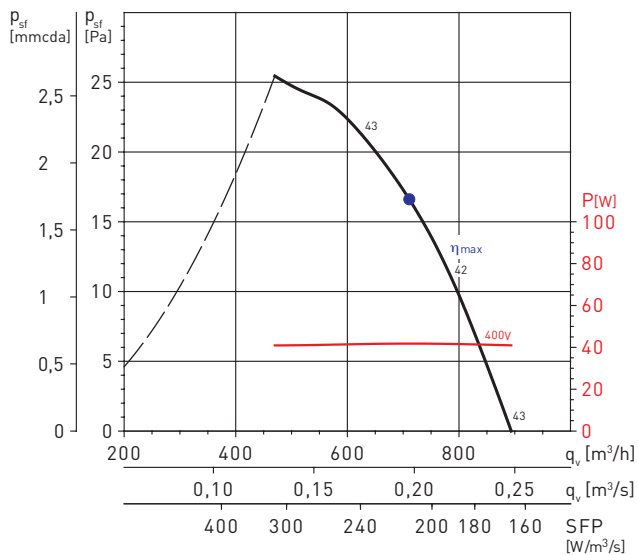

TCBT/4-315/H

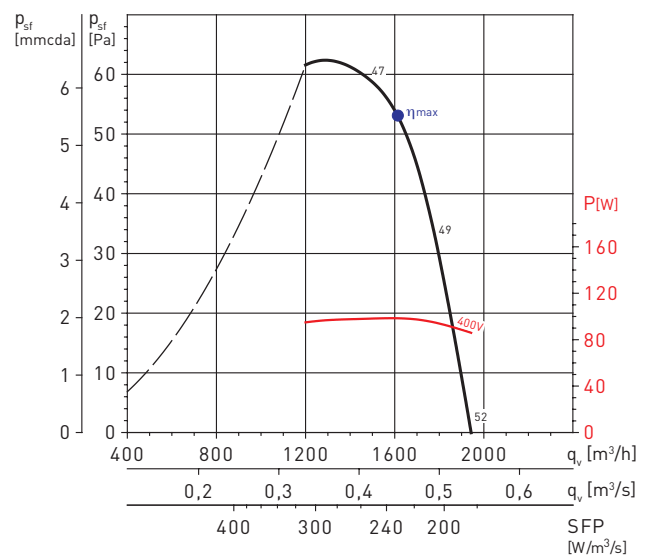

CURVAS CARACTERÍSTICAS - MOTORES DE 4 POLOS

TCBT/4-355/H

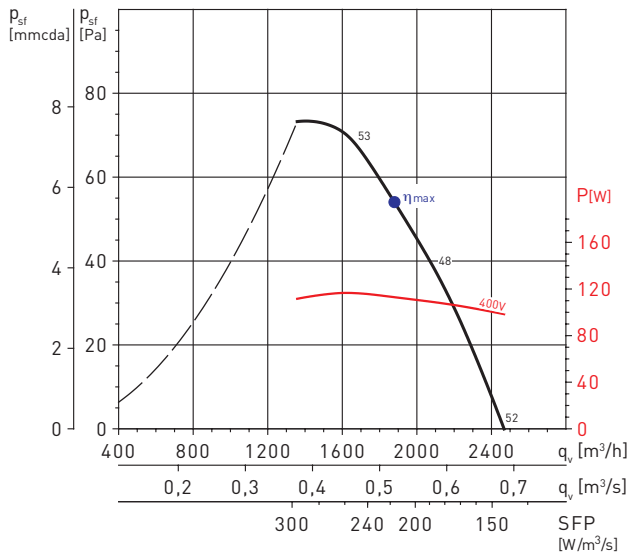

TCBT/4-400/H

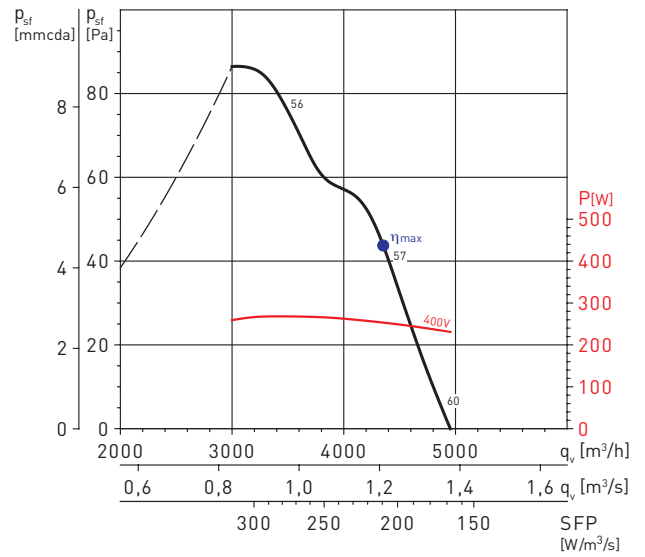

MC	EC	VSD	SR	η [%]	N	[kW]	[m³/h]	[Pa]	[RPM]
D	Total	No	1	47,9	58,0	0,255	4281	103	1391

TCBT/4-450/H

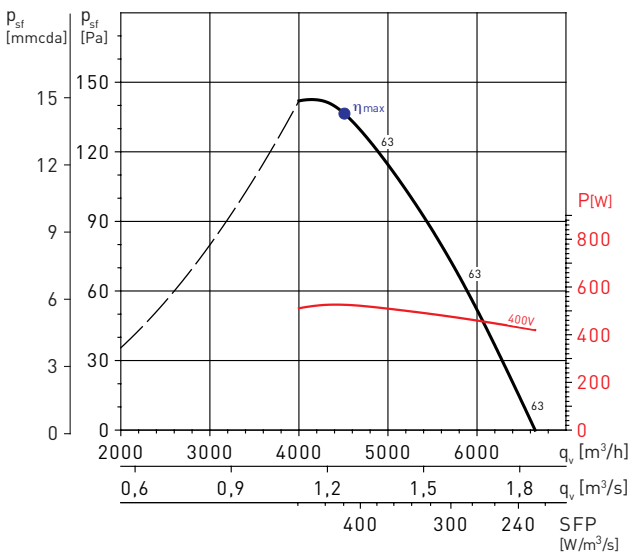

TCBT/4-500/H

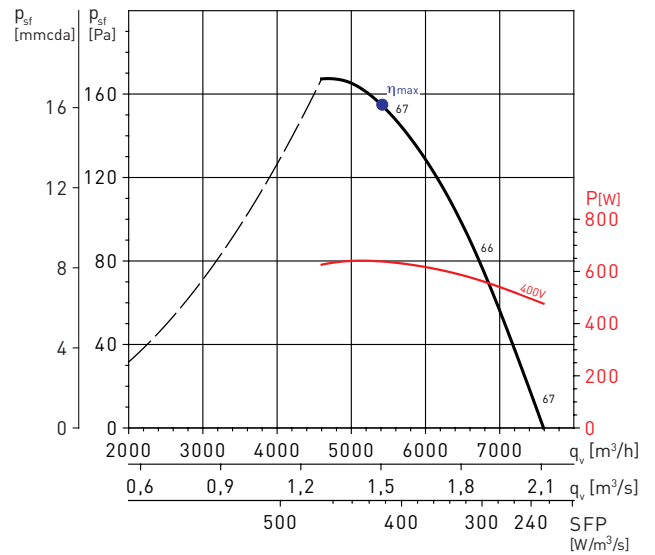

MC	EC	VSD	SR	η [%]	N	[kW]	[m³/h]	[Pa]	[RPM]
C	Static	No	1	32,4	40,5	0,526	4510	136	1374

MC	EC	VSD	SR	η [%]	N	[kW]	[m³/h]	[Pa]	[RPM]
C	Static	No	1	36,3	43,9	0,638	5409	155	1381

CURVAS CARACTERÍSTICAS - MOTORES DE 4 POLOS

TCBT/4-560/L

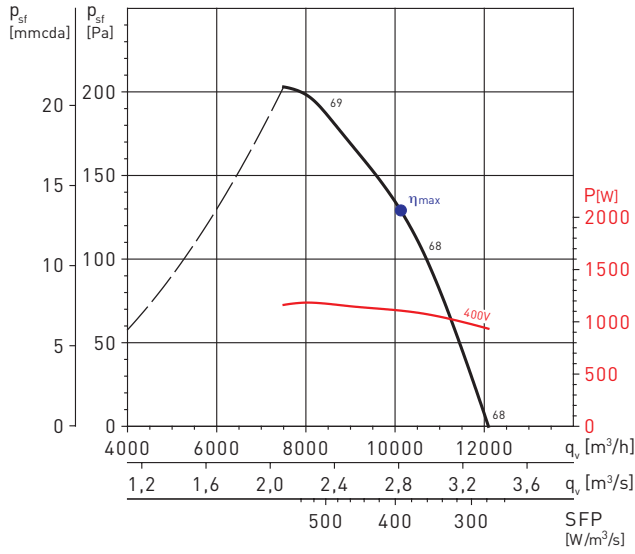

MC	EC	VSD	SR	η [%]	N	[kW]	[m³/h]	[Pa]	[RPM]
D	Total	No	1	53,2	59,3	1,107	10127	208	1390

TCBT/4-560/H

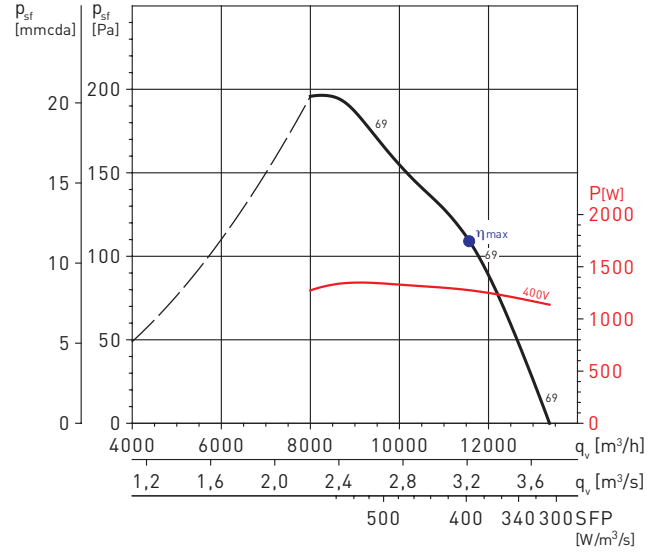

MC	EC	VSD	SR	η [%]	N	[kW]	[m³/h]	[Pa]	[RPM]
D	Total	No	1	53,4	59,1	1,275	11576	212	1372

TCBT/4-630/L

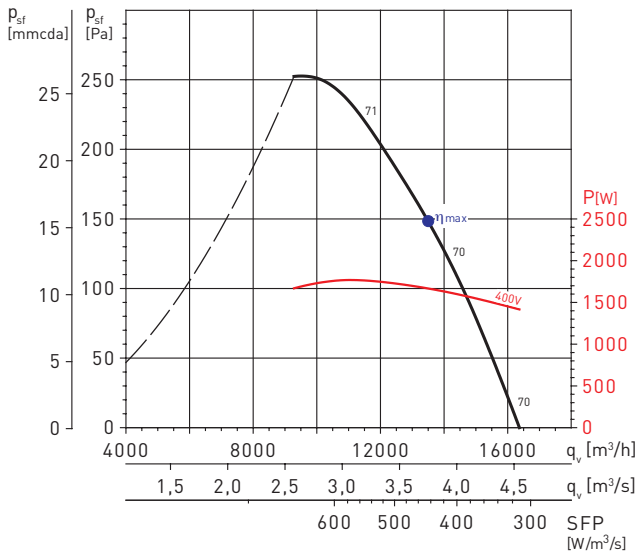

MC	EC	VSD	SR	η [%]	N	[kW]	[m³/h]	[Pa]	[RPM]
D	Total	No	1	53,4	58,3	1,667	13505	236	1390

TCBT/4-630/H

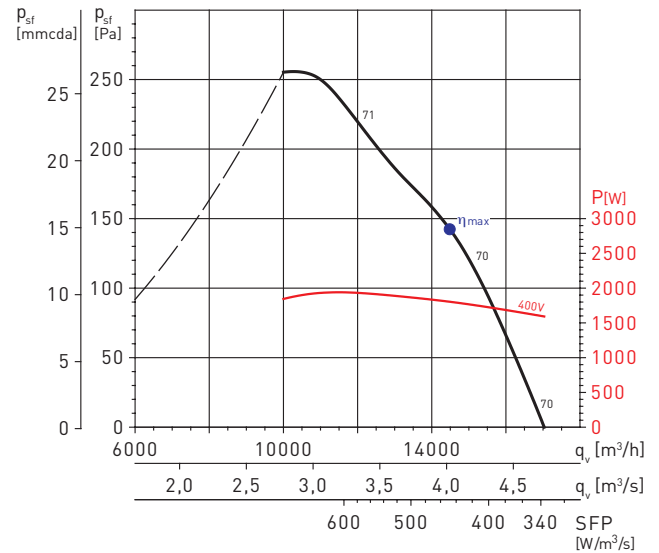

MC	EC	VSD	SR	η [%]	N	[kW]	[m³/h]	[Pa]	[RPM]
D	Total	No	1	54,4	59,1	1,804	14481	244	1383

CURVAS CARACTERÍSTICAS - MOTORES DE 4 POLOS

TCBT/4-710/L

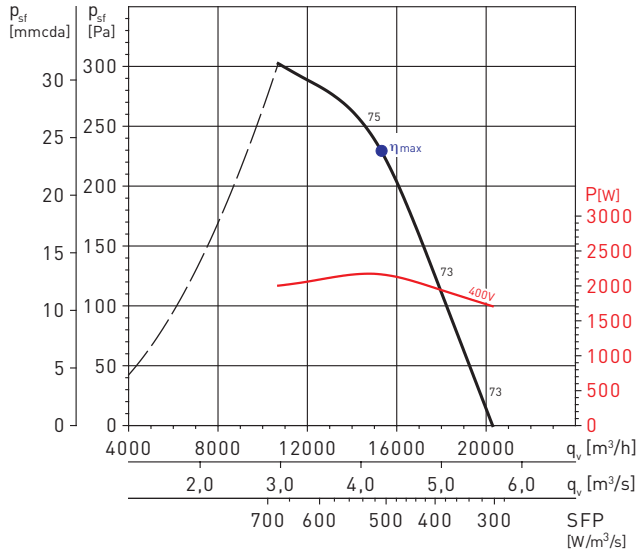

MC	EC	VSD	SR	η [%]	N	[kW]	[m^3/h]	[Pa]	[RPM]
D	Total	No	1	58,7	62,9	2,166	15306	299	1414

TCBT/4-710/H

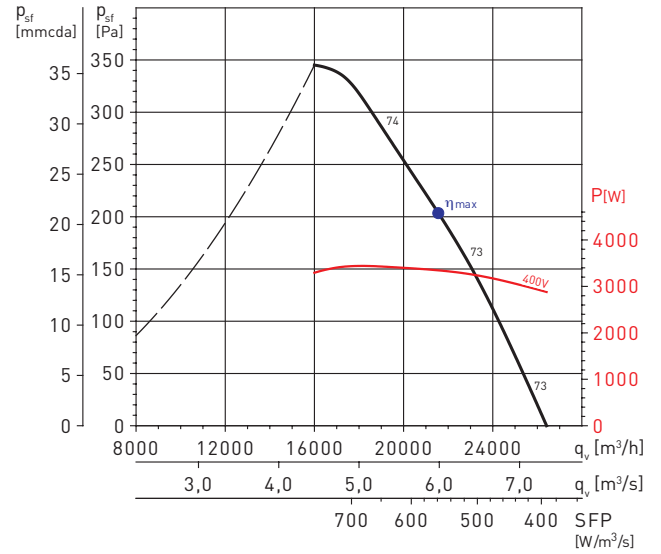

MC	EC	VSD	SR	η [%]	N	[kW]	[m^3/h]	[Pa]	[RPM]
D	Total	No	1	61,4	64,4	3,346	21563	341	1451

TCBT/4-800/L

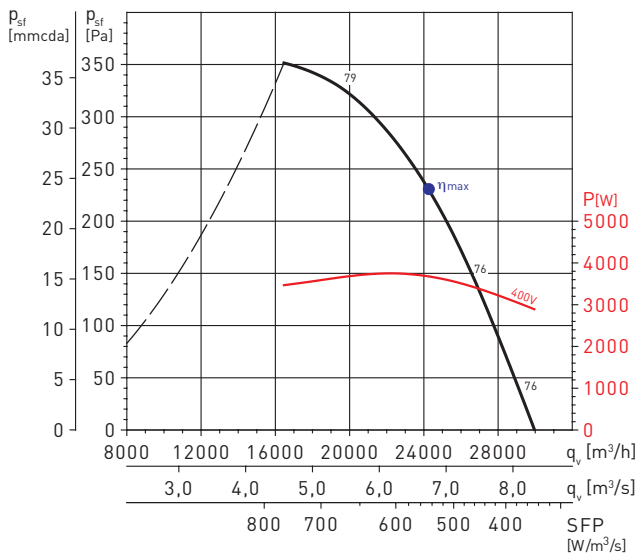

MC	EC	VSD	SR	η [%]	N	[kW]	[m^3/h]	[Pa]	[RPM]
D	Total	No	1	62,4	65,2	3,678	24248	339	1445

TCBT/4-800/K

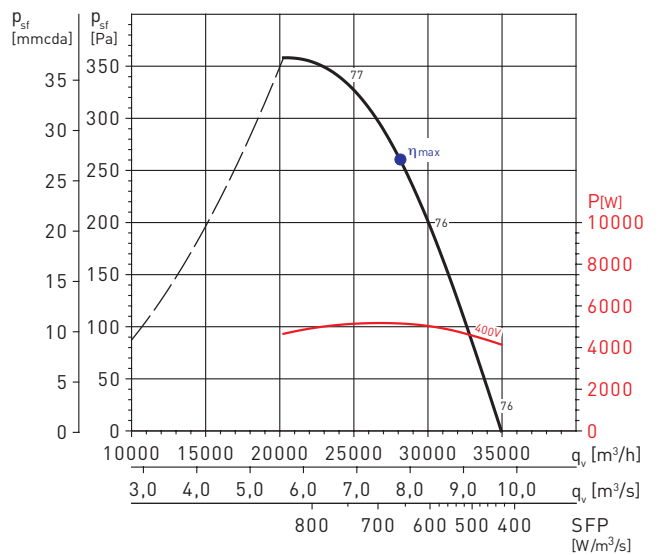

MC	EC	VSD	SR	η [%]	N	[kW]	[m^3/h]	[Pa]	[RPM]
D	Total	No	1	61,6	63,4	5,156	28120	406	1445

CURVAS CARACTERÍSTICAS - MOTORES DE 4 POLOS

TCBT/4-800/G

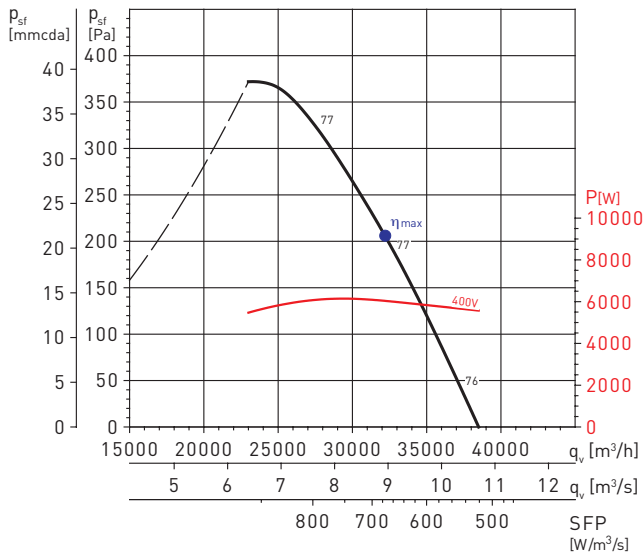

MC	EC	VSD	SR	η [%]	N	[kW]	[m ³ /h]	[Pa]	[RPM]
D	Total	No	1	58,9	60,3	6,038	32195	397	1460

TCBT/4-800/H

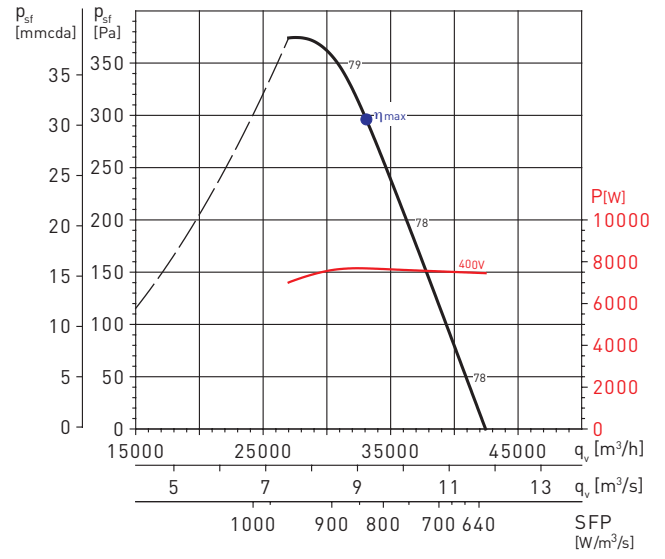

MC	EC	VSD	SR	η [%]	N	[kW]	[m ³ /h]	[Pa]	[RPM]
D	Total	No	1	59,6	60,3	7,682	33100	498	1468

CURVAS CARACTERÍSTICAS - MOTORES DE 6 POLOS

TCBB/6-355/H

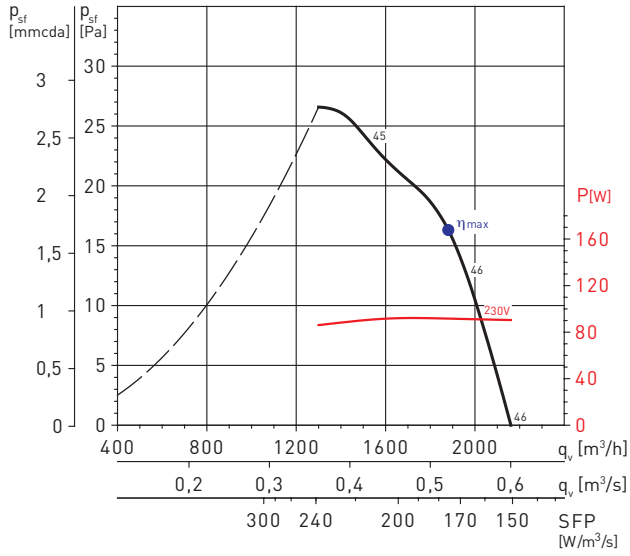

TCBB/6-400/H

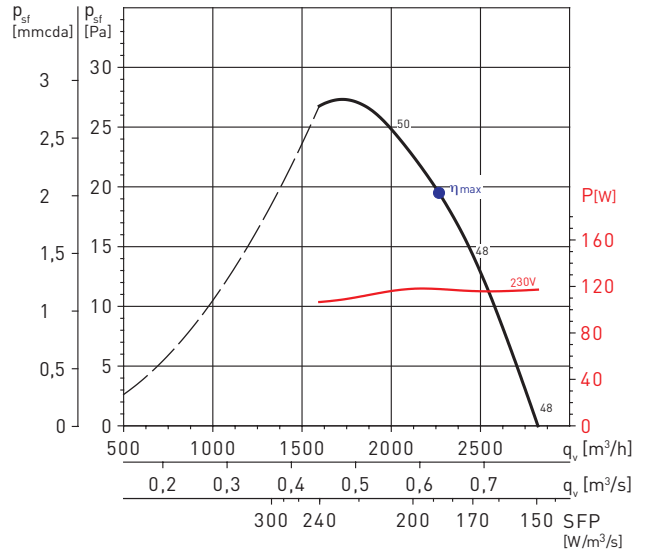

TCBB/6-500/H

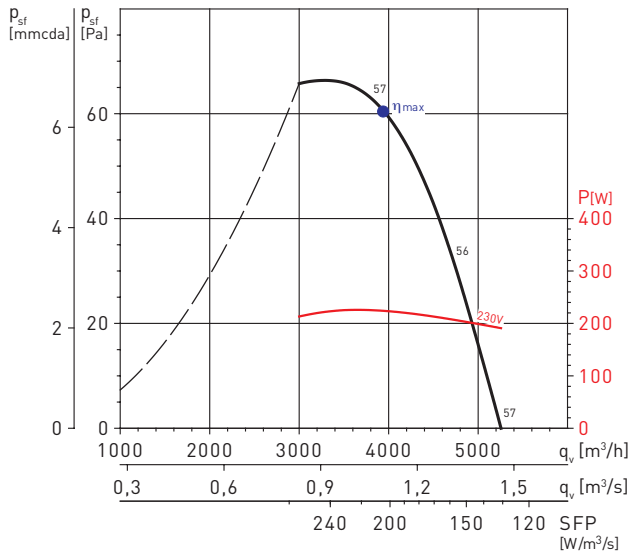

TCBB/6-560/L

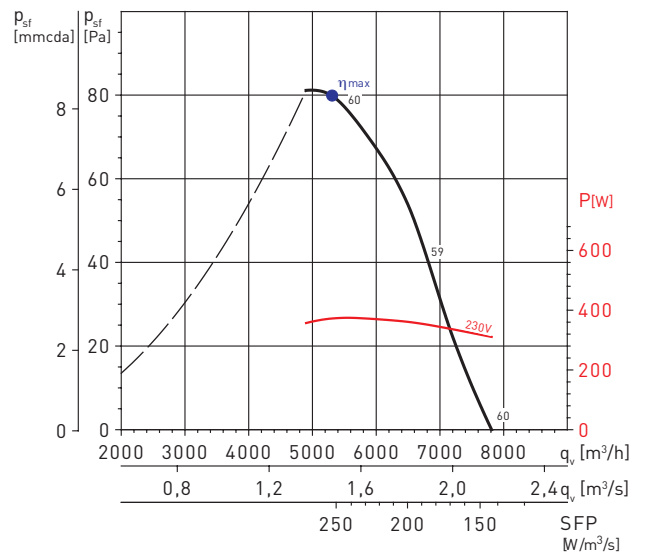

MC	EC	VSD	SR	η[%]	N	[kW]	[m³/h]	[Pa]	[RPM]
C	Static	No	1	29,6	40,0	0,224	3945	61	886

MC	EC	VSD	SR	η[%]	N	[kW]	[m³/h]	[Pa]	[RPM]
C	Static	No	1	31,6	40,6	0,372	5306	80	894

CURVAS CARACTERÍSTICAS - MOTORES DE 6 POLOS

TCBB/6-630/L

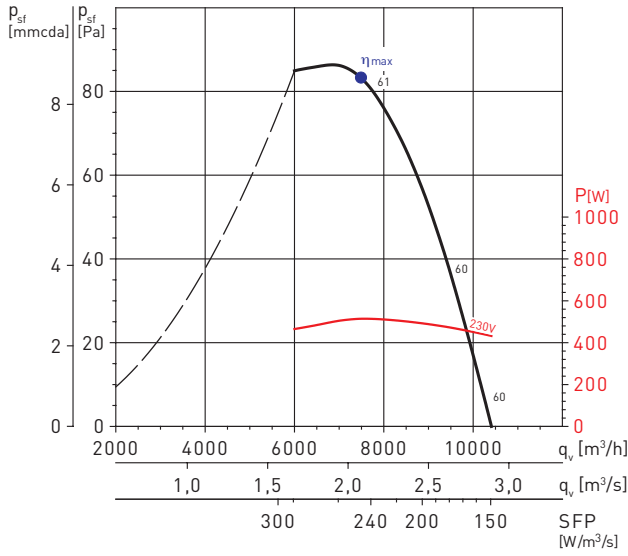

MC	EC	VSD	SR	η [%]	N	[kW]	[m ³ /h]	[Pa]	[RPM]
C	Static	No	1	33,7	41,9	0,514	7499	83	889

TCBB/6-710/L

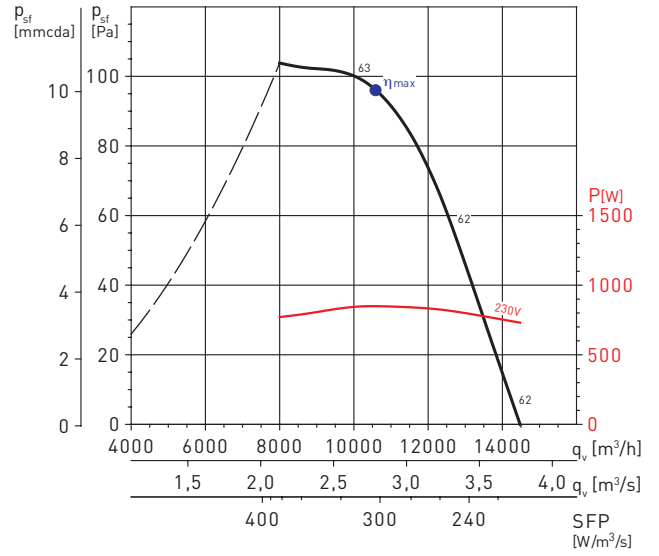

MC	EC	VSD	SR	η [%]	N	[kW]	[m ³ /h]	[Pa]	[RPM]
C	Static	No	1	33,3	40,1	0,849	10587	96	901

TCBT/6-355/H

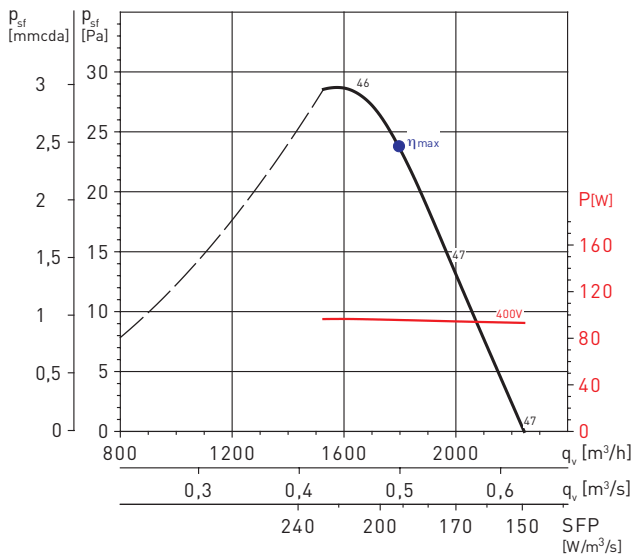

TCBT/6-400/H

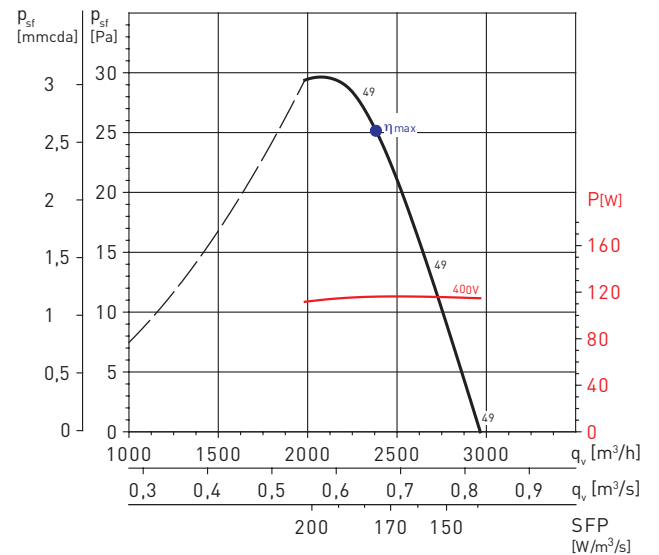

CURVAS CARACTERÍSTICAS - MOTORES DE 6 POLOS

TCBT/6-450/H

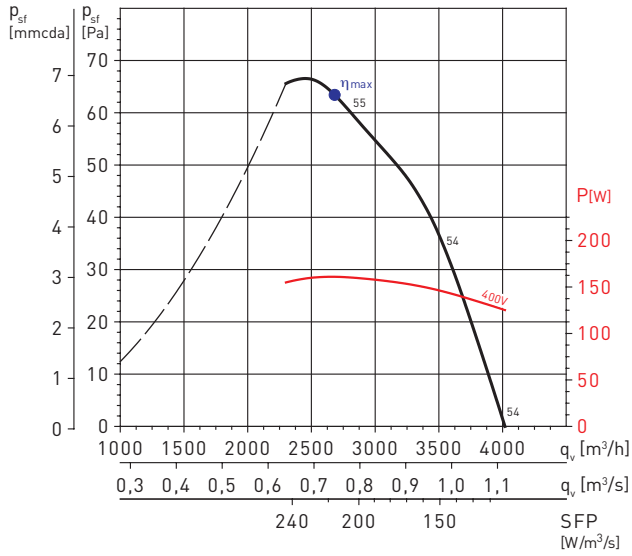

MC	EC	VSD	SR	η[%]	N	[kW]	[m³/h]	[Pa]	[RPM]
C	Static	No	1	29,1	40,4	0,161	2684	63	911

TCBT/6-500/H

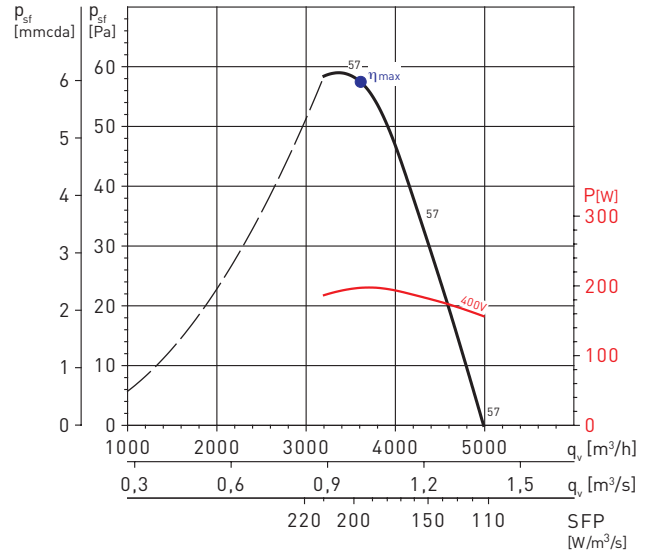

MC	EC	VSD	SR	η[%]	N	[kW]	[m³/h]	[Pa]	[RPM]
C	Static	No	1	29,2	40,0	0,197	3608	58	899

TCBT/6-560/H

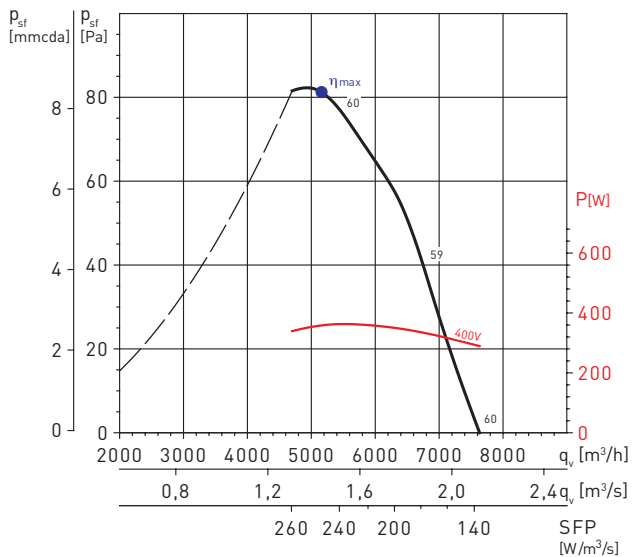

MC	EC	VSD	SR	η[%]	N	[kW]	[m³/h]	[Pa]	[RPM]
C	Static	No	1	32,5	41,6	0,359	5164	81	895

TCBT/6-630/L

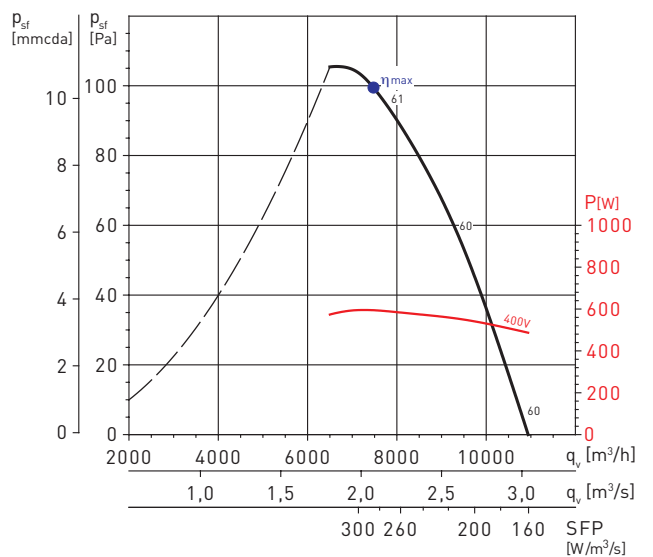

MC	EC	VSD	SR	η[%]	N	[kW]	[m³/h]	[Pa]	[RPM]
C	Static	No	1	34,6	42,4	0,594	7481	99	888

CURVAS CARACTERÍSTICAS - MOTORES DE 6 POLOS

TCBT/6-630/H

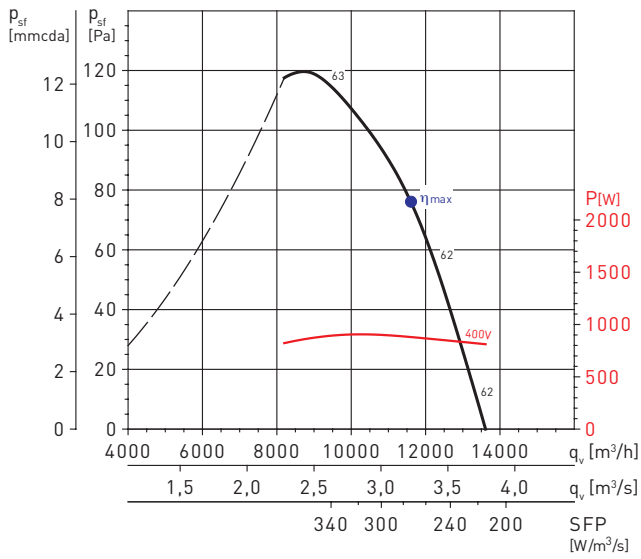

MC	EC	VSD	SR	η[%]	N	[kW]	[m³/h]	[Pa]	[RPM]
D	Total	No	1	51,7	58,4	0,880	11606	141	949

TCBT/6-710/L

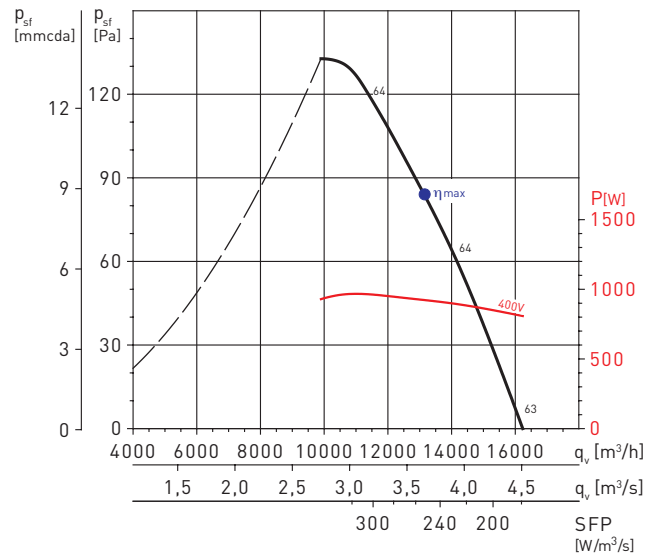

MC	EC	VSD	SR	η[%]	N	[kW]	[m³/h]	[Pa]	[RPM]
D	Total	No	1	53,7	60,3	0,921	13209	134	894

TCBT/6-710/H

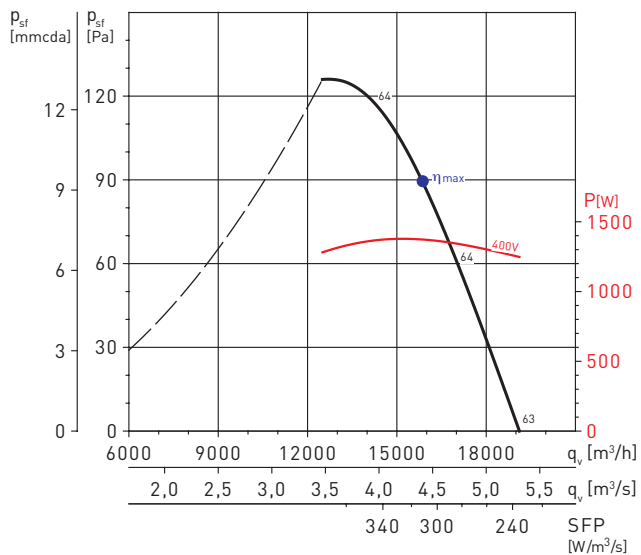

MC	EC	VSD	SR	η[%]	N	[kW]	[m³/h]	[Pa]	[RPM]
D	Total	No	1	52,7	58,2	1,376	15643	167	897

TCBT/6-800/L

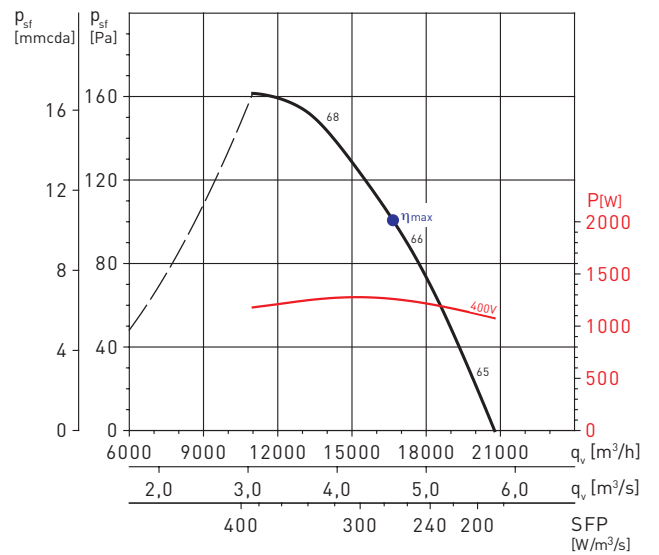

MC	EC	VSD	SR	η[%]	N	[kW]	[m³/h]	[Pa]	[RPM]
D	Total	No	1	56,0	61,7	1,260	16668	152	955

CURVAS CARACTERÍSTICAS - MOTORES DE 6 POLOS

TCBT/6-800/K

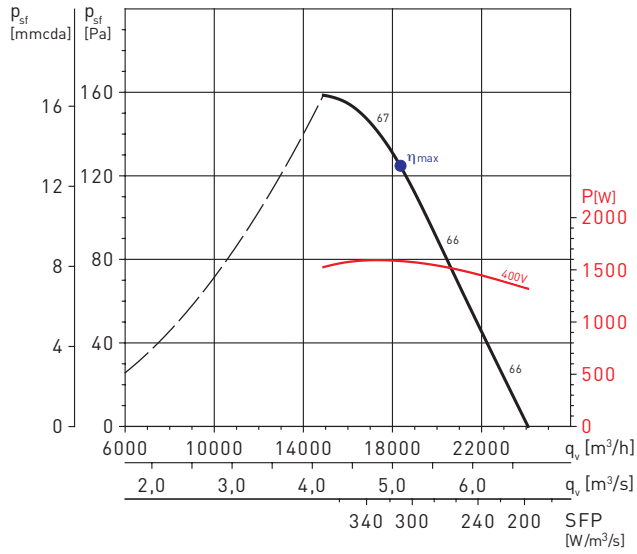

MC	EC	VSD	SR	η [%]	N	[kW]	[m³/h]	[Pa]	[RPM]
D	Total	No	1	60,1	65,2	1,584	18352	187	965

TCBT/6-800/G

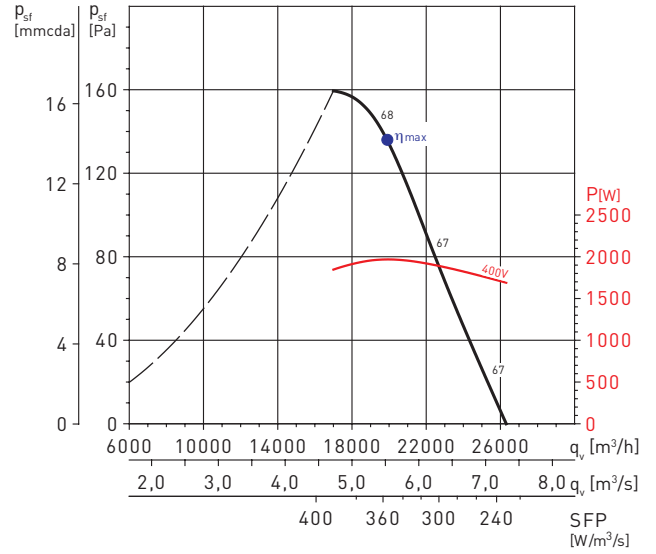

MC	EC	VSD	SR	η [%]	N	[kW]	[m³/h]	[Pa]	[RPM]
D	Total	No	1	58,6	63,1	1,968	19904	209	971

TCBT/6-800/H

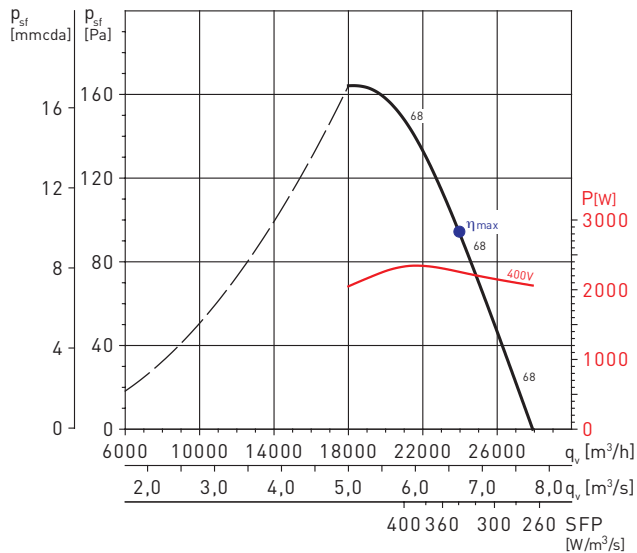

MC	EC	VSD	SR	η [%]	N	[kW]	[m³/h]	[Pa]	[RPM]
D	Total	No	1	59,0	63,1	2,257	23956	200	962